

DAIKIN



R32 SPLIT SERIES

OPERATION MANUAL

INVERTER **R32**

MODELS

- FTXTM30M2V1B
- FTXTM40M2V1B



Feature

For your comfort and energy saving



INTELLIGENT EYE

The INTELLIGENT EYE sensor detects the human movement in a room. If no one is in the room for more than 20 minutes, the operation automatically changes to energy saving operation.

▶Page 16



WEEKLY TIMER

Up to 4 timer settings can be saved for each day of the week according to your family's life style. The WEEKLY TIMER allows you to set on/off time and the desired temperature.

▶Page 25



FLASH STREAMER

Streamer and filtration technologies remove airborne allergens such as mold and pollen as well as adjuvant substances, viruses, and bacteria.

▶Page 22



FIREPLACE LOGIC

This function ensures even distribution of hot air from a fireplace or another heat source across the room.

▶Page 22

Other functions



COMFORT AIRFLOW

The airflow direction will be in upward while in COOL operation, in downward while in HEAT operation. This function will prevent cold or warm air from directly blowing on your body. ▶Page 16



OUTDOOR UNIT QUIET











OUTDOOR UNIT QUIET operation lowers the noise level of the outdoor unit. This function is useful when you need to consider the noise for your neighbourhood. ▶Page 20

Contents

■ Read before Operation

Safety Precautions	3
Name of Parts	5
Preparation before Operation	10

Operation

 AUTO · DRY · COOL · HEAT · FAN Operation	12
 Adjusting the Airflow Direction and Rate	14
 COMFORT AIRFLOW / INTELLIGENT EYE Operation	16
 POWERFUL Operation	19
 ECONO/OUTDOOR UNIT QUIET Operation	20
 FLASH STREAMER AIR PURIFYING Operation	22
 FIREPLACE LOGIC Operation	22
 OFF TIMER Operation	23
 ON TIMER Operation	24
 WEEKLY TIMER Operation	25

■ Care

Care and Cleaning	31
-------------------------	-----------

■ Troubleshooting

Troubleshooting	38
-----------------------	-----------

The English text is the original instruction. Other languages are translations of the original instructions.



ECONO

This function enables efficient operation by limiting the maximum power consumption. It is useful when using the unit and other electrical devices simultaneously. ▶Page 20

Safety Precautions



Read the precautions in this manual carefully before operating the unit.



This appliance is filled with R32.

- Keep this manual where the operator can easily find it.
- Read the precautions in this manual carefully before operating the unit.
- This appliance is intended to be used by expert or trained users in shops, in light industry and on farms, or for commercial and household use by lay persons.
- Sound pressure level is less than 70 dB (A).
- The precautions described herein are classified as WARNING and CAUTION. They both contain important information regarding safety. Be sure to observe all precautions without fail.



WARNING

Failure to follow these instructions properly may result in personal injury or loss of life.



CAUTION

Failure to observe these instructions properly may result in property damage or personal injury, which may be serious depending on the circumstances.



Never attempt.



Be sure to follow the instructions.



Be sure to establish an earth connection.

- After reading, keep this manual in a convenient place so that you can refer to it whenever necessary. If the equipment is transferred to a new user, be sure also to hand over the manual.



WARNING



- The appliance must be stored in a room without continuously operating ignition sources (for example: open flames, an operating gas appliance or an operating electric heater).
- In order to avoid fire, explosion or injury, do not operate the unit when harmful gases (e.g. flammable or corrosive) are detected near the unit.
- Be aware that prolonged, direct exposure to cool or warm air from the unit, or to air that is too cool or too warm can be harmful to your physical condition and health.
- Do not place objects, including rods, your fingers, etc., in the air inlet or outlet. Product malfunctioning, product or injury damage may result due to contact with the unit's high-speed fan blades.
- Do not attempt to repair, dismantle, reinstall or modify the unit yourself as this may result in water leakage, electric shocks or fire hazards.
- Do not use flammable spray near the unit, or otherwise fire may result.
- Do not use refrigerant other than the one indicated on the outdoor unit (R32) when installing, moving or repairing. Using other refrigerants may cause trouble or damage to the unit, and personal injury.
- To avoid electric shocks, do not operate with wet hands.
- Do not wash the unit with water, as this may result in electric shocks or fire.
- Do not place water containers (vases etc.) above the unit, as this may result in electric shocks or fire hazards.



- Beware of fire in case of refrigerant leakage. If the unit is not operating correctly, i.e. not generating cool or warm air, refrigerant leakage could be the cause. Consult your dealer for assistance. The refrigerant within the unit is safe and normally does not leak. However, in the event of a leakage, contact with a naked burner, heater or cooker may result in generation of noxious gas. Do not longer use the unit until a qualified service person confirms that the leakage has been repaired.
- Do not attempt to install or repair the unit yourself. Improper workmanship may result in water leakage, electric shocks or fire hazards. Please contact your local dealer or qualified personnel for installation and maintenance work.
- When the unit is malfunctioning (giving off a burning odour, etc.) turn off power to the unit and contact your local dealer. Continued operation under such circumstances may result in a failure, electric shocks or fire hazards.
- Be sure to install an earth leakage breaker. Failure to install the earth leakage breaker may result in electric shocks or fire.



- Be sure to earth the unit. Do not earth the unit to a utility pipe, lightning conductor or telephone earth lead. Imperfect earthing may result in electric shocks.

Safety Precautions

CAUTION



- Do not expose plants or animals directly to airflow from the unit as this may cause adverse effects.
- Do not place appliances that produce naked flames in places exposed to the airflow from the unit as this may impair combustion of the burner.
- Do not block air inlets nor outlets. Impaired airflow may result in insufficient performance or trouble.
- Do not sit on the outdoor unit, put things on the unit, or pull the unit. Doing so may cause accidents, such as falling or toppling down, thus resulting in injury, product malfunctioning, or product damage.
- Do not place objects that are susceptible to moisture directly beneath the indoor or outdoor units. Under certain conditions, condensation on the main unit or refrigerant pipes, air filter dirt or drain blockage may cause dripping, resulting in fouling or failure of the object concerned.
- After prolonged use, check the unit stand and its mounts for damage. If they are left in a damaged condition, the unit may fall and cause injury.
- To avoid injury, do not touch the air inlet or aluminium fins of the indoor or outdoor units.
- This appliance can be used by children aged from 8 years and above and persons with reduced physical, sensory or mental capabilities or lack of experience and knowledge if they have been given supervision or instruction concerning use of the appliance in a safe way and understand the hazards involved.
- Children shall not play with the appliance.
- Cleaning and user maintenance shall not be made by children without supervision.
- Avoid impacts to the indoor and outdoor units, or otherwise product damage may result.
- Do not place flammable items, such as spray cans, within 1m of the air outlet.
The spray cans may explode as a result of hot air from the indoor or outdoor units.
- Be careful not to let pets urinate on the unit. Urination on the unit may result in electric shocks or fire.
- Do not wash the unit with water, as this may result in electric shocks or fire.
- Do not place water containers (vases etc.) above the unit, as this may result in electric shocks or fire hazards.



- To avoid oxygen depletion, ensure that the room is adequately ventilated if equipment such as a burner is used together with the unit.
- Before cleaning, be sure to stop unit operation, turn off the circuit breaker or remove the power cord. Otherwise, an electric shock and injury may result.
- Only connect the unit to the specified power supply circuit. Power supplies other than the one specified may result in electric shocks, overheating and fires.
- Arrange the drain hose to ensure smooth drainage. Imperfect drainage may cause wetting of the building, furniture etc.
- Do not place objects in direct proximity of the outdoor unit and do not let leaves and other debris accumulate around the unit. Leaves are a hotbed for small animals which can enter the unit. Once in the unit, such animals can cause malfunctions, smoke or fire when making contact with electrical parts.
- Do not place objects around the indoor unit.
Doing so may have an adverse influence on the performance, product quality, and life of the unit.

Installation site.

- To install the unit in the following types of environments, consult the dealer.
 - Places with an oily environment or where steam or soot occurs.
 - Salty environment such as coastal areas.
 - Places where sulfide gas occurs such as hot springs.
 - Places where snow may block the outdoor unit.
- Be sure to follow the instructions below.
 - The indoor unit is at least 1m away from any television or radio set (unit may cause interference with the picture or sound).
 - The drain from the outdoor unit must be discharged to a place of good drainage.

Consider nuisance to your neighbours from noises.

- For installation, choose a place as described below.
 - A place solid enough to bear the weight of the unit which does not amplify the operation noise or vibration.
 - A place from where the air discharged from the outdoor unit or the operation noise will not annoy your neighbours.

Electrical work and System relocation.

- For power supply, be sure to use a separate power circuit dedicated to the unit.
- Relocating the unit requires specialized knowledge and skills. Please consult the dealer if relocation is necessary for moving or remodeling.

Name of Parts

Indoor Unit

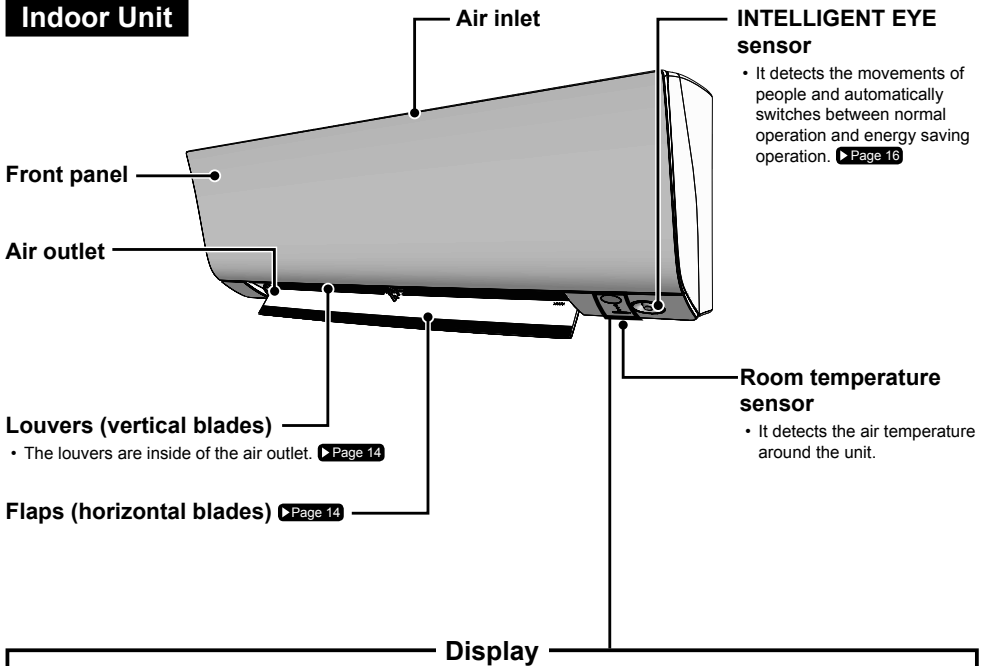

Display

Signal receiver

- It receives signals from the remote controller.
- When the unit receives a signal, you will hear a beep sound.

Case	Sound type
Operation start	beep-beep
Setting changed	beep
Operation stop	long beep

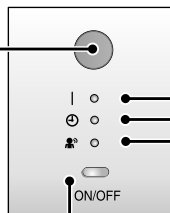

OPERATION lamp

TIMER lamp ▶Page 23,24

INTELLIGENT EYE lamp

▶Page 17

Indoor unit ON/OFF switch

- Press this switch once to start operation. Press once again to stop it.
- The operation mode refers to the following table.

Mode	Temperature setting	Airflow rate
AUTO	25°C	AUTO

- This switch is useful when the remote controller is missing.

• The appearance of the indoor unit may differ between different models

Name of Parts

FTXTM30M2V1B

■ Open the front panel

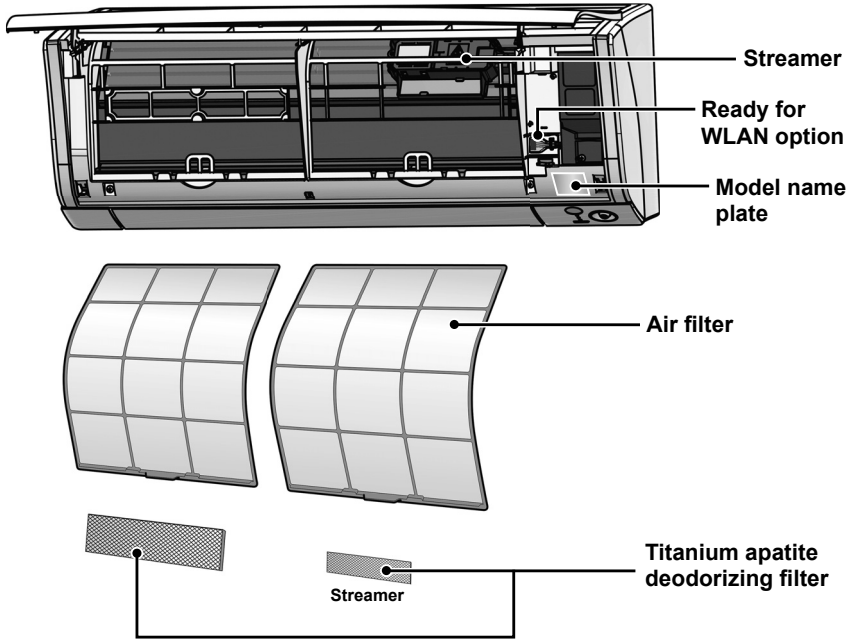

Outdoor Unit

• Appearance of the outdoor unit may differ from some models.

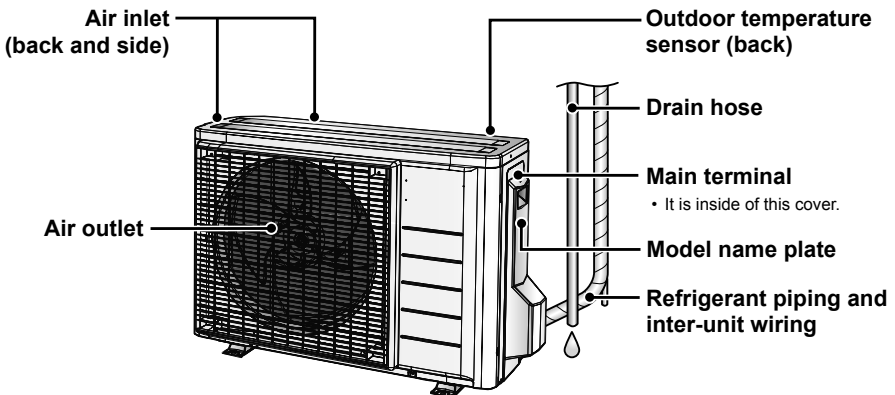

Name of Parts

FTXTM40M2V1B

■ Open the front panel

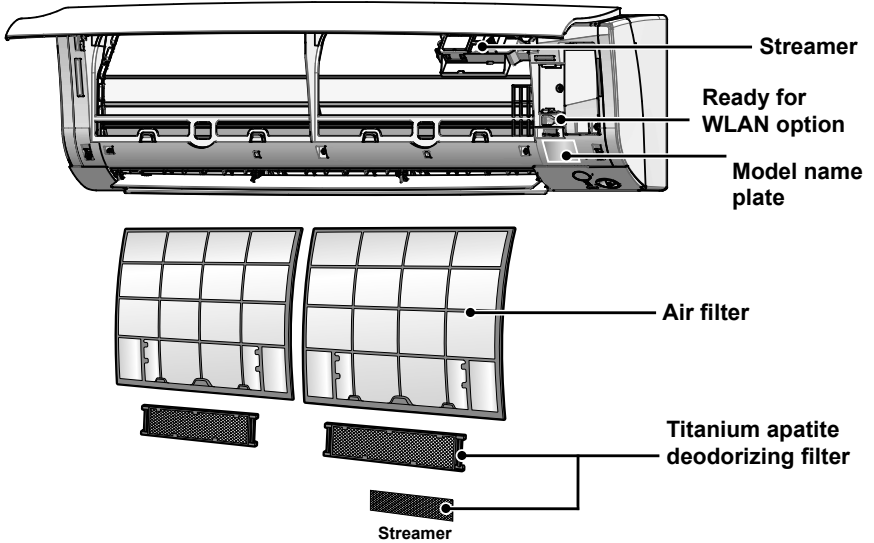

Outdoor Unit

• Appearance of the outdoor unit may differ from some models.

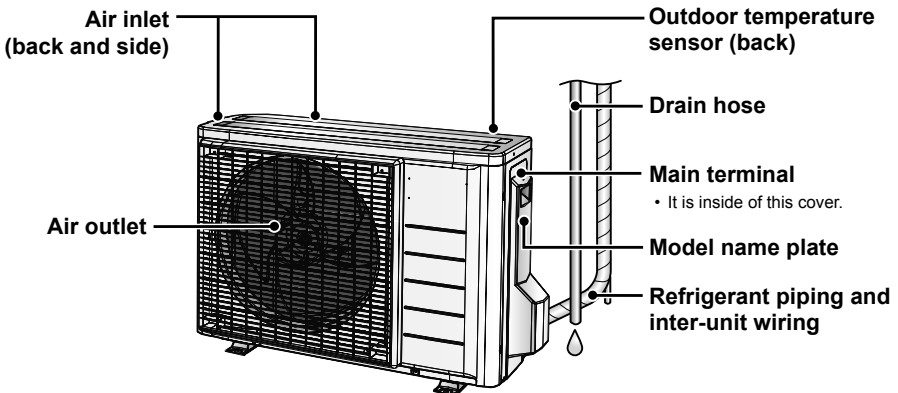

Name of Parts

Remote Controller

Signal transmitter

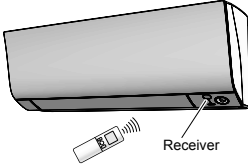

- To use the remote controller, aim the transmitter at the indoor unit. If there is anything to block signals between the unit and the remote controller, such as a curtain, the unit will not operate.
- Do not drop the remote controller. Do not get it wet.
- The maximum distance for communication is approx. 7m.

FAN setting button

- It selects the airflow rate setting. ▶ Page 15

POWERFUL button

- POWERFUL operation. ▶ Page 19

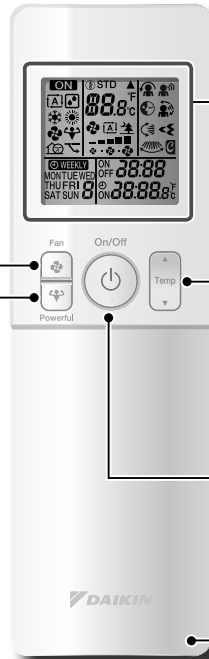

Display (LCD)

- It displays the current settings. (In this illustration, each section is shown with its displays on for the purpose of explanation.)

TEMPERATURE adjustment buttons

- It changes the temperature setting. ▶ Page 13

ON/OFF button

- Press this button once to start operation. Press once again to stop it. ▶ Page 12

Front cover

- Open the front cover. ▶ Page 9

Model ARC466A55

Name of Parts

■ Open the front cover



**FLASH STREAMER
AIR PURIFYING/
FIREPLACE LOGIC
button**

- Performs streamer and fire place logic operation. ▶Page 22

**COMFORT/SENSOR
button**

- COMFORT AIRFLOW and INTELLIGENT EYE operation. ▶Page 16

OFF TIMER button

▶Page 23

**TIMER CANCEL
button**

- It cancels the timer setting. ▶Page 23,24
- It cannot be used for the WEEKLY TIMER operation.

SELECT button

- It changes the ON/OFF TIMER and WEEKLY TIMER settings. ▶Page 23,24,25

MODE selector button

- It selects the operation mode. (AUTO/DRY/COOL/HEAT/FAN) ▶Page 12

ECONO/QUIET button

- ECONO/OUTDOOR UNIT QUIET operation. ▶Page 20

SWING button

- Adjusting the airflow direction. ▶Page 14

Weekly

Weekly : WEEKLY button

PROGRAM button

Copy : COPY button

Back : BACK button

Next : NEXT button

- WEEKLY TIMER operation. ▶Page 25

ON TIMER button

▶Page 24

CLOCK button ▶Page 11

**Lamp brightness
setting button**

▶Page 10

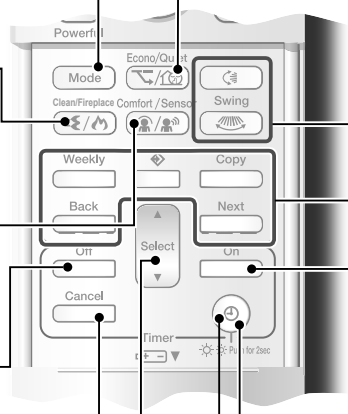

Preparation before Operation

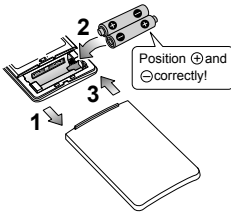

■ To set the batteries

1. Slide the front cover to take it off.
2. Set two dry batteries AAA.LR03 (alkaline).
3. Set the front cover as before.

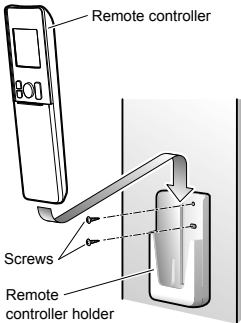

■ To fix the remote controller holder on the wall

1. Choose a place from where the signals reach the unit.
2. Fix the holder to a wall, or similar location with the screws procured locally.
3. Place the remote controller in the remote controller holder.

■ To set the luminance of the display

- The luminance of the indoor unit display can be set.

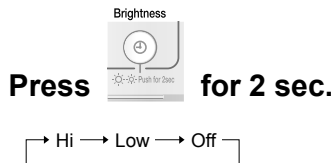

NOTE

■ Notes on batteries

- When replacing the batteries, use batteries of the same type, and replace both old batteries together.
- When the system is not used for a long time, take the batteries out.
- The batteries will last for approx. 1 year. Low energy of battery is indicated by flashing of LCD display. Replace both batteries with new, size AAA.LR03 (alkaline).
- The attached batteries are provided for the initial use of the system.
The usable period of the batteries may be short depending on the manufactured date of the unit.

■ Notes on remote controller

- Never expose the remote controller to direct sunlight.
- Dust on the signal transmitter or receiver will reduce the sensitivity. Wipe off dust with soft cloth.
- Signal communication may be disabled if an electronic-starter-type fluorescent lamp (such as inverter-type lamps) is in the room. Consult the shop if that is the case.
- If the remote controller signals happen to operate another appliance, move that appliance to somewhere else, or consult the service shop.

Preparation before Operation



■ Turn the breaker on

- After the power is turned on, the flaps of the indoor unit opens and closes once to set the reference position.

■ To set the clock

1. Press .



- "0:00" is displayed on the LCD.
- "MON" and "⏻" blink.

2. Press to set the current day of the week.

3. Press .



- "⏻" blinks.

4. Press to set the clock to the present time.

- Holding down ▲ or ▼ rapidly increases or decreases the time display.

5. Press .

- Point the remote controller at the indoor unit when pressing the buttons.



- "15:30" blinks.

NOTE

■ Note on setting the clock

- If the indoor unit's internal clock is not set to the correct time, the ON TIMER, OFF TIMER and WEEKLY TIMER will not operate punctually.



AUTO · DRY · COOL · HEAT · FAN Operation

The unit operates with the operation mode of your choice.

From the next time on, the unit will operate with the same operation mode.

■ To start operation

1. Press and select an operation mode.

- Each pressing of the button advances the mode setting in sequence.

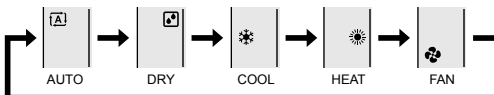

2. Press .

- "ON" is displayed on the LCD.
- The OPERATION lamp lights green.

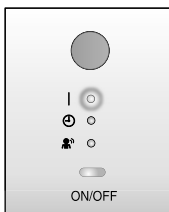

Display

■ To stop operation

Press again.

- "ON" disappears from the LCD.
- The OPERATION lamp goes off.

NOTE

MODE	Notes on each operation mode
HEAT	<ul style="list-style-type: none"> • Since this unit heats the room by taking heat from outdoor air to indoors, the heating capacity becomes smaller in lower outdoor temperatures. If the heating effect is insufficient, it is recommended to use another heating appliance in combination with the unit. • The heat pump system heats the room by circulating hot air around all parts of the room. After the start of HEAT operation, it takes some time before the room gets warmer. • In HEAT operation, frost may occur on the outdoor unit and lower the heating capacity. In that case, the system switches into defrosting operation to take away the frost. • During defrosting operation, hot air does not flow out of indoor unit.
COOL	<ul style="list-style-type: none"> • This unit cools the room by releasing the heat in the room outside. Therefore, the cooling performance of the unit may be degraded if the outdoor temperature is high
DRY	<ul style="list-style-type: none"> • The computer chip works to rid the room of humidity while maintaining the temperature as much as possible. It automatically controls temperature and airflow rate, so manual adjustment of these functions is unavailable.
AUTO	<ul style="list-style-type: none"> • In AUTO operation, the system selects an appropriate operation mode (COOL or HEAT) based on the room and outside temperatures and starts the operation. • The system automatically reselects setting at a regular interval to bring the room temperature to user-setting level.
FAN	<ul style="list-style-type: none"> • This mode is valid for fan only.



AUTO · DRY · COOL · HEAT · FAN Operation

■ To change the temperature setting



Press .

- The displayed items on the LCD will change whenever either one of the buttons is pressed.

COOL operation	HEAT operation	AUTO operation	DRY or FAN operation
18~32°C	10~30°C	18~30°C	The temperature setting is not variable.
Press ▲ to raise the temperature and press ▼ to lower the temperature.			

■ Operating conditions

■ Recommended temperature setting

- For cooling: 26~28°C
- For heating: 20~24°C

■ Tips for saving energy

- Be careful not to cool (heat) the room too much.
Keeping the temperature setting at a moderate level helps save energy.
- Cover windows with a blind or a curtain.
Blocking sunlight and air from outdoors increases the cooling (heating) effect.
- Clogged air filters cause inefficient operation and waste energy. Clean them once in about every 2 weeks.

■ Notes on the operating conditions

- The unit always consumes a small amount of electricity even while it is not operating.
- If you are not going to use the unit for a long period, for example in spring or autumn, turn the breaker off.
- Use the unit in the following conditions.

MODE	Operating conditions	If operation is continued out of this range
COOL	Outdoor temperature : -10~46°C Indoor temperature : 18~32°C Indoor humidity : 80% max.	<ul style="list-style-type: none"> • A safety device may work to stop the operation. • Condensation may occur on the indoor unit and drip.
HEAT	Outdoor temperature : -25~24°C (R.H.=55.4%) Indoor temperature : 10~30°C	<ul style="list-style-type: none"> • A safety device may work to stop the operation.
DRY	Outdoor temperature : -10~46°C Indoor temperature : 18~32°C Indoor humidity : 80% max.	<ul style="list-style-type: none"> • A safety device may work to stop the operation. • Condensation may occur on the indoor unit and drip.

- Operation outside this humidity or temperature range may cause a safety device to disable the system.



Adjusting the Airflow Direction and Rate

You can adjust the airflow direction to increase your comfort.



■ To start auto swing

Upper and lower airflow direction

Press .

- “” is displayed on the LCD.
- The flaps (horizontal blades) will begin to swing.

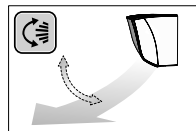

Right and left airflow direction



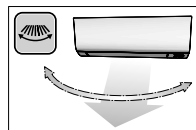

Press .

- “” is displayed on the LCD.
- The louvers (vertical blades) will begin to swing.



The 3-D airflow direction

Press  and .

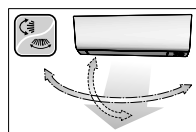

- “” and “” are displayed on the LCD.
- The flaps and louvers move in turn.
- To cancel 3-D airflow, press either  or  again. The flaps or louvers will stop moving.



■ To set the flaps or louvers at desired position

- This function is effective while flaps or louvers are in auto swing mode.

Press  and  when the flaps or louvers have reached the desired position.

- In the 3-D airflow, the flaps and louvers move in turn.
- “” or “” disappears from the LCD.



Adjusting the Airflow Direction and Rate

■ To adjust the airflow rate setting



Press  .

- Each pressing of  advances the airflow rate setting in sequence.

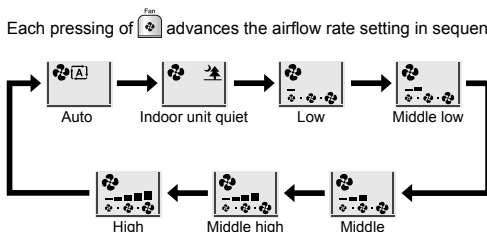

- When the airflow is set to "  ", indoor unit quiet operation will start and the noise from the unit will become quieter.
- In indoor unit quiet operation, the airflow rate is set to a weak level.
- If the temperature does not reach the desired point, change the airflow rate setting.
- In DRY mode, the airflow rate setting is not variable.

If the temperature does reach the desired point:

- Fan will stop operating in COOL / AUTO operation mode.
- Fan will start to operate in middle low speed in HEAT operation mode.
- The air flow rate will be lowered in the HEAT mode to avoid generating cold air flow. When the temperature of the air flow rise, operation will continue at the desired air flow rate.

NOTE

Notes on airflow direction setting

- The movable range of the flap varies according to the operation mode.
- The flap will stop at the upper position when the airflow rate is changed to low during the up and down swing setting.

Notes on airflow direction setting

- Using 3/D airflow circulates cold air, which tends to collect at the bottom of the room, and hot air, which tends to collect near the ceiling, throughout the room, preventing areas of cold and hot developing.

Notes on airflow rate setting

- At smaller airflow rates, the cooling (heating) effect is also smaller.

Movable range of the flap

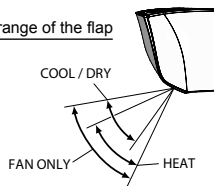

CAUTION

- Always use a remote controller to adjust the angles of the flaps and louvers. If you attempt to move the flaps and louvers forcibly with hand when they are swinging, the mechanism may be broken.
- Always use a remote controller to adjust the louvers angles. Inside the air outlet, a fan is rotating at a high speed.



COMFORT AIRFLOW / INTELLIGENT EYE Operation

■ COMFORT AIRFLOW operation

The flow of air will be in the upward direction while in COOL operation and in the downward direction while in HEAT operation, which will provide a comfortable wind that will not come in direct contact with people.

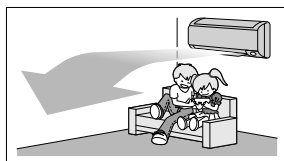

COOL operation

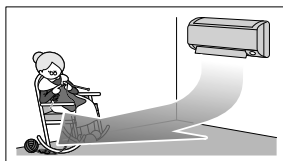

HEAT operation

■ INTELLIGENT EYE operation

"INTELLIGENT EYE" is the infrared sensor which detects the human movement. If no one is in the room for more than 20 minutes, the operation automatically changes to energy saving operation.

The INTELLIGENT EYE sensor according to the following situations.

■ A person is detected in area 1.

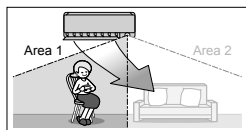

■ A person is detected in area 2.

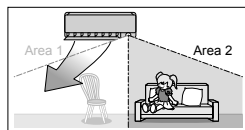

■ People are detected in both areas.

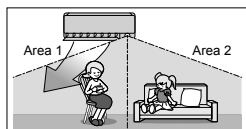

■ No people are detected in the areas.

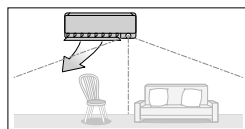

Use the INTELLIGENT EYE operation in combination with the COMFORT AIRFLOW operation.

The unit will go into energy-saving mode after 20 minutes.

*The wind direction may differ from the illustrated direction depending on the actions and movements of the people in the areas.

INTELLIGENT EYE operation is useful for energy saving

■ Energy saving operation

- If no presence detected in the room for 20 minutes, the energy saving operation will start.
- This operation changes the temperature -2°C in HEAT / $+2^{\circ}\text{C}$ in COOL / $+2^{\circ}\text{C}$ in DRY operation from set temperature. When the room temperature exceeds 30°C , the operation changes the temperature $+1^{\circ}\text{C}$ in COOL / $+1^{\circ}\text{C}$ in DRY operation from set temperature.
- This operation decreases the airflow rate slightly in FAN operation only.

■ Combination COMFORT AIRFLOW and INTELLIGENT EYE operation

The unit can go into operation with the COMFORT AIRFLOW and INTELLIGENT EYE operations combined.



COMFORT AIRFLOW / INTELLIGENT EYE Operation

■ To start operation



Comfort / Sensor

Press  and select the desired mode.

- Each time the  is pressed a different setting option is displayed on the LCD.
- The INTELLIGENT EYE lamp lights green.



Display

- By selecting “” from the following icons, the unit will be in COMFORT AIRFLOW operation combined with INTELLIGENT EYE operation.

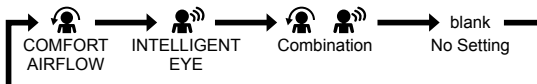



- When the flaps (horizontal blades) are swinging, the operating as above will stop movement of them.
- The lamp will be lit while human movements are detected.

■ To cancel operation

Comfort / Sensor

Press  and select “blank” on the LCD.

- The INTELLIGENT EYE lamp goes off.

Display	Operation mode	Explanation
	COMFORT AIRFLOW	The flaps will adjust the airflow direction upward while cooling, and adjust the airflow direction downward while heating. ▶Page 16
	INTELLIGENT EYE	The sensors will detect the movement of people in the sensing areas and the louvers will adjust the airflow direction to an area where people are not present. When there are no people in the sensing areas, the unit will go into energy-saving mode. ▶Page 16
	COMFORT AIRFLOW and INTELLIGENT EYE	The unit will be in COMFORT AIRFLOW operation combined with INTELLIGENT EYE operation. ▶Page 16
Blank	No function	-



COMFORT AIRFLOW / INTELLIGENT EYE Operation

NOTE

■ Notes on COMFORT AIRFLOW operation

- The flaps position will change, preventing air from blowing directly on the occupants of the room.
- POWERFUL operation and COMFORT AIRFLOW operation cannot be used at the same time. Priority is given to the function of whichever button is pressed last.
- The airflow rate will be set to AUTO. If the upper and lower airflow direction is selected, the COMFORT AIRFLOW operation will be canceled.

■ Notes on INTELLIGENT EYE operation

- Application range is as follows.

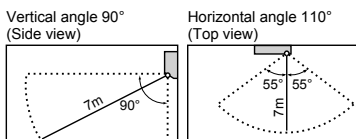

- While the unit is in INTELLIGENT EYE operation, the louvers will adjust the airflow direction if there are people in the sensing areas of the INTELLIGENT EYE so that the leftward or rightward airflow will not be directed to the people. If no people are detected in either area 1 or 2 in 20 minutes, the unit will go into energy-saving mode with the set temperature shifted by 2°C.

The unit may go into energy-saving operation even if there are people in the areas.

This may occur depending on the clothes the people are wearing if there are no movements of the people in the areas.

- The airflow direction from the louvers will be leftward if there are people in both areas 1 and 2 or if there is a person right in front of the sensors because the sensors on the both sides will detect the person.
- Due to the position of the sensor, people might be exposed to the airflow of the indoor unit if they are close to the front side of the indoor unit. If there are people close to the front side of the indoor unit or in both areas, it is recommended to use the COMFORT AIRFLOW and INTELLIGENT EYE operations simultaneously. When both of them are in use, the unit will not direct the airflow towards the people.
- Sensor may not detect moving objects further than 7m away. (Check the application range.)
- Sensor detection sensitivity changes according to indoor unit location, the speed of passersby, temperature range, etc.
- The sensor also mistakenly detects pets, sunlight, fluttering curtains and light reflected off of mirrors as passersby.
- INTELLIGENT EYE operation will not go on during POWERFUL operation.
- NIGHT SET mode [▶Page 23](#) will not go on during use of INTELLIGENT EYE operation.

■ Notes on combination of COMFORT AIRFLOW operation and INTELLIGENT EYE operation

- The airflow rate will be set to AUTO. If the upper and lower airflow direction is selected, the COMFORT AIRFLOW operation will be canceled. Priority is given to the function of whichever button is pressed last.
- The flaps adjust the airflow direction upward (while in COOL operation) and downward (while in HEAT operation), during which the sensors of the INTELLIGENT EYE are working to detect the movement of people. When the sensors detect people, the louvers will direct the airflow in such way that it will not be blown directly on them. If there are no people, the unit will go into energy-saving operation after 20 minutes.

CAUTION

- Do not place large objects near the sensor.
- Also keep heating units or humidifiers outside the sensor's detection area. This sensor can detect undesirable objects.
- Do not hit or violently push the INTELLIGENT EYE sensor. This can lead to damage and malfunction.



POWERFUL Operation



POWERFUL operation quickly maximises the cooling (heating) effect in any operation modes. You can get the maximum capacity.

■ To start POWERFUL operation

Press  during operation.

- POWERFUL operation ends in 20 minutes. Then the system automatically operates again with the previous settings which were used before POWERFUL operation.
- “” is displayed on the LCD.

■ To cancel POWERFUL operation

Press  again.

- “” disappears from the LCD.

[Example]



■ **Normal operation**

- When you want to get the cooling effect quickly, start the POWERFUL operation.

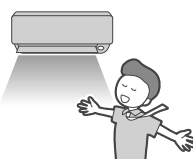

■ **POWERFUL operation**

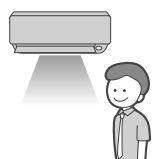

- POWERFUL operation will work for 20 minutes.



■ **Back to normal operation**

NOTE

■ Notes on POWERFUL operation

- When using POWERFUL operation, there are some functions which are not available.
- POWERFUL operation cannot be used together with ECONO, COMFORT AIRFLOW or OUTDOOR UNIT QUIET operation. Priority is given to the function of whichever button is pressed last.
- POWERFUL operation can only be set when the unit is running. Pressing  causes the settings to be canceled, and “” disappears from the LCD.
- POWERFUL operation will not increase the capacity of the unit if the unit is already in operation with its maximum capacity demonstrated.
- **In COOL and HEAT operation**
To maximize the cooling (heating) effect, the capacity of outdoor unit is increased and the airflow rate is fixed to the maximum setting. The temperature and airflow settings are not variable.
- **In DRY operation**
The temperature setting is lowered by 2.5°C and the airflow rate is slightly increased.
- **In FAN operation**
The airflow rate is fixed to the maximum setting.
- **In AUTO operation**
To maximize the cooling (heating) effect, the capacity of outdoor unit is increased and the airflow rate is fixed to the maximum setting.



ECONO/OUTDOOR UNIT QUIET Operation

■ ECONO operation

ECONO operation is a function which enables efficient operation by limiting the maximum power consumption value.

This function is useful for cases in which attention should be paid to ensure a circuit breaker will not trip when the product runs alongside other appliances.

[Example]

Normal operation



- In case the unit and other appliances which require high power consumption are used at same time, a circuit breaker may trip if the unit operate with its maximum capacity.

ECONO operation



- The maximum power consumption of the unit is limited by using ECONO operation. The circuit breaker will hardly trip even if the unit and other appliances are used at same time.

Running current and power consumption

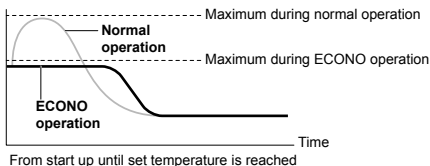

- This diagram is a representation for illustrative purposes only. The maximum running current and power consumption of the unit in ECONO operation vary with the connecting outdoor unit.

■ OUTDOOR UNIT QUIET operation

OUTDOOR UNIT QUIET operation lowers the noise level of the outdoor unit by changing the frequency and fan speed on the outdoor unit. This function is convenient during the night.

[Example] Using the OUTDOOR UNIT QUIET operation during the night.

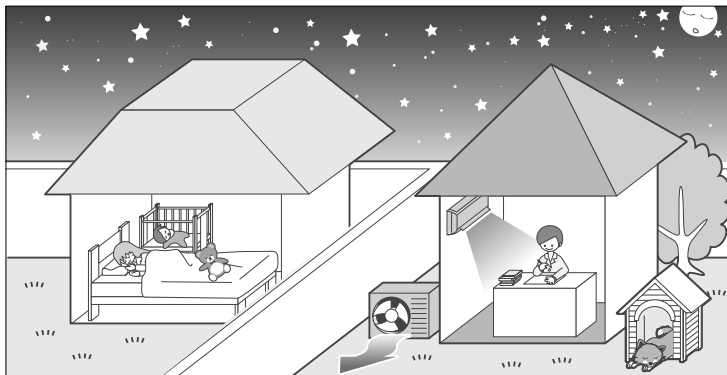

- The noise level of the outdoor unit will be lower. This function is useful when you need to consider the noise for your neighbourhood.



ECONO/OUTDOOR UNIT QUIET Operation

■ To start operation

Press  and select the desired mode.

- Each time the  is pressed a different setting option is displayed on the LCD.





■ To cancel operation

Press  and select “blank” on the LCD.



NOTE

■ Notes on ECONO operation

- ECONO operation can only be set when the unit is running. Pressing  causes the settings to be canceled, and “” disappears from the LCD.
- ECONO operation is a function which enables efficient operation by limiting the power consumption of the outdoor unit (operating frequency).
- ECONO operation functions in AUTO, COOL, DRY, and HEAT operation.
- POWERFUL and ECONO operation cannot be used at the same time. Priority is given to the function of whichever button is pressed last.
- If the level of power consumption is already low, ECONO operation will not drop the power consumption.

■ Notes on OUTDOOR UNIT QUIET operation

- This function is available in COOL, HEAT, and AUTO operation. This is not available in FAN and DRY operation.
- POWERFUL operation and OUTDOOR UNIT QUIET operation cannot be used at the same time. Priority is given to the function of whichever button is pressed last.
- Even the operation is stopped by using the remote controller or the indoor unit ON/OFF switch when using OUTDOOR UNIT QUIET operation, “” will remain on the remote controller display.
- OUTDOOR UNIT QUIET operation will drop neither the frequency nor fan speed if they have been already dropped low enough.



FLASH STREAMER AIR PURIFYING and FIREPLACE LOGIC Operation

FLASH STREAMER AIR PURIFYING Operation

The absorption power of the Titanium apatite deodorizing filter and air supply filter and the resolving power of the streamer discharge reduce bad odors and viruses, cleaning the room air.

What is streamer discharge?

- It generates high-speed electron with high oxidizing power in the unit to resolve odor and harmful gas. (It is safe because the high-speed electron is generated and goes away inside the unit.)
- The streamer discharge fizzes, but this is not a malfunction.

NOTE

■ FLASH STREAMER AIR PURIFYING operation

- The streamer discharge energy and Titanium apatite deodorizing filter clean the air in the room.
- When the airflow becomes weak during operation, the streamer discharge may stop temporarily to prevent a small amount of ozone smell coming from the air outlet.

HOT AIR FIREPLACE LOGIC - heating mode only

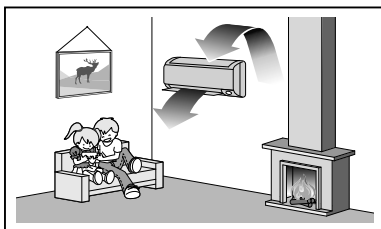

Fireplace logic support equal distribution from external heat source, such as fire place, across the room.

How it works?

If the temperature in the room reaches the desired point set by user, the operation FIREPLACE LOGIC will start automatically. The unit will distribute hot air from the external source across the room using the unit's fan.

The fan speed and the intensity of distribution depends on difference between temperature set by user and actual temperature in the room (in case of big difference between these temperatures the air distribution will be more intensive).

■ To start operation

- For heating mode

Press and select the desired mode.

- Each time the is pressed the different symbol will appear in the remote controller's display.

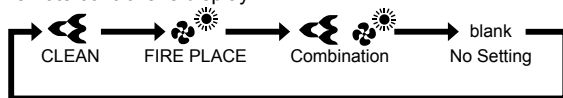

- For Auto / Cooling / Fan / Dry mode

Press

- "" Is displayed

■ To cancel operation

Press and select "blank" on the LCD.





OFF TIMER Operation



Timer functions are useful for automatically switching the unit on or off at night or in the morning. You can also use OFF TIMER and ON TIMER in combination.

■ To use OFF TIMER operation

- Check that the clock is correct.
If not, set the clock to the present time. [▶Page 11](#)

1. Press **.**



- "0:00" is displayed on the LCD.
- "OFF" blinks.

- "⊕" and day of the week disappear from the LCD.

2. Press **until the time setting reaches the point you like.**

- Each pressing of either button increases or decreases the time setting by 10 minutes.
Holding down either button changes the time setting rapidly.

3. Press **again.**

- "OFF" and setting time are displayed on the LCD.
- The TIMER lamp lights yellow. [▶Page 5](#)



Display

■ To cancel OFF TIMER operation

Press **.**

- "OFF" and setting time disappear from the LCD.
- "⊕" and day of the week are displayed on the LCD.
- The TIMER lamp goes off.

NOTE

■ Notes on TIMER operation

- When TIMER is set, the present time is not displayed.
- Once you set ON/OFF TIMER, the time setting is kept in the memory. The memory is canceled when remote controller batteries are replaced.
- When operating the unit via the ON/OFF TIMER, the actual length of operation may vary from the time entered by the user. (Maximum approx. 10 minutes)

■ NIGHT SET mode

- When the OFF TIMER is set, the unit automatically adjusts the temperature setting (0.5°C up in COOL, 2.0°C down in HEAT) to prevent excessive cooling (heating) for your pleasant sleep.



■ To use ON TIMER operation

- Check that the clock is correct.
If not, set the clock to the present time. ▶Page 11

1. Press .



- " 6:00 " is displayed on the LCD.
- " ON " blinks.

- " ⊕ " and day of the week disappear from the LCD.

2. Press until the time setting reaches the point you like.

- Each pressing of either button increases or decreases the time setting by 10 minutes.
Holding down either button changes the setting rapidly.

3. Press again.

- " ON " and setting time are displayed on the LCD.
- The TIMER lamp lights yellow. ▶Page 5



Display

■ To cancel ON TIMER operation

Press .

- " ON " and setting time disappear from the LCD.
- " ⊕ " and day of the week are displayed on the LCD.
- The TIMER lamp goes off.

■ To combine ON TIMER and OFF TIMER

- A sample setting for combining the 2 timers is shown below.

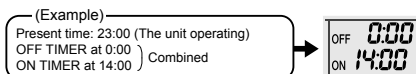

NOTE

■ In the following cases, set the timer again.

- After a breaker has turned off.
- After a power failure.
- After replacing batteries in the remote controller.



WEEKLY TIMER Operation

Up to 4 timer settings can be saved for each day of the week. It is convenient if the WEEKLY TIMER is set according to the family's life style.

■ Using in these cases of WEEKLY TIMER

Example: The same timer settings are made for the week from Monday through Friday while different timer settings are made for the weekend.

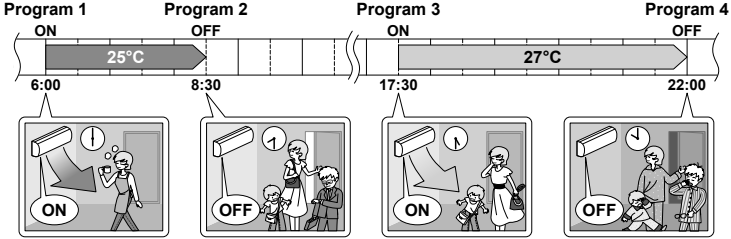
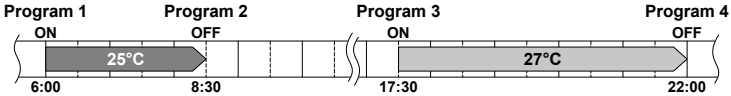
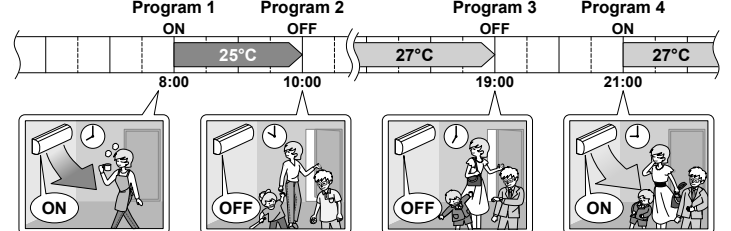
[Monday]	Make timer settings up to programs 1-4. ▶Page 26 
[Tuesday] to [Friday]	Use the copy mode to make settings for Tuesday to Friday, because these settings are the same as those for Monday. ▶Page 28 
[Saturday]	No timer settings
[Sunday]	Make timer settings up to programs 1-4. ▶Page 26 

- Up to 4 reservations per day and 28 reservations per week can be set in the WEEKLY TIMER. The effective use of the copy mode ensures ease of making reservations.
- The use of ON-ON-ON-ON settings, for example, makes it possible to schedule operating mode and set temperature changes. Furthermore, by using OFF-OFF-OFF-OFF settings, only the turn off time of each day can be set. This will turn off the unit automatically if the user forgets to turn it off.



WEEKLY TIMER Operation

■ To use WEEKLY TIMER operation

Setting mode

- Make sure the day of the week and time are set. If not, set the day of the week and time.

▶Page 11

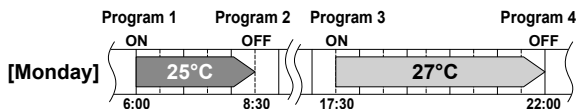

Setting Displays

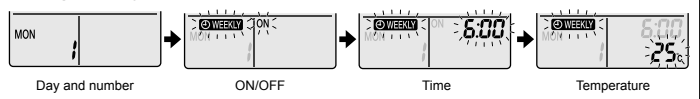

1. Press .

- The day of the week and the reservation number of the current day will be displayed.
- 1 to 4 settings can be made per day.

2. Press to select the desired day of the week and reservation number.

- Pressing changes the reservation number and the day of the week.

3. Press .

- The day of the week and reservation number will be set.
- "WEEKLY" and "ON" blink.

4. Press to select the desired mode.

- Pressing changes "ON" or "OFF" setting in sequence.

Pressing alternates the following items appearing on the LCD in rotational sequence.



- In case the reservation has already been set, selecting "blank" deletes the reservation.
- Go to step 9 if "blank" is selected.
- To return to the day of the week and reservation number setting, press .

5. Press .

- The ON/OFF TIMER mode will be set.
- "WEEKLY" and the time blink.



WEEKLY TIMER Operation



6. Press to select the desired time.

- The time can be set between 0:00 and 23:50 in 10 minute intervals.
- To return to the ON/OFF TIMER mode setting, press .
- Go to step 9 when setting the OFF TIMER.

7. Press .

- The time will be set.
- "WEEKLY" and the temperature blink.

8. Press to select the desired temperature.

- The temperature can be set between 10°C and 32°C.
COOL or AUTO: The unit operates at 18°C even if it is set at 10 to 17°C.
HEAT or AUTO: The unit operates at 30°C even if it is set at 31 to 32°C.
- To return to the time setting, press .
- The set temperature is only displayed when the mode setting is on.

9. Press .

- Be sure to direct the remote controller toward the indoor unit and check for a receiving tone and flashing the OPERATION lamp.
- The temperature is set while in ON TIMER operation, and the time is set while in OFF TIMER operation.
- The next reservation screen will appear.
- To continue further settings, repeat the procedure from step 4.
- The TIMER lamp lights yellow. 





Display

10. Press to complete the setting.

- "WEEKLY" is displayed on the LCD and WEEKLY TIMER operation is activated.
- A reservation made once can be easily copied and the same settings used for another day of the week. Refer to copy mode. 

NOTE

■ Notes on WEEKLY TIMER operation

- Do not forget to set the clock on the remote controller first. 
- The day of the week, ON/OFF TIMER mode, time and set temperature (only for ON TIMER mode) can be set with WEEKLY TIMER. Other settings for ON TIMER are based on the settings just before the operation.
- Both WEEKLY TIMER and ON/OFF TIMER operation cannot be used at the same time. The ON/OFF TIMER operation has priority if it is set while WEEKLY TIMER is still active. The WEEKLY TIMER will go into standby state, and "WEEKLY" will disappear from the LCD. When ON/OFF TIMER is up, the WEEKLY TIMER will automatically become active.
- Shutting the breaker off, power failure, and other similar events will render operation of the indoor unit's internal clock inaccurate. Reset the clock. 



WEEKLY TIMER Operation



Copy mode

• A reservation made once can be copied to another day of the week. The whole reservation of the selected day of the week will be copied.

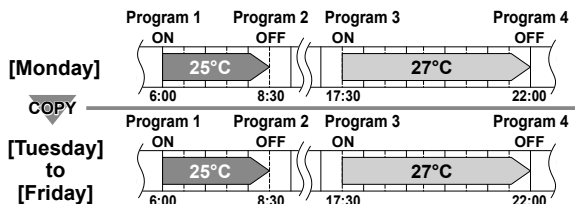

Setting Displays

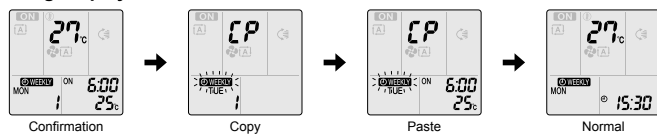

1. Press

2. Press to confirm the day of the week to be copied.

3. Press .

• The whole reservation of the selected day of the week will be copied.

4. Press to select the destination day of the week.

5. Press .

- Be sure to direct the remote controller toward the indoor unit and check for a receiving tone and flashing the OPERATION lamp.
- The reservation will be copied to the selected day of the week. The whole reservation of the selected day of the week will be copied.
- To continue copying the settings to other days of the week, repeat step 4 and step 5.
- The TIMER lamp lights yellow.

6. Press to complete the setting.

• "WEEKLY" is displayed on the LCD and WEEKLY TIMER operation is activated.

NOTE

■ Note on copy mode

- The entire reservation of the source day of the week is copied in the copy mode.

In the case of making a reservation change for any day of the week individually after copying the content of weekly reservations, press and change the settings in the steps of setting mode. [▶ Page 26](#)



WEEKLY TIMER Operation



■ Confirming a reservation

- The reservation can be confirmed.

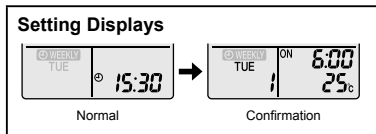

1. Press .

- The day of the week and the reservation number of the current day will be displayed.

2. Press to select the day of the week and the reservation number to be confirmed.

- Pressing  displays the reservation details.



- To change the confirmed reserved settings, select the reservation number and press .

The mode is switched to setting mode. Go to setting mode step 2. [▶ Page 26](#)

3. Press to exit confirming mode.

■ To deactivate WEEKLY TIMER operation

Press  while “ WEEKLY” is displayed on the LCD.

- The “ WEEKLY” will disappear from the LCD.
- The TIMER lamp goes off.
- To reactivate the WEEKLY TIMER operation, press  again.
- If a reservation deactivated with  is activated once again, the last reservation mode will be used.

! CAUTION

- If not all the reservation settings are reflected, deactivate the WEEKLY TIMER operation once. Then press  again to reactivate the WEEKLY TIMER operation.



WEEKLY TIMER Operation



■ To delete reservations

The individual reservation

1. Press .
 - The day of the week and the reservation number will be displayed.
2. Press to select the day of the week and the reservation number to be deleted.
3. Press .
 - "WEEKLY" and "ON" or "OFF" blink.
4. Press and select "blank".
 - Pressing changes ON/OFF TIMER mode.
 - Pressing alternates the following items appearing on the LCD in rotational sequence.
 - The reservation will be no setting with selecting "blank".



5. Press .
 - The selected reservation will be deleted.
6. Press .
 - If there are still other reservations, WEEKLY TIMER operation will be activated.

The reservations for each day of the week

- This function can be used for deleting reservations for each day of the week.
- It can be used while confirming or setting reservations.

1. Press to select the day of the week to be deleted.
2. Hold for 5 seconds.
 - The reservation of the selected day of the week will be deleted.

All reservations

Hold for 5 seconds while normal display.

- Be sure to direct the remote controller toward the indoor unit and check for a receiving tone.
- This operation is not effective while WEEKLY TIMER is being set.
- All reservations will be deleted.

Care and Cleaning

FTXTM30M2V1B

■ Quick reference

How to open / close the front panel

- Hold both ends of the front panel, and then pull to open it.
- Press the front panel at both sides and the center to close it.

Cleaning parts

Front panel

- Wipe it with a soft cloth soaked in water.

If bothered by dirt

▶ Page 33

Air filter

- Vacuum dust or wash the filter.

Once every 2 weeks

▶ Page 34

Titanium apatite deodorizing filter

- Vacuum dust or replace the filter.

[Cleaning]

Once every 6 months

▶ Page 35

[Replacement]

Once every 3 years

▶ Page 35

Indoor unit and remote controller

- Wipe them with soft cloth.

If bothered by dirt

Notes on cleaning

■ For cleaning, do not use the materials as follows.

- Hot water above 40°C.
- Benzine, gasoline, thinner, other volatile oils.
- Polishing compound.
- Scrubbing brushes, other hard stuff.



⚠ CAUTION

- Before cleaning, be sure to stop the operation and turn the breaker off.
- Do not touch the aluminium fins of the indoor unit. If you touch those parts, this may cause an injury.

Care and Cleaning

FTXTM40M2V1B

■ Quick reference

How to open / close the front panel

- Hold both ends of the front panel, and then pull to open it.
- Press the front panel at both sides and the center to close it.

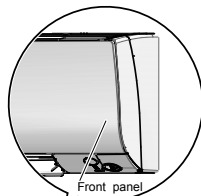

Cleaning parts

Front panel

- Wipe it with a soft cloth soaked in water.

If bothered by dirt

▶ Page 33

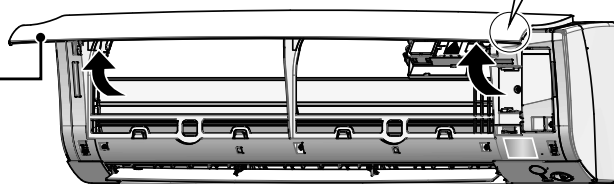

Air filter

- Vacuum dust or wash the filter.

Once every 2 weeks

▶ Page 34

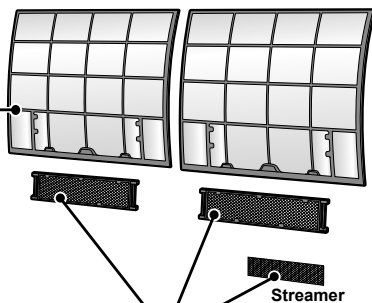

Titanium apatite deodorizing filter

- Vacuum dust or replace the filter.

[Cleaning]

Once every 6 months

▶ Page 36

[Replacement]

Once every 3 years

▶ Page 36

Indoor unit and remote controller

- Wipe them with soft cloth.

If bothered by dirt

Notes on cleaning

■ For cleaning, do not use the materials as follows.

- Hot water above 40°C.
- Benzene, gasoline, thinner, other volatile oils.
- Polishing compound.
- Scrubbing brushes, other hard stuff.



⚠ CAUTION

- Before cleaning, be sure to stop the operation and turn the breaker off.
- Do not touch the aluminium fins of the indoor unit. If you touch those parts, this may cause an injury.

Care and Cleaning

■ Removing the front panel

1. Remove the front panel.

- Slide the front panel to either the left or right and pulling it toward you. This will disconnect the rotation dowel on one side.
- Disconnect the front panel shaft on the other side in the same manner.

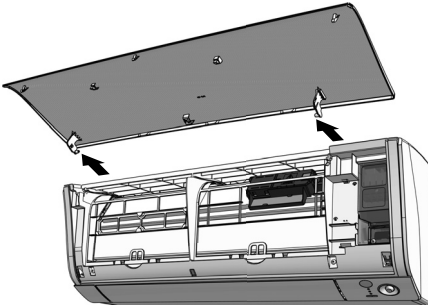
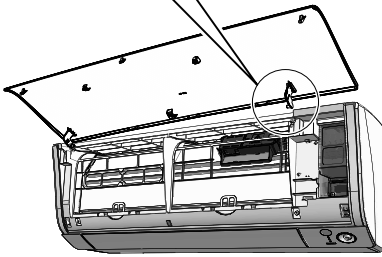
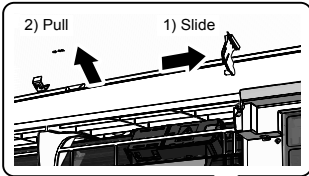

2. Clean the front panel.

- Wipe it with a soft cloth soaked in water.
- Only neutral detergent may be used.
- In case of washing the panel with water, wipe it with dry soft cloth, dry it up in the shade after washing.

3. Attach the front panel.

- Align the front panel shaft on the left and right of the front panel with the slots, then push them all the way in.

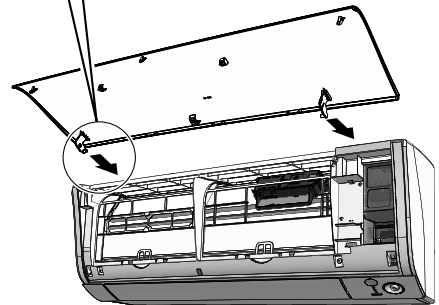
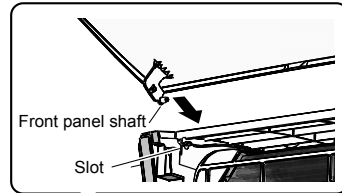

- Close the front panel slowly.
- Press the front panel at both sides and the center.

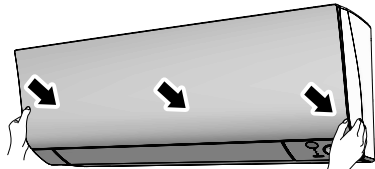

CAUTION

- When removing or attaching the front panel, use a robust and stable stool and watch your steps carefully.
- When removing or attaching the front panel, support the panel securely with hand to prevent it from falling.
- After cleaning, make sure that the front panel is securely fixed.

Care and Cleaning

■ Air filter

1. Pull out the air filters.

- Open the front panel.
- Push a little upwards the filter tab at the center of each air filter, then pull it down.

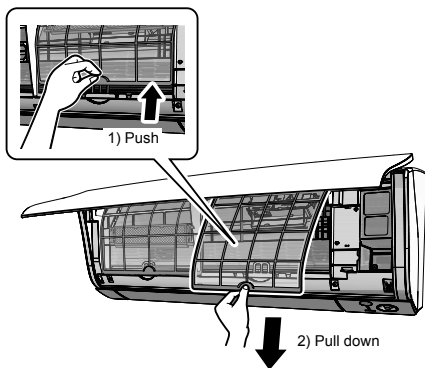

2. Wash the air filters with water or clean them with vacuum cleaner.

- Be sure to remove the Titanium apatite deodorizing filter. Refer to Titanium apatite deodorizing filter on the next page.
- It is recommended to clean the air filters every 2 weeks.

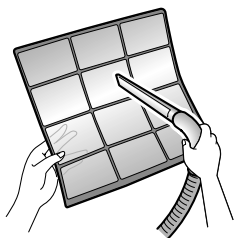

If the dust does not come off easily

- Wash the air filters with neutral detergent thinned with lukewarm water, then dry them up in the shade.



3. Set the filters as they were and close the front panel.

- Press the front panel at both sides and the center.

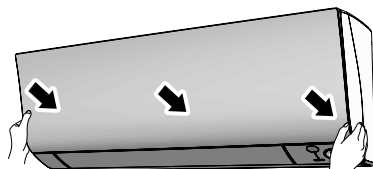

⚠ CAUTION

- Do not touch the aluminium fins by bare hand at the time of dismantling or mounting the filter.

Care and Cleaning

FTXTM30M2V1B

■ Titanium apatite deodorizing filter

1. Open the front panel and pull out the air filters. ▶Page 31

2. Take off the Titanium apatite deodorizing filter.

- Remove the filters from the tabs.

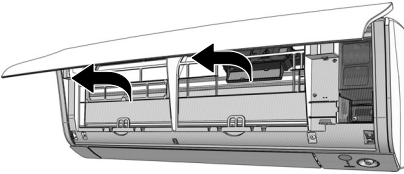

3. Clean or replace the Titanium apatite deodorizing filter.

[Cleaning]

3-1 Vacuum dust, and soak in lukewarm water or water for about 10 to 15 minutes if very dirty.

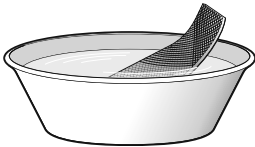

3-2 After washing, shake off remaining water and let them dry in the shade.

- Do not wring out the filter to remove water from it.

[Replacement]

Remove the filter from the tabs and prepare a new one.

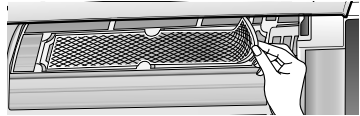

- Dispose of the old filter as non-flammable waste.

4. Insert the Titanium apatite deodorizing filter as they were.

- When attaching the filter, check that the filter is properly set in the tabs.

5. Reattach the filters. ▶Page 34

6. Close the front panel slowly. ▶Page 34

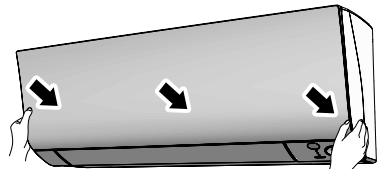

NOTE

- Operation with dirty filters:
 - cannot deodorize the air,
 - cannot clean the air,
 - results in poor heating or cooling,
 - may cause odor.
- Dispose of old filters as non-flammable waste.
- To order a Titanium apatite deodorizing filter, contact the dealer where you bought the unit.

Care and Cleaning

FTXTM40M2V1B

■ Titanium apatite deodorizing filter

1. Open the front panel and pull out the air filters. ▶Page 32

2. Take off the Titanium apatite deodorizing filter.

- Remove the filters from the tabs.

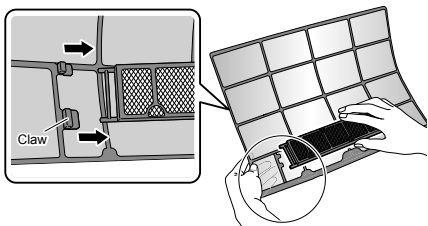

3. Clean or replace the Titanium apatite deodorizing filter.

[Cleaning]

3-1 Vacuum dust, and soak in lukewarm water or water for about 10 to 15 minutes if very dirty.



3-2 After washing, shake off remaining water and let them dry in the shade.

- Do not wring out the filter to remove water from it.

[Replacement]

Remove the filter from the tabs and prepare a new one.



- Dispose of the old filter as non-flammable waste.

4. Insert the Titanium apatite deodorizing filter as they were.

- When attaching the filter, check that the filter is properly set in the tabs.

5. Reattach the filters. ▶Page 34

6. Close the front panel slowly. ▶Page 34

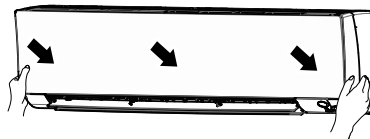

NOTE

- Operation with dirty filters:
 - cannot deodorize the air,
 - cannot clean the air,
 - results in poor heating or cooling,
 - may cause odor.
- Dispose of old filters as non-flammable waste.
- To order a Titanium apatite deodorizing filter, contact the dealer where you bought the unit.

Care and Cleaning

■ Check the units

- Check that the base, stand and other fittings of the outdoor unit are not decayed or corroded.
- Check that nothing blocks the air inlets and the outlets of the indoor unit and the outdoor unit.
- Check that the drain comes smoothly out of the drain hose during COOL or DRY operation.
 - If no drain water is seen, water may be leaking from the indoor unit. Stop operation and consult the service shop if this is the case.

■ Before a long idle period

1. Operate the FAN only for several hours on a fine day to dry out the inside.

- Press **Mode** and select "FAN" operation.
- Press **POWER** and start the operation.

2. After operation stops, turn off the breaker for the room unit.

3. Clean the air filters and set them again.

4. Take out batteries from the remote controller.

■ We recommend periodical maintenance

- In certain operating conditions, the inside of the unit may get foul after several seasons of use, resulting in poor performance. It is recommended to have periodical maintenance by a specialist aside from regular cleaning by the user.
- For specialist maintenance, contact the service shop where you bought the unit.
- The maintenance cost must be born by the user.

Important information regarding the refrigerant used

This product contains fluorinated greenhouse gases. Do not vent gases into the atmosphere.

Refrigerant type: **R32**

GWP ⁽¹⁾ value: **675**

⁽¹⁾ GWP = global warming potential

Periodical inspections for refrigerant leaks may be required depending on European or local legislation. Please contact your local dealer for more information.



NOTICE regarding tCO₂eq

In Europe, the **greenhouse gas emissions** of the total refrigerant charge in the system (expressed as tonnes CO₂-equivalent) is used to determine the maintenance intervals. Follow the applicable legislation.

Formula to calculate the greenhouse gas emissions:

GWP value of the refrigerant × Total refrigerant charge [in kg] / 1000

■ Winter season

- Formed icicles must be removed from the unit.
- Use gloves to avoid injury and damage on the unit.

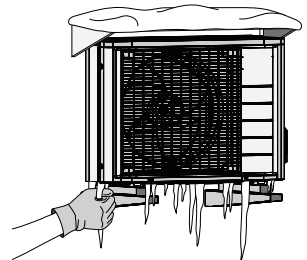

Troubleshooting

■ These cases are not troubles.

- The following cases are not unit troubles but have some reasons. You may just continue using it.

Indoor unit

The flaps do not start swing immediately.

- The unit is adjusting the flaps position. The flaps will start moving soon.

The unit stops generating airflow during operation.

- Once the set temperature is reached, the airflow rate is reduced and operation stopped in order to avoid generating cool airflow (during heating) or in order to keep the humidity from rising (during cooling). Operation will resume automatically when the indoor temperature rises or falls. (For more information see ▶Page 22.)

Operation does not start soon.

- **When "ON/OFF" button was pressed soon after operation was stopped.**
- **When the mode was reselected.**
 - This is to protect the unit.
You should wait for about 3 minutes.

The HEAT operation stops suddenly and a flowing sound is heard.

- The outdoor unit is taking away the frost.
The HEAT operation starts after the frost on the outdoor unit is removed. You should wait for about 4 to 12 minutes.

Outdoor unit

The outdoor unit emits water or steam.

- **In HEAT operation**
 - The frost on the outdoor unit melts into water or steam when the unit is in defrost operation.
- **In COOL or DRY operation**
 - Moisture in the air condenses into water on the cool surface of outdoor unit piping and drips.

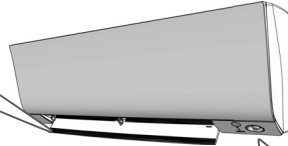

A sound is heard.

■ A sound like a flow of water

- This sound is generated because the refrigerant in the unit is flowing.
- This sound is generated when the water is flowing away from the unit during COOL or DRY operation.

■ Blowing sound

- This sound is generated when the flow of the refrigerant in the unit is switched over.

■ Ticking sound

- This sound is generated when the size of the unit slightly expands or shrinks as a result of temperature changes.

■ Whistling sound

- This sound is generated when refrigerant flows during defrosting operation.

■ Clicking sound during operation or idle time

- This sound is generated when the refrigerant control valves or the electrical parts operate.

■ Clipping sound

- This sound is heard from the inside of the unit when the external device sucks the air out of the room (e.g. exhaust fan, extractor hood) while the doors and windows in the room are closed. Open the doors or window or turn off the device.

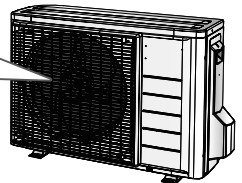

Troubleshooting

- Troubleshooting measures are classified into the following two types on a remedial basis.
Take an appropriate measure according to the symptom.



Not trouble

- These cases are not troubles.



Check

- Please check again before calling a repair person.

The unit does not operate. (OPERATION lamp is off.)

- Hasn't a breaker turned off or a fuse blown?
- Isn't it a power failure?
- Are batteries set in the remote controller?
- Is the timer setting correct? Check if the timer operation lamp is on. [▶Page 23,24](#)



Cooling (Heating) effect is poor.

- Are the air filters clean?
- Is there anything to block the air inlet or the outlet of the indoor and the outdoor units?
- Is the temperature setting appropriate?
- Are the windows and doors closed?
- Are the airflow rate and the airflow direction set appropriately?



An abnormal functioning happens during operation.

- The unit may malfunction with lightning or radio waves. Turn the breaker off, turn it on again and try operating the unit with the remote controller.



Operation stopped suddenly. (OPERATION lamp flashes.)

- Are the air filters clean?
Clean the air filters.
- Is there anything to block the air inlet or the outlet of the indoor and the outdoor units?
- Turn the bleaker off and take all obstacles away. Then turn it on again and try operating the unit with the remote controller. If the lamp still flashes, call the service shop where you bought the unit.



Operation stopped suddenly. (OPERATION lamp is on.)

- For system protection, the unit may stop operating on a sudden large voltage fluctuation. It automatically resumes operation in about 3 minutes.



Mist comes out of the indoor unit.

- This happens when the air in the room is cooled into mist by the cold airflow during COOL operation.
- This is because the air in the room is cooled by the heat exchanger and becomes mist during defrost operation.



Troubleshooting

Hot air does not flow out soon after the start of HEAT operation.

- The unit is warming up. You should wait for 1 to 4 minutes. (The system is designed to start discharging air only after it has reached a certain temperature.)



The ON/OFF TIMER does not operate according to the settings.

- Check if the ON/OFF TIMER and the WEEKLY TIMER are set to the same time. Change or deactivate the settings in the WEEKLY TIMER. ▶Page 25



Remote controller does not work properly.

- Display is flashing.
- No remote controller signals are displayed.
- The remote controller sensitivity is low.
- The display is low in contrast or blacked out.
- The display runs out of control.
- The batteries are dying and the remote controller is malfunctioning. Replace all the batteries with new, size AAA.LR03 (alkaline). For details, refer to set the batteries of this manual. ▶Page 10



The outdoor fan rotates while the unit is not in operation.

- **After operation is stopped**
 - The outdoor fan continues rotating for another 60 seconds for system protection.
- **While the unit is not in operation**
 - When the outdoor temperature is very high, the outdoor fan starts rotating for system protection.



The indoor unit gives out odour.

- This happens when smells of the room, furniture, or cigarettes are absorbed into the unit and discharged with the airflow. (If this happens, we recommend you to have the indoor unit washed by a technician. Consult the service shop where you bought the unit.)



HEAT operation cannot be selected, even though the unit is heat pump model.

- Check that the jumper (J8) has not been cut. If it has been cut, contact the service shop.

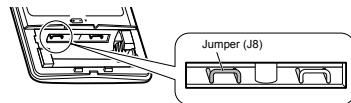

Troubleshooting

■ Call the service shop immediately

WARNING

- **When an abnormality (such as a burning smell) occurs, stop operation and turn the breaker off.**
 - Continued operation in an abnormal condition may result in troubles, electric shocks or fire.
 - Consult the service shop where you bought the unit.
- **Do not attempt to repair or modify the unit by yourself.**
 - Incorrect work may result in electric shocks or fire.
 - Consult the service shop where you bought the unit.

If one of the following symptoms takes place, call the service shop immediately.

- The power cord is abnormally hot or damaged.
- An abnormal sound is heard during operation.
- The safety breaker, a fuse, or the earth leakage breaker cuts off the operation frequently.
- A switch or a button often fails to work properly.
- There is a burning smell.
- Water leaks from the indoor unit.

Turn the breaker off and call the service shop.



■ After a power failure

- The unit automatically resumes operation in about 3 minutes. You should just wait for a while.

■ Lightning

- If lightning may strike the neighbouring area, stop operation and turn the breaker off for system protection.

■ Disposal requirements



Your product and the batteries supplied with the controller are marked with this symbol. This symbol means that electrical and electronic products and batteries shall not be mixed with unsorted household waste.

For batteries, a chemical symbol can be printed beneath the symbol. This chemical symbol means that the battery contains a heavy metal above a certain concentration. Possible chemical symbols are:

- Pb: lead (>0.004%)

Do not try to dismantle the system yourself: the dismantling of the product, treatment of the refrigerant, of oil and of other parts must be done by a qualified installer in accordance with relevant local and national legislation.

Units and waste batteries must be treated at a specialized treatment facility for re-use, recycling and recovery.

By ensuring correct disposal, you will help to prevent potential negative consequences for the environment and human health. Please contact the installer or local authority for more information.

Troubleshooting



■ Fault diagnosis by remote controller

- The remote controller can receive a corresponding error code according to the fault from the indoor unit.

1. When is held down for 5 seconds, a “00” indication blinks on the temperature display section.

2. Press repeatedly until a continuous beep is produced.

- The code indication changes as shown below, and notifies with a long beep.

	CODE	MEANING
SYSTEM	00	NORMAL
	UA	INDOOR-OUTDOOR UNIT COMBINATION FAULT
	U0	REFRIGERANT SHORTAGE
	U2	DROP VOLTAGE OR MAIN CIRCUIT OVERVOLTAGE
	U4	FAILURE OF TRANSMISSION (BETWEEN INDOOR UNIT AND OUTDOOR UNIT)
INDOOR UNIT	A1	INDOOR PCB DEFECTIVENESS
	A5	HIGH PRESSURE CONTROL OR FREEZE-UP PROTECTOR
	A6	FAN MOTOR FAULT
	AH	STREAMER ERROR
	C4	FAULTY HEAT EXCHANGER TEMPERATURE SENSOR
OUTDOOR UNIT	C9	FAULTY SUCTION AIR TEMPERATURE SENSOR
	EA	COOLING-HEATING SWITCHING ERROR
	E1	CIRCUIT BOARD FAULT
	E5	OL STARTED
	E6	FAULTY COMPRESSOR START UP
	E7	DC FAN MOTOR FAULT
	E8	OVERCURRENT INPUT
	F3	HIGH TEMPERATURE DISCHARGE PIPE CONTROL
	F6	HIGH PRESSURE CONTROL (IN COOLING)
	F8	COMPRESSOR INTERNAL TEMPERATURE ERROR
	H0	SENSOR FAULT
	H6	OPERATION HALT DUE TO FAULTY POSITION DETECTION SENSOR
	H8	DC CURRENT SENSOR FAULT
	H9	FAULTY SUCTION AIR TEMPERATURE SENSOR
	J3	FAULTY DISCHARGE PIPE TEMPERATURE SENSOR
	J6	FAULTY HEAT EXCHANGER TEMPERATURE SENSOR
	L3	ELECTRICAL PARTS HEAT FAULT
L4	HIGH TEMPERATURE AT INVERTER CIRCUIT HEATSINK	
L5	OUTPUT OVERCURRENT	
P4	FAULTY INVERTER CIRCUIT HEATSINK TEMPERATURE SENSOR	

NOTE

- A short beep and two consecutive beeps indicate non-corresponding codes.
- To cancel the code display, hold for 5 seconds. The code display also cancel itself if the button is not pressed for 1 minute.

Quick Reference

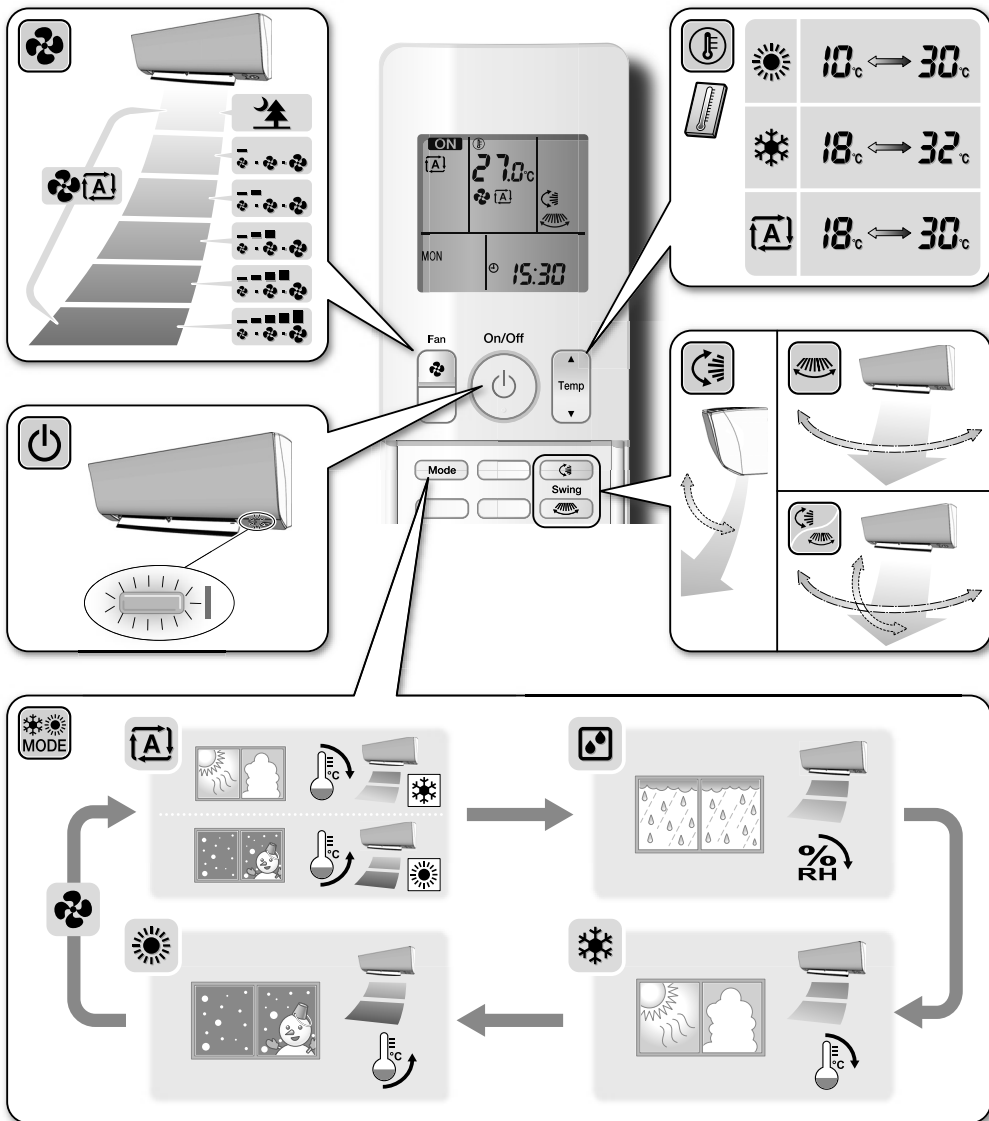

DAIKIN INDUSTRIES CZECH REPUBLIC s.r.o.

U Nové Hospody 1/1155, 301 00 Plzeň Skvrňany, Czech Republic

DAIKIN EUROPE N.V.

Zandvoordestraat 300, B-8400 Oostende, Belgium



3P485919-4H 2018.04