

EN

OWNER'S MANUAL



Split Air Conditioner Alpha Inverter Series



MODELS: CH-S07FTXE
CH-S09FTXE
CH-S12FTXE
CH-S18FTXE
CH-S24FTXE









For proper operation, please read and keep this manual carefully.

Designed by Cooper&Hunter International Corporation, Oregon, USA
www.cooperandhunter.com

CONTENTS

1. IMPORTANT INFORMATIONS.	1
2. COMPONENTS.	2
3. DISPLAY.	2
4. REMOTE CONTROLLER DESCRIPTION.	3
4.1. Description of functions of remote controller buttons.	3
4.2. Name and functions of the display indicators	3
4.3. How to insert the batteries.	4
4.4. How to use the remote control to operate the unit.	4
4.5. Manual operation	6
5. MAINTENANCE.	7
6. OPERATIONS AND PERFORMANCES.	8
7. TROUBLES AND CAUSES.	9
8. INSTALLATION	10
9. TEST OPERATION	16

1. IMPORTANT INFORMATIONS

NORM:	RISK:	
<i>Do not perform operations that involve opening the appliance.</i>	<i>Electrocution from live components. Personal injury from burns due to overheated components or wounds caused by sharp edges or protrusions.</i>	
<i>Do not perform operations that involve removing the appliance from its place of installation.</i>	<i>Electrocution from live components. Personal injury from burns due to cooling gases leaking from disconnected piping.</i>	
<i>Do not start or stop the appliance by simply plugging it into or out of the electricity mains.</i>	<i>Electrocution from a damaged cable or plug or socket.</i>	
<i>Do not damage the power supply cable.</i>	<i>Electrocution from live unsheathed wires.</i>	
<i>Do not leave anything on top of the appliance.</i>	<i>Personal injury from an object falling off the appliance following vibrations.</i>	
<i>Do not climb onto the appliance.</i>	<i>Personal injury due to the appliance falling.</i>	
<i>Do not climb onto chairs, stools, ladders or unstable supports to clean the appliance.</i>	<i>Personal injury from falling from a height or from cuts (stepladders shutting accidentally).</i>	
<i>Do not attempt to clean the appliance without first turning it off and unplugging it or switching the dedicated switch off.</i>	<i>Electrocution from live components.</i>	
<i>Do not allow children or inexperienced people to use the appliance.</i>	<i>Damage to the appliance due to improper use.</i>	
<i>Do not direct the air flow towards gas hobs or gas stoves.</i>	<i>Explosions, fires or intoxication from the discharge of gas leaking from the burner nozzle once the air flow has put the flame out.</i>	
<i>Do not place your fingers in the air outlets or in the air inlet grilles.</i>	<i>Electrocution from live components. Personal injury from cuts.</i>	
<i>Do not drink the condensation water.</i>	<i>Personal injury from poisoning.</i>	
<i>Should the smell of burning be detected or smoke exit the appliance, disconnect it from the electricity supply, open all windows and call in the technician.</i>	<i>Personal injury from burns or smoke inhalation.</i>	
<i>Do not perform operations that involve removing the appliance from its place of installation.</i>	<i>Flooding due to water leaking from disconnected piping.</i>	
<i>Do not leave anything on top of the appliance.</i>	<i>Damage to the appliance or any objects underneath it due to the appliance falling off from its place of installation.</i>	
<i>Do not use any insecticides, solvents or aggressive detergents to clean the appliance.</i>	<i>Damage to the plastic and painted parts.</i>	
<i>Do not use the appliance for any use other than normal domestic use.</i>	<i>Damage to the appliance due to operation overload. Damage to objects treated inappropriately.</i>	
<i>Do not allow children or inexperienced people to use the appliance.</i>	<i>Damage to the appliance due to improper use.</i>	
<i>Do not direct the air flow towards valuable articles, plants or animals.</i>	<i>Damage or perishing due to excessive cold/heat, humidity, ventilation.</i>	
<i>Do not use the air conditioning unit for extended periods of time in conditions of more than 80% humidity.</i>	<i>Damage to objects due to excessive dripping of condensation from the appliance.</i>	

2. COMPONENTS

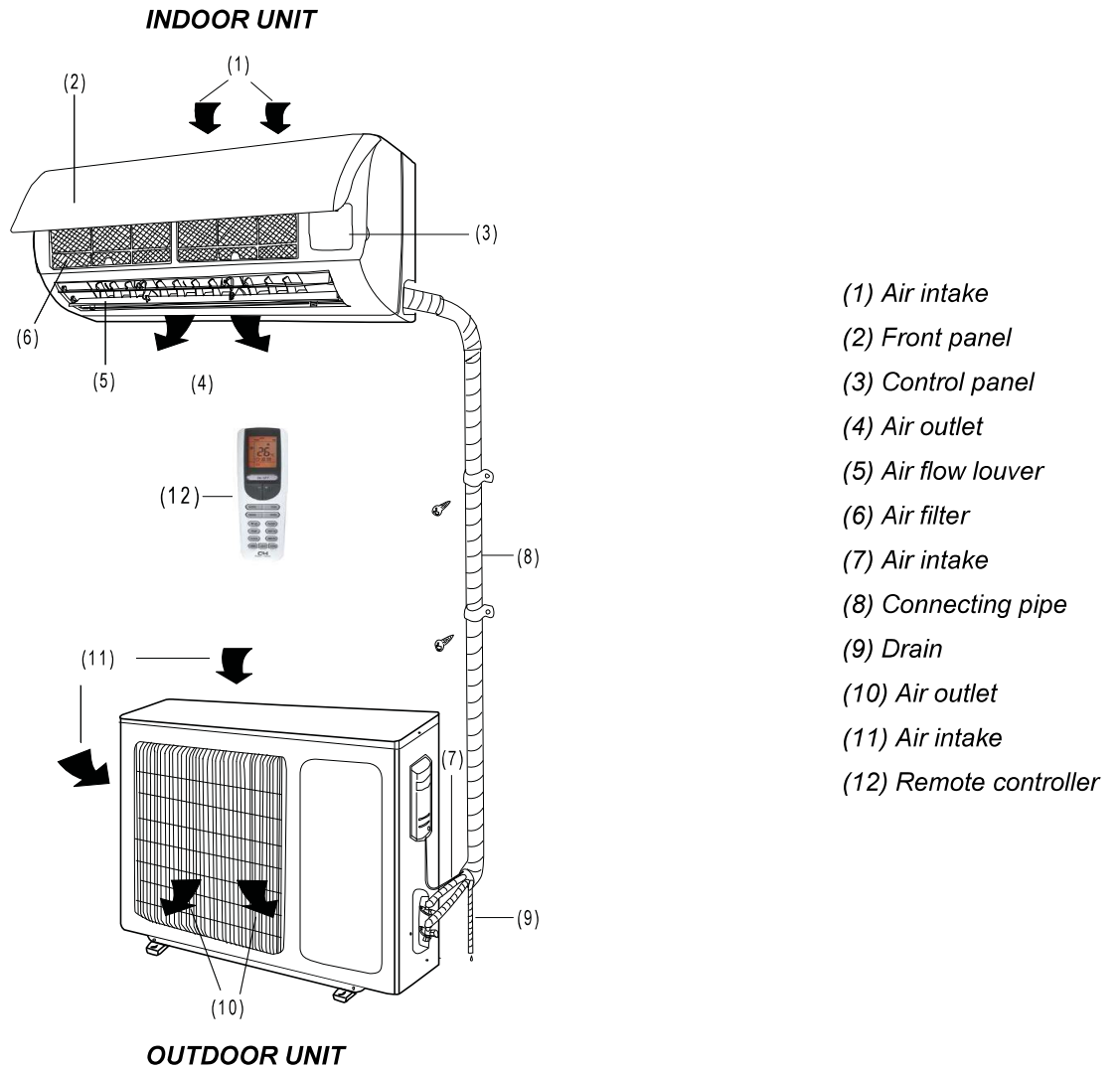

3. DISPLAY

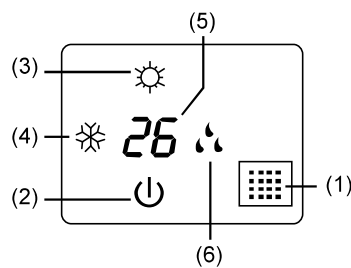

(1) LED signal receiver

(2) Operation indicator

This indicator flashes after power is on and illuminates when the unit is in operation.

(3) Heating indicator

This indicator illuminates during the operation in heating mode.

(4) Cooling indicator

This indicator illuminates during the operation in cooling mode.

(5) Setting temperature indicator





It displays the setting temperature during the operation of the air conditioner.

(6) Dehumidification indicator

It illuminates during the operation in dehumidification mode.

4. REMOTE CONTROLLER DESCRIPTION







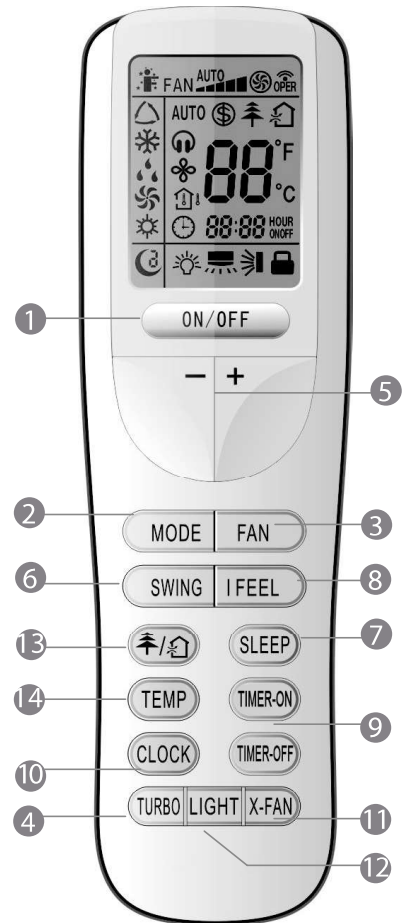











4.1. Description of functions of remote controller buttons

- ①  button to turn the air conditioner on and off.
 - ② **MODE** button to select the operating mode: AUTO "🏠", COOL "❄️", DRY "💧", FAN "🌀", HEAT "☀️".
 - ③ **FAN** button to set the fan speed in the sequence that goes from Auto, Low (▴), Low-Medium speed (▴▴), Medium speed (▴▴▴), Medium-High speed (▴▴▴▴), High speed (▴▴▴▴▴).
- 
- ④ **TURBO** button used to enable/disable the rapid cooling or heating mode.
 - ⑤ **ADJUSTING** "▲"/"▼" buttons to adjust ambient temperature and the timer: "▲" increasing, "▼" decreasing.
 - ⑥  button used to set up and down swing angle.
 - ⑦ **SLEEP** button to set/cancel the Sleep mode regardless of the operating mode of the conditioner.
 - ⑧ **IFEEL** button to enable/disable the **IFEEL** mode.
 - ⑨ **TIMER ON / TIMER OFF** selection buttons. Used to set auto-off/auto-on timer.
 - ⑩ **CLOCK** button is used to set the current time.
 - ⑪ **X-FAN** button press it to begin/stop indoor fan which is used to dry the components
 - ⑫ **LIGHT** button used to turn on or off the unit's display.
 - ⑬  button to set HEALTH/AIR function for air cleaning / for air change (🏠 not available).
 - ⑭ **TEMP** button, press it to show the set point temperature on the unit's display.

REMOTE CONTROLLER





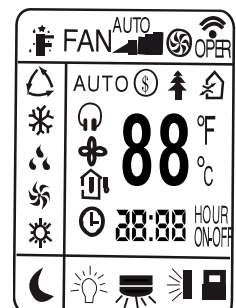

4.2. Name and functions of the display indicators

-  : **AUTO** mode indicator
-  : **COOL** mode indicator
-  : **DRY** mode indicator
-  : **FAN** mode indicator
-  : **HEAT** mode indicator
-  : **SLEEP** mode indicator
-  : **CLOCK** indicator
-  : **TIMER ON-OFF** mode indicator
-  : **TEMP** indicator
-  : **FAN** mode indicator
-  : **AIR CLEANER** mode indicator
-  : **QUIET** mode indicator (not available).
-  : 8°C Heating function indicator
-  : **AIR RENEWING** mode indicator (not available)
-  : **LIGHT** mode indicator
-  : **LOCK** indicator
-  : Up and down air deflector indicator
-  : Left and right air deflector indicator (not available).
-  : **TURBO** mode indicator

DISPLAY



-  OPER : Signal sent confirmation LED
-  IFEEL : IFEEL mode indicator
-  FAN ^{AUTO} : Fan Speed indicator
-  88 ^{°C} / ^{°F} : Temperature display indicator

4.3. How to insert the batteries

Use two new alkaline type batteries with AAA 1,5V.

- ① Slide down the cover of the battery compartment.
- ② and ③ Remove the used batteries and insert new ones correctly.
- ④ Reattach the cover by sliding it back into its position.

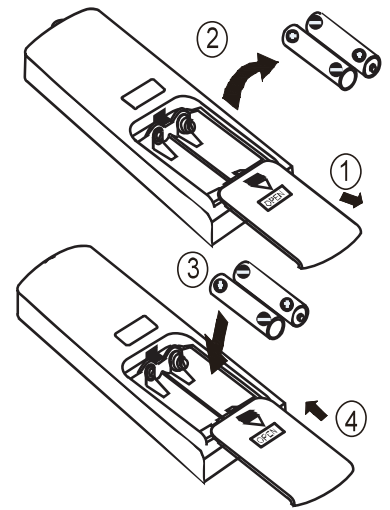

Notes

- ◆ Do not use old batteries or different type batteries. Such a use may cause remote control wrong functioning.
- ◆ If you do not use the remote control more than two weeks, remove the batteries. Damages may be caused by possible leakages.
- ◆ Replace batteries when no "beep" is received from the indoor unit or if the transmission indicator on the remote controller fails to light.

4.4. How to use the remote control to operate the unit





● SWITCHING THE UNIT ON AND OFF



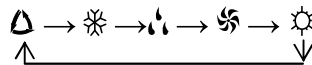

Press the  button to switch the unit on or off.

● SETTING THE OPERATING MODE

By pressing the Mode button several times it is possible to change the unit operating mode. The selected operating mode symbol appears on the display.



-  : automatic mode
-  : cooling mode
-  : dehumidification mode
-  : fan only mode
-  : heating mode

When the automatic programme AUTO is selected, the unit may operate in COOLING or HEATING mode depending on the temperature difference in place between the ambient temperature and the temperature selected on the remote control. When the cooling mode  is selected, the unit operates with a free temperature setting, lowering the ambient temperature. When the dehumidification mode  is selected, the unit operates with a free temperature setting, progressively lowering the ambient temperature and humidity. When the dehumidification mode is in operation, the FAN button cannot be used. When the heating mode  is selected, the unit operates with a free temperature setting, raising the ambient temperature. When the fan mode  is selected, the unit operates without temperature settings, simply blowing air through the environment.





	<p>IMPORTANT!</p> <ul style="list-style-type: none"> ◆ The unit fan stops when the set temperature is reached and is then automatically reactivated at minimum speed to prevent air stratification phenomena in the vicinity of the appliance. ◆ When the COOLING, DEHUMIDIFICATION mode is selected, the fan may not start up straight away because the ANTI-HEATING mode is present. When the HEATING mode is selected, the fan may not start up straight away because the ANTI-COOLING mode is present.
---	---

● SETTING THE LOUVERS

In order to obtain optimal air distribution, adjust the motorised louvers, making sure that the air flow is not directly pointed at anyone. For the motorised louvers, proceed as follows:

1) Press the button  to set swing up and down angle, which circularly changes as below:

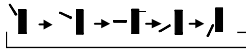

Note: This remoter is universal. If any command ,  or  is sent out, the unit will carry out the command as .

 indicates the guide louver swings as: 





2) Press the button  to set left and right swig angle, which circularly changes as below (not available):



● SETTING THE FAN

By pressing the FAN button several times it is possible to adjust the fan speed between the three available speeds, or to activate the AUTO mode. The operating mode appears on the display:







Auto, Low () , Low-Medium speed () , Medium speed () , Medium-High speed () , High speed () .

● IFEEL FUNCTION SETTING

Press this button to turn on IFEEL function. The unit automatically adjusts temperature according to the sensed temperature. Press this button again to cancel IFEEL function.

● FUNCTION (the function of air renewing is not available)

Press this button to achieve the on and off of healthy and scavenging functions in operation status. Press this button for the first time to start scavenging function; LCD displays "". Press the button for the second time to start healthy and scavenging functions simultaneously; LCD displays "" and "". Press this button for the third time to quit healthy and scavenging functions simultaneously. Press the button for the fourth time to start healthy function; LCD display "". Press this button again to repeat the operation above.

● SLEEP MODE SETTING

SLEEP mode can be set in COOLING or HEATING operation mode. This function gives you a more comfortable environment for sleep.

In SLEEP mode,

◆ Fan speed is automatically set at low speed.

◆ Press the "SLEEP" button to set the unit to the sleep mode. The SLEEP indicator will light up on the display. The temperature increases/decrease in cooling/heating mode operation by 1°C at set intervals. After reaching 2°C the unit maintains this temperature through to the eighth hour (8 hours) of operation in the "SLEEP" mode and then switches off automatically.

● TEMP FUNCTION

Press **TEMP** button to show the set point temperature, indoor ambient temperature and outdoor ambient temperature on the unit's display.

Note: Outdoor ambient temperature is only displayed for some models.

● CLOCK SETTING

To adjust the real time press **CLOCK** button, then use "**▲**" and "**▼**" buttons to get the correct time.

◆ Press the button "**▲**" / "**▼**" once to increase/decrease the time setting by 1 minute.

◆ Press the button "**▲**" / "**▼**" for 2 seconds to increase/decrease the time setting by 10 minutes.

◆ Press **CLOCK** button again the real time is set.

● TIMER MODE SETTING

Push the buttons **TIMER** to set the timer programming as wished in order to switch on and off the air conditioner at the desired time.

- How to set **TIMER ON**

TIMER ON button can be used to set the timer programming as wished in order to switch on the appliance at your desired time.

1) Press **TIMER ON** button, "ON" flashes on the LCD, then you can press the "**▲**" or "**▼**" buttons to select your desired

time for appliance on.

◆ Press the "▲" / "▼" button once to increase or decrease the time setting by 1 minute.

◆ Press the button "▲" / "▼" for 2 seconds to increase/decrease the time setting by 10 minutes.

Note: If you don't set the time in 10 seconds after you press TIMER ON button, the remote controller will exit the TIMER ON mode automatically.

2) When your desired time displayed on LCD, press the TIMER ON button and confirm it, a beep can be heard and then the TIMER indicator "ON" the indoor unit stops flashing.

3) After the set timer displayed, the clock will be displayed on the LCD of the remote controller instead of set timer.

- How to cancel TIMER ON

Press the TIMER ON button again, a "beep" can be heard and the indicator disappears, the TIMER ON mode has been cancelled.

Note: It is similar to set TIMER OFF; you can make the appliance switch off automatically at your desired time.

● TURBO MODE SETTING:

◆ TURBO mode is used to start or stop fast cooling and heating at high fan speed.

◆ In Turbo mode, you can set airflow direction or timer. If you want to exit from TURBO mode, press any - TURBO, MODE, FAN or ⏻ button, the display will return to the original mode.

● LIGHT FUNCTION

Press LIGHT button to turn on the display's light and press this button again to turn off the display's light. If the light is turned on, is displayed. If the light is turned off, 💡 disappears.

● X-FAN FUNCTION

Pressing X-FAN button in COOL or DRY mode, the icon ⚙️ is displayed and the indoor fan will continue operation for 10 minutes in order to dry the indoor unit even though you have turned off the unit.

After electrification, X-FAN OFF is defaulted. X-FAN is not available in AUTO, FAN or HEAT mode.

● LOCK FUNCTION 🗝️

Press the "▲" and "▼" buttons at the same time to block the last setting operation by the remote controller.

All the buttons disabled, including the ⏻ button. Press the "▲" and "▼" buttons again to enable the buttons functions.

● °C / °F FUNCTION

Press the "MODE" and "▼" buttons at the same time with the unit off to choose the display of temperature in °C and °F.

● ENERGY-SAVING FUNCTION

Press "TEMP" and "CLOCK" simultaneously in COOL mode to start energy-saving function.

Nixie tube on the remote controller displays "SE". Repeat the operation to quit the function.

● 8°C HEATING FUNCTION

Press "TEMP" and "CLOCK" simultaneously in HEAT mode to start 8°C Heating Function Nixie tube on the remote controller displays Ⓢ and a selected temperature of "8°C".

(46 if Fahrenheit is adopted). Repeat the operation to quit the function.

4.5. Manual operation

Manual operation can be used temporarily in case you cannot find the remote controller or its batteries are exhausted.

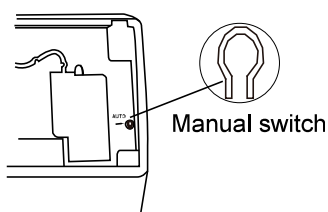

1. Open and lift the front panel up to an angle until it remains fixed with a clicking sound.
2. One press of the manual control button will lead to the forced AUTO operation.
3. Close the panel firmly to its original position.

CAUTION:

- Once you push the manual button, the operation mode will be selected according to the room temperature as: COOL, HEAT, FAN.
- Press the button to stop the operation of the air conditioner.

5. MAINTENANCE

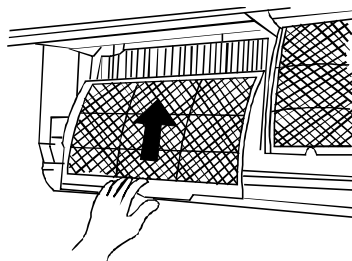
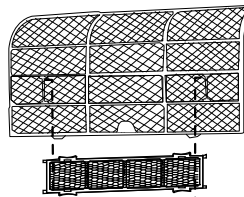
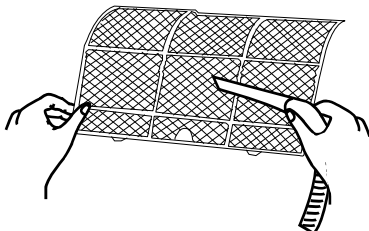
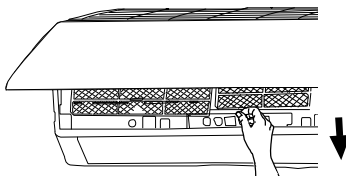
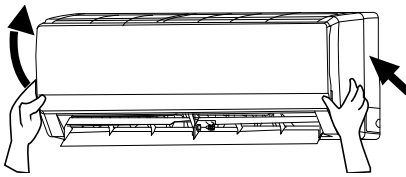
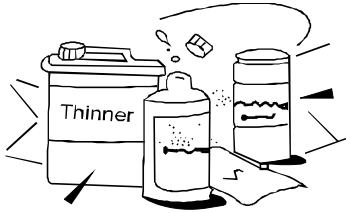

WARNING

It is necessary to stop the air conditioner and disconnect the power supply before cleaning.

Cleaning the indoor unit and remote controller

CAUTIONS

- Use a dry cloth to wipe the indoor unit and remote controller.
- A cloth dampened with cold water may be used on the indoor unit if it is very dirty.
- The front panel of the indoor unit can be removed and cleaned with water. Then wipe it with a dry cloth.
- Do not use a chemically treated cloth or duster to clean the unit.
- Do not use benzene, thinner, polishing powder, or similar solvents for cleaning. These may cause the plastic surface to crack or deform.

Cleaning the air filter

A clogged air filter reduces the cooling efficiency of this unit. Please clean the filter once every 2 weeks.

1. Lift the indoor unit panel up to an angle until it stops with a clicking sound.
2. Take hold of the handle of the air filter and lift it up slightly to take it out from the filter holder, and then pull it downwards.
3. Remove the AIR FILTER from the indoor unit.

- Clean the AIR FILTER once two weeks.

- Clean the AIR FILTER with a vacuum cleaner or water, and then dry it up cool place.

4. Remove the healthy filter from its support frame as shown in the Figure on the left (Not applicable to the units without electrostatic filter).

Do not touch this Electrostatic Filter within 10 minutes after opening the inlet grille; it may cause an electric shock.

- Clean the electrostatic filter with mild detergent or water and dry in the sunlight for two hours.
 - Before re-install the Electrostatic Filter, check whether the corona line or support frame is damaged or not.
5. Install the air freshening filter back into position.
 6. Insert the upper portion of air filter back into the unit taking care that the left and right edges line up correctly and place filter into position.

Maintenance

If you plan to idle the unit for a long time, perform the following:

- (1) Operate the fan for about half a day to dry the inside of the unit.
- (2) Stop the air conditioner and disconnect power. Remove the batteries from the remote controller.
- (3) The outdoor unit requires periodic maintenance and cleaning. Do not attempt to do this yourself. Contact your dealer or servicer.

Checks before operation

- Check that the wiring is not broken off or disconnected.
- Check that the air filter is installed.
- Check if the air outlet or inlet is blocked after the air conditioner has not been used for a long time.

CAUTIONS

- Do not touch the metal parts of the unit when removing the filter. Injuries can occur when handling sharp metal edges.

- Do not use water to clean inside the air conditioner. Exposure to water can destroy the insulation, leading to possible electric shock.
- When cleaning the unit, first make sure that the power and circuit breaker are turned off.

6. OPERATIONS AND PERFORMANCES

The following events may occur during normal operation.

1. Protection of the air conditioner.

Compressor protection

- The compressor can't restart for 3 minutes after it stops.

Anti-cold air (Cooling and heating models only)

- The unit is designed not to blow cold air on HEAT mode, when the indoor heat exchanger is in one of the following three situations and the set temperature has not been reached.

A) When heating has just starting.

B) Defrosting.

C) Low temperature heating.

- The indoor or outdoor fan stop running when defrosting (Cooling and heating models only). Defrosting (Cooling and heating models only)
- Frost may be generated on the outdoor unit during heat cycle when outdoor temperature is low and humidity is high resulting in lower heating efficiency of the air conditioner.
- During this condition air conditioner will stop heating operation and start defrosting automatically.
- The time to defrost may vary from 4 to 10 minutes according to the outdoor temperature and the amount of frost build-up on the outdoor unit.

2. A white mist coming out from the indoor unit

- A white mist may generate due to a large temperature difference between air inlet and air outlet on COOL mode in an indoor environment that has a high relative humidity.
- A white mist may generate due to moisture generated from defrosting process when the air conditioner restarts in HEAT mode operation after defrosting.

3. Low noise of the air conditioner

- You may hear a low hissing sound when the compressor is running or has just stopped running. This sound is the sound of the refrigerant flowing or coming to a stop.
- You can also hear a low "squeak" sound when the compressor is running or has just stopped running. This is caused by heat expansion and cold contraction of the plastic parts in the unit when the temperature is changing.
- A noise may be heard due to louver restoring to its original position when power is first turned on.

4. Dust is blown out from the indoor unit.

This is a normal condition when the air conditioner has not been used for a long time or during first use of the unit.

5. A peculiar smell comes out from the indoor unit.

This is caused by the indoor unit giving off smells permeated from building material, from furniture, or smoke.

6. The air conditioner turns to FAN only mode from COOL or HEAT (For cooling and heating models only) mode.

When indoor temperature reaches the temperature setting on air conditioner, the compressor will stop automatically, and the air conditioner turns to FAN only mode. The compressor will start again when the indoor temperature rises on COOL mode or falls on HEAT mode (For cooling and heating models only) to the set point.

7. Dripping water may generate on the surface of the indoor unit when cooling in a high relatively humidity (relative humidity higher than 80%).

Adjust the horizontal louver to the maximum air outlet position and select HIGH fan speed.

8. Heating mode (For cooling and heating models only)

The air conditioner draws in heat from the outdoor unit and releases it via the indoor unit during heating operation. When the outdoor temperature falls, heat drawn in by the air conditioner decreases accordingly. At the same time, heat loading of the air conditioner increases due to larger difference between indoor and outdoor temperature. If a comfortable temperature can't be achieved by the air conditioner, we suggest you use a supplementary heating device.

9. Auto-restart function

Power failure during operation will stop the unit completely.

For the unit without Auto-restart feature, when the power restores, the OPERATION indicator on the indoor unit starts flashing. To restart the operation, push the  button on the remote controller. For the unit with Auto-restart feature, when the power restores, the unit restarts automatically with all the previous settings preserved by the memory function.

10. Lightning or a car wireless telephone operating nearby may cause the unit to malfunction.

Disconnect the unit with power and then re-connect the unit with power again. Push the  button on the remote controller to restart operation.

7. TROUBLES AND CAUSES

Stop the air conditioner immediately if one of the following faults occur. Disconnect the power and contact the nearest customer service center.

Trouble	<i>OPERATION indicator or other indicators flash rapidly (5 times every second) and this flash cannot be fixed by disconnecting the power, and then connect it again</i>
	<i>Fuse blows frequently or circuit breaker trips frequently</i>
	<i>Other objects or water penetrate the air conditioner</i>
	<i>The remote controller won't work or works abnormally</i>
	<i>Other abnormal situations</i>

Malfunctions	Cause	What should be done?
<i>Unit does not start</i>	<i>Power cut</i>	<i>Wait for power to be restored</i>
	<i>Unit may have become unplugged.</i>	<i>Check that plug is securely in wall receptable</i>
	<i>Fuse may have blown.</i>	<i>Replace the fuse</i>
	<i>Battery in remote controller may have been exhausted.</i>	<i>Replace the battery</i>
	<i>The time you have set with timer is incorrect.</i>	<i>Wait or cancel timer setting</i>
<i>Unit not cooling or heating room very well while air flowing out from the air conditioner</i>	<i>Inappropriate temperature setting</i>	<i>Set temperature correctly</i>
	<i>Air filter is blocked</i>	<i>Clean the air filter</i>
	<i>Doors or Windows are open</i>	<i>Close the doors or windows</i>
	<i>Air inlet or outlet of indoor or outdoor unit has been blocked</i>	<i>Clear obstructions away first, then restart the unit</i>
	<i>Compressor 3 minutes protection has been achieved</i>	<i>Wait</i>

If the trouble has not been corrected, please contact a local dealer or the nearest customer service center. Be sure to inform them of the detailed malfunctions and unit model.

Notes: Do not attempt to repair the unit yourself. Always consult an authorised service provider.

8. INSTALLATION

Indoor unit

- Do not expose the indoor unit to heat or steam.
- Select a place where there are no obstacles in front or around the unit.
- Make sure that condensation drainage can be conveniently routed away.
- Do not install near a doorway.
- Ensure that the space on the left and right of the unit is more than 12 cm.
- Use a stud finder to locate studs to prevent unnecessary damage to the wall.
- A minimum pipe run of 3 metres is required to minimise vibration & excessive noise.
- The indoor unit should be installed on the wall at a height of 2.3 metres or more from the floor.
- The indoor unit should be installed allowing a minimum clearance of 15cm from the ceiling.
- Any variations in pipe length will/may require adjustment to refrigerant charge.

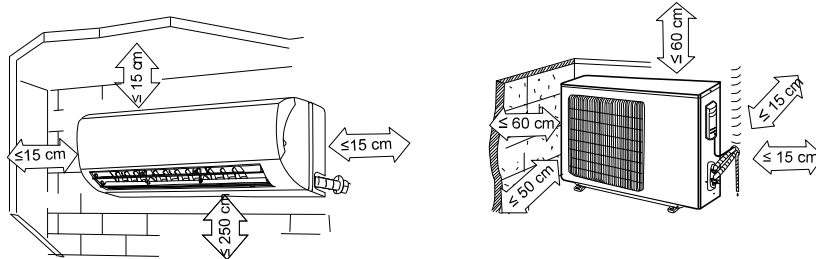

Outdoor unit

If an awning is built over the outdoor unit to prevent direct sunlight or rain exposure, make sure that heat radiation from the condenser is not restricted.

- Ensure that the clearance around the back of the unit is more than 30 cm and left side is more than 30 cm. The front of the unit should have more than 200 cm of clearance and the connection side (right side) should have more than 60 cm of clearance. Do not place animals and plants in the path of the air inlet or outlet.
- Take the air conditioner weight into account and select a place where noise and vibration will not be an issue.
- Select a place so that the warm air and noise from the air conditioner do not disturb neighbours.
- Install the outdoor unit on a rigid base to prevent increasing noise level and vibration.
- Determine the air outlet direction where the discharged air is not blocked.
- In the case that the installation place is exposed to strong wind such as a seaside, make sure the fan operating properly by putting the unit lengthwise along the wall or using a dust or shield plates.
- Specially in windy area, install the unit to prevent the admission of wind.
- If need suspending installation, the installation bracket should accord with technique requirement in the installation bracket diagram. The installation wall should be solid brick, concrete or the same intensity construction, or actions to reinforce, damping supporting should be taken. The connection between bracket and wall, bracket and the air conditioner should be firm, stable and reliable.
- Be sure there is no obstacles which block radiating air.

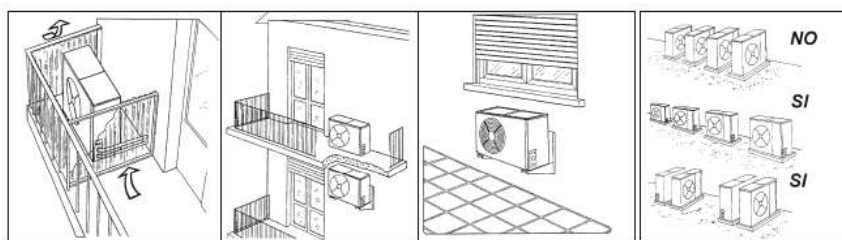

Rooftop installation:

- If the outdoor unit is installed on a roof structure, be sure to level the unit. Ensure the structure and anchoring method are adequate for the unit location.
- Consult local codes regarding rooftop mounting.
- If the outdoor unit is installed on roof structures or external walls, this may result in excessive noise and vibration, and may also be classed as a non-serviceable installation.

1. Fit the installation Plate

1. Fit the installation plate horizontally on structural parts of the wall with spaces around the installation plate.
2. If the wall is made of brick, concrete or the like, drill 5 holes in the wall of 5 mm diameter. Insert Clip anchor for appropriate mounting screws.
3. Fit the installation plate on the wall with type "ST4.2X25TA" screws. Fit the Installation Plate and drill holes in the wall according to the wall structure and corresponding mounting points on the installation plate. (Dimensions are in "mm" unless otherwise stated).

Mod. 2600 W, 3500 W

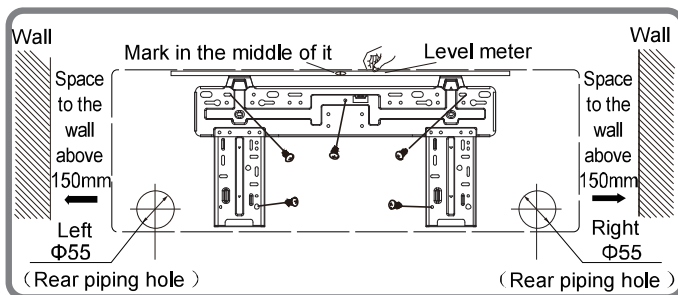

Mod. 5300 W

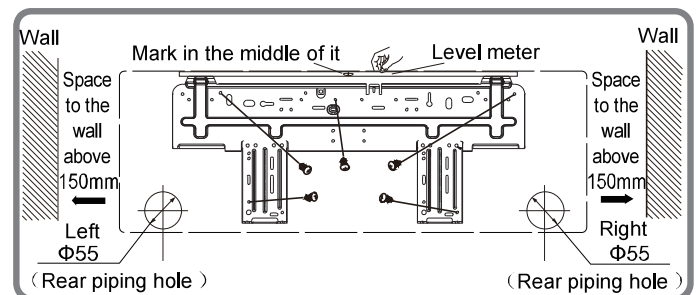

Mod. 7000 W

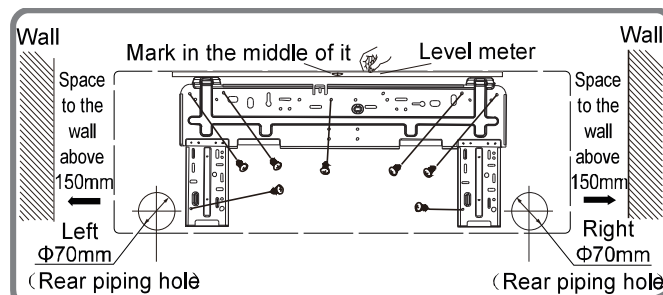

Drill a hole in the wall

1. Determine hole positions according to the diagram detailed in the figure above. Drill one (1) hole (the diameter is indicated in the installation plate) slanting slightly to outdoor side.
2. Always use wall hole conduit when drilling metal plate or the like.

Connective Pipe and Drainage Installation

1. Run the drain hose sloping downward. Do not install the drain hose as illustrated below.
2. When connecting extension drain hose, insulate the connecting part of extension drain hose with a shield pipe, do not let the drain hose slack.

Connective pipe

1. For the left-hand and right-hand piping, remove the pipe cover from the side panel.
 - Explain to clients that the pipe cover must be kept as it may be used when relocate the air conditioner to any other place.
2. For the rear-right-hand and rear-left-hand piping, install the piping as shown. Bend the connective pipe to be laid at 43mm height or less from the wall.
3. Fix the end of the connective pipe. (Refer to Tightening Connection in REFRIGERANT PIPING CONNECTION).

Indoor unit installation

1. Pass the piping through the hole in the wall.
2. Put the upper claw at the back of the indoor unit on the upper hook of the installation plate, move the indoor unit from side to side to see that it is securely hooked.
3. Piping can easily be made by lifting the indoor unit with a cushioning material between the indoor unit and the wall. Get it out after piping.
4. Push the lower part of the indoor unit up on the wall. Then move the indoor unit from side to side, up and down to check if it is hooked securely.

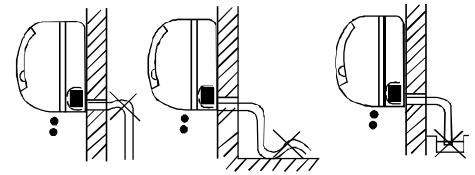

Settlement of outdoor unit

Anchor the outdoor unit with a bolt and nut 10 or 8 tightly and horizontally on a concrete or rigid mount.

Drain joint installation

Fit the seal into the drain elbow, then insert the drain joint into the base pan hole of outdoor unit, rotate 90 to securely assemble them. Connecting the drain joint with an extension drain hose (Locally purchased), in case of the water draining off the outdoor unit during the heating mode.

Piping and wrapping

Bundle the tubing, connecting cable, and drain hose with tape securely.

- Because the condensed water from rear of the indoor unit is gathered in pending box and is piped out of room. Do not put anything else in the box.

CAUTION

- Connect the indoor unit first, then the outdoor unit.
- Do not allow the piping to let out from the back of the indoor unit.
- Be careful not to let the drain hose slack.
- Heat insulated both of the auxiliary piping.
- Be sure that the drain hose is located at the lowest side of the bundle. Locating at the upper side can cause drain pan to over flow inside the unit.
- Never intercross nor intertwist the power wire with any other wiring.
- Run the drain hose sloped downward to drain out the condensed water smoothly.
- The power cables should not come into contact with the tubing.

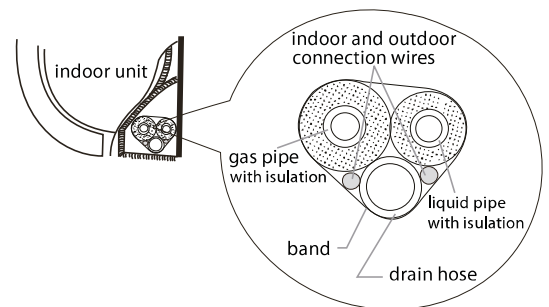

Models 1 x 1 DC INV.	Connective pipe length max without additional refrigerant (m)	Allowed connective pipe length (m)	Max. difference in level (m)	Additional amount of refrigerant (g/m)	Φliquid/Φgas
2600 W	5	15	10	20	Φ6,35/Φ9,52
3500 W	5	20	10	20	Φ6,35/Φ9,52
5300 W	5	25	10	20	Φ6,35/Φ12,7
7000 W	5	25	10	50	Φ6,35/Φ16

Wiring connections

Connect the cable to the indoor unit

1. Indoor/Outdoor connection cable should be H07RN-F type.
2. Lift the indoor unit panel up and remove the screw, then remove the window cover
3. Connect cables according to their marks to terminals.
4. Wrap those cables not connected with terminals with insulation tapes, so that they will not touch any electrical components.

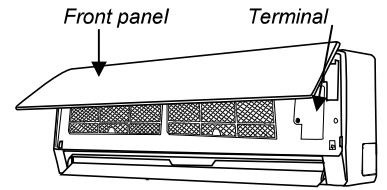

Indoor unit

Access door terminal

Connect the cable to the outdoor unit

1. Remove the electric parts cover from the outdoor unit.
2. Connect the connective cables to the terminals as identified with their respective matched numbers on the terminal block of indoor and outdoor units.
2. Power supply connection cable should be H07RN-F.
3. To prevent the ingress of water, from a loop of the connective cable as illustrated in the installation diagram of indoor and outdoor units.
4. Insulate unused cords (conductors) with PVC-tape. Process them so they do not touch any electrical or metal parts.

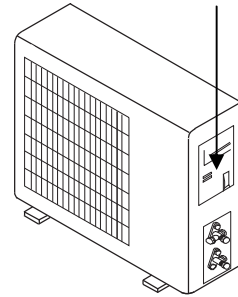

Outdoor unit

Wires specifications

Model (W)	Power connecting cable	Indoor - outdoor connecting cable	Main power supply	Air switch capacity (A)
	Section	Section		
2600 W, 3500 W	3 x 1.5 mm ²	4 x 0,75 mm ²	To outdoor	20 A (240V)
5300 W, 7000 W	3 x 1.5 mm ²	4 x 0,75 mm ²	To outdoor	25 A (240V)

Wiring diagrams

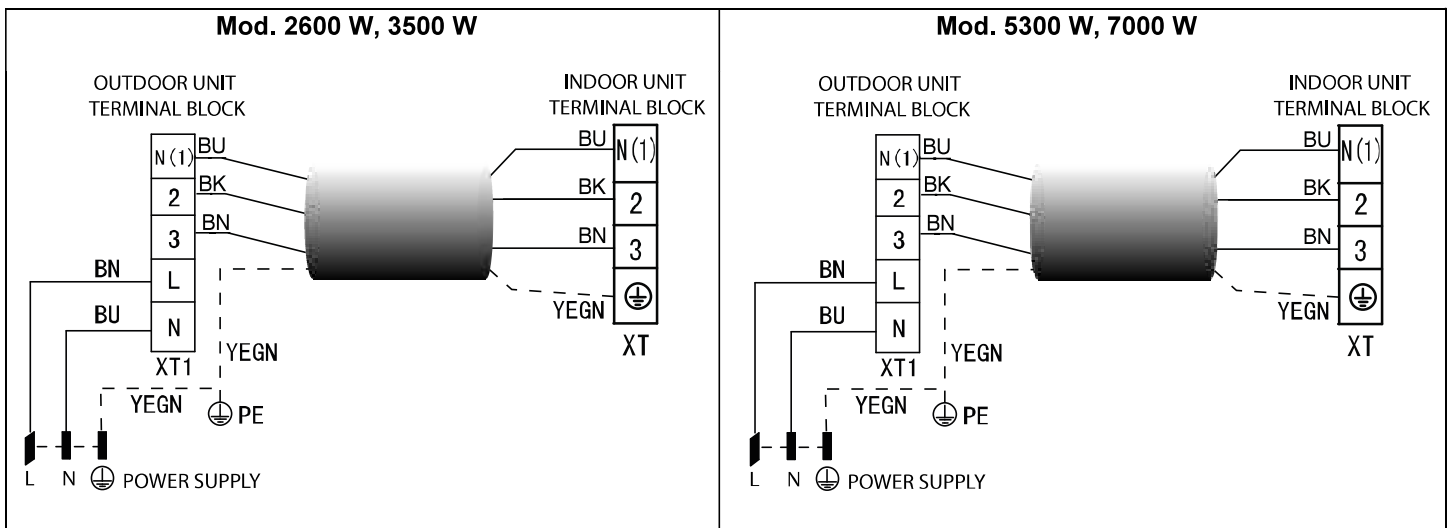

Refrigerant piping connection

1. Flaring work

Main cause for refrigerant leakage is due to defect in the flaring work. Carry out correct flaring work using the following procedure:

A: Cut the pipes and the cable.

1. Use the piping kit accessory or pipes purchased locally.
2. Measure the distance between the indoor and the outdoor unit.
3. Cut the pipes a little longer than the measured distance.
4. Cut the cable 1.5m longer than the pipe length.

B: Burr removal

1. Completely remove all burrs from the cut cross section of pipe/tube.
2. Put the end of the copper tube/pipe in a downward direction as you remove burrs in order to avoid dropping burrs into the tubing.

C: Putting nut on

Remove flare nuts attached to indoor and outdoor unit, and then put them on pipe/tube having completed burr removal. (Not possible to put them on after flaring work).

D: Flaring work

Firmly hold copper pipe in a die in the dimension shown in the table below.

Outer diam. (mm)	A (mm)	
	Max.	Min
Φ 6,35	1,3	0,7
Φ 9,52	1,6	1
Φ 12,7	1,8	1
Φ 16	2	1

Tightening Connection

- Align the center of the pipes.
- Sufficiently tighten the flare nut with fingers, and then tighten it with a spanner and torque wrench as shown.

CAUTION:

- Excessive torque can break nut depending on installation conditions.

Hex nut diam. (mm)	Tightening torque (N.m)
Φ 6,35	15 ~ 20
Φ 9,52	31 ~ 35
Φ 12,7	50 ~ 55
Φ 16	60 ~ 65

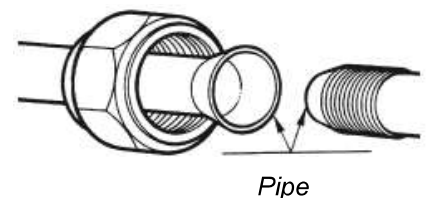
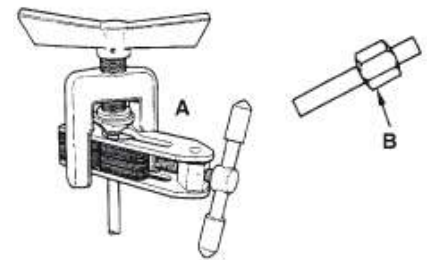
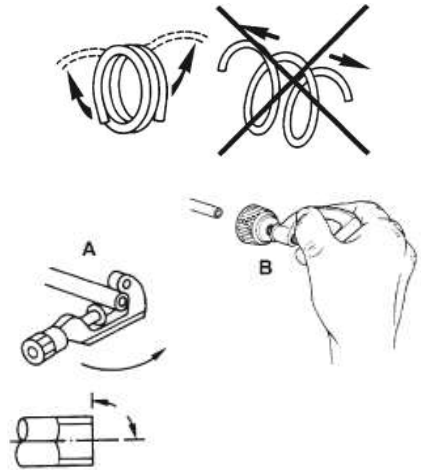

Air purging

Air and moisture in the refrigerant system have undesirable effects as indicated below:

- Pressure in the system rises.
- Operating current rises.
- Cooling or heating efficiency drops.
- Moisture in the refrigerant circuit may freeze and block capillary tubing.
- Water may lead to corrosion of parts in the refrigeration system.

Therefore, the indoor unit and tubing between the indoor and outdoor unit must be leak tested and evacuated to remove any non-condensable and moisture from the system.

Air purging with vacuum pump

Preparation

Check that each tube (both liquid and gas side tubes) between the indoor and outdoor units have been properly connected and all wiring for the test run has been completed. Remove the service valve caps from both the gas and the liquid side on the outdoor unit.

Note that both the liquid and the gas side service valves on the outdoor unit are kept closed at this stage.

- Pipe length and refrigerant amount:
- When relocate the unit to another place, perform evacuation using vacuum pump.

Make sure the refrigerant added into the air conditioner is liquid form in any case.

Caution in handling the packed valve

- Open the valve stem until it hits against the stopper. Do not try to open it further.
- Securely tighten the valve stem cap with a spanner or the like.
- Valve stem cap tightening torque (See Tightening torque table in previous page).

When Using the Vacuum Pump

(For method of using a manifold valve, refer to its operation manual.)

1. Completely tighten the flare nuts, A, B, C, D, connect the manifold valve charge hose to a charge port of the low-pressure valve on the gas pipe side.
2. Connect the charge hose connection to the vacuum pump.
3. Fully open the handle Lo of the manifold valve.
4. Operate the vacuum pump to evacuate. After starting evacuation, slightly loose the flare nut of the Lo valve on the gas pipe side and check that the air is entering (Operation noise of the vacuum pump changes and a compound meter indicates 0 instead of minus)

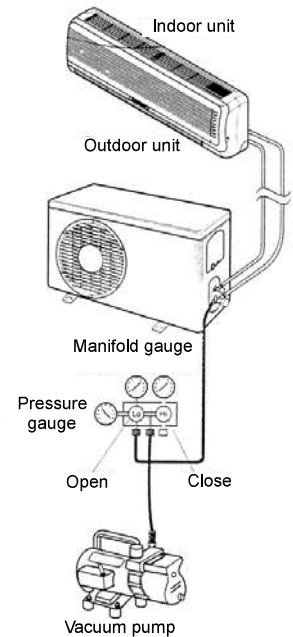
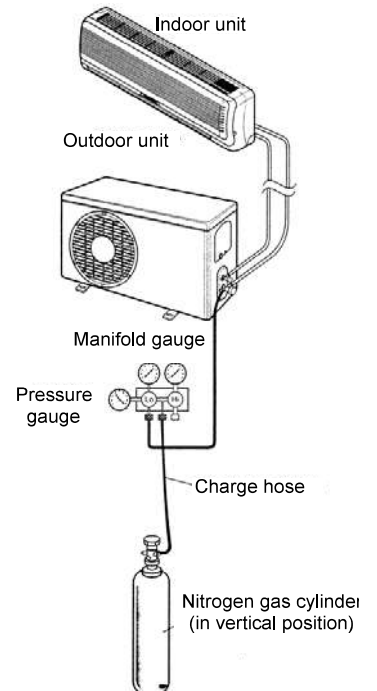

5. After the evacuation is complete, fully close the handle Lo of the manifold valve and stop the operation of the vacuum pump. Make evacuation for 15 minutes or more and check that the compound meter indicates -76cmHg (1x105Pa).
6. Turn the stem of the packed valve B about 45° counter clockwise for 6-7 seconds after the gas coming out, and then tighten the flare nut again. Make sure the pressure display in the pressure indicator is a little higher than the atmosphere pressure.
7. Remove the charge hose from the Low pressure charge hose.
8. Fully open the packed valve stems B and A.
9. Securely tighten the cap of the packed valve.

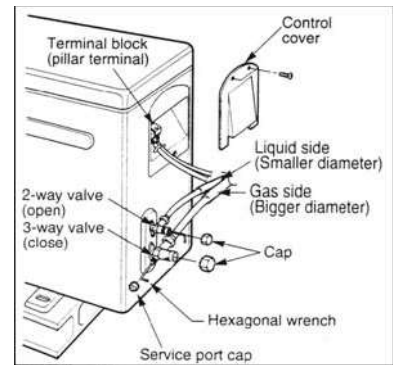

9. TEST OPERATION

- The test operation must be carried out after the entire installation has been completed.
- Please confirm the following points before the test operation:
 - The indoor unit and outdoor unit are installed properly.
 - Tubing and wiring are correctly completed.
 - The refrigerant pipe system is leakage-checked.
 - The drainage is unimpeded.
 - The heating insulation works well.
 - The ground wiring is connected correctly.
 - The length of the tubing and the added stow capacity of the refrigerant have been recorded.
 - The power voltage fits the rated voltage of the air conditioner.
 - There is no obstacle at the outlet and inlet of the outdoor and indoor units.
 - The gas-side and liquid-side stop valves are both opened.
 - The air conditioner is pre-heated by turning on the power.

TEST OPERATION

■ Set the air conditioner under the mode of "**COOLING**" with the remote controller, and check the following points. If there is any malfunction, please resolve it according to the chapter "**TROUBLESHOOTING**" of this Manual".

1) The indoor unit

- a) Whether the switch on the remote controller works well.
- b) Whether the buttons on the remote controller works well.
- c) Whether the air flow louver moves normally.
- d) Whether the room temperature is adjusted well.
- e) Whether the indicator lights normally.
- f) Whether the temporary buttons works well.
- g) Whether the drainage is normal.
- h) Whether there is vibration or abnormal noise during operation.
- i) Whether the air conditioner heats well.

2) The outdoor unit

- a) Whether there is vibration or abnormal noise during operation.
- b) Whether any of the refrigerant is leaked.



A protection feature prevents the air conditioner from being activated for approximately 3 minutes when it is restarted immediately after shut off.

* Cooper & Hunter is constantly working to improve their products, so the information in this manual is subject to change without prior notice.

ANNESI / ANNEXES / ANHÄNGE / ANEXOS / ANNEXES/ПРИЛОЖЕНИЯ

SCHEMI ELETTRICI / ELECTRIC SCHEMES / SCHALTPLÄNE / ESQUEMAS ELÉCTRICOS / SCHEMAS ELECTRIQUES / ЭЛЕКТРИЧЕСКИЕ СХЕМЫ

■ UNITÀ INTERNE / INDOOR UNITS / INNENEINHEITEN / UNIDADES INTERNAS / UNITÉS INTERNES/ ВНУТРЕННИЕ БЛОКИ Mod.: 2600 W, 3500 W

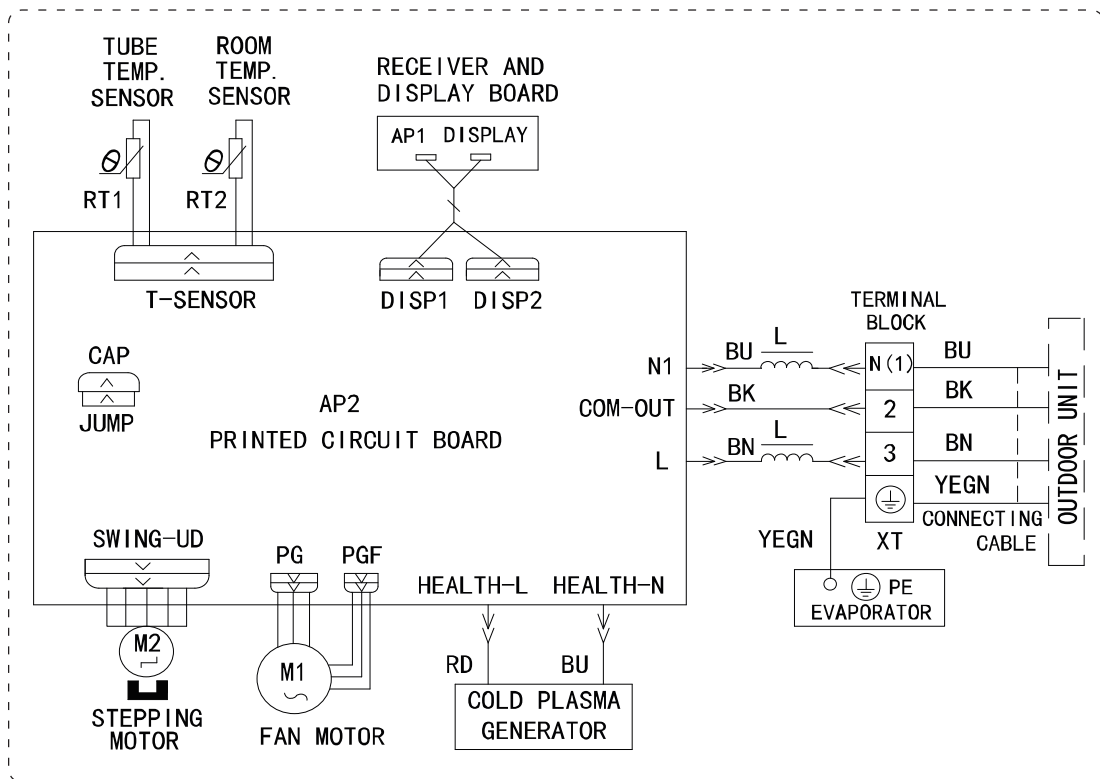

■ UNITÀ INTERNE / INDOOR UNITS / INNENEINHEITEN / UNIDADES INTERNAS / UNITÉS INTERNES/ ВНУТРЕННИЕ БЛОКИ Mod.: 5300 W, 7000 W

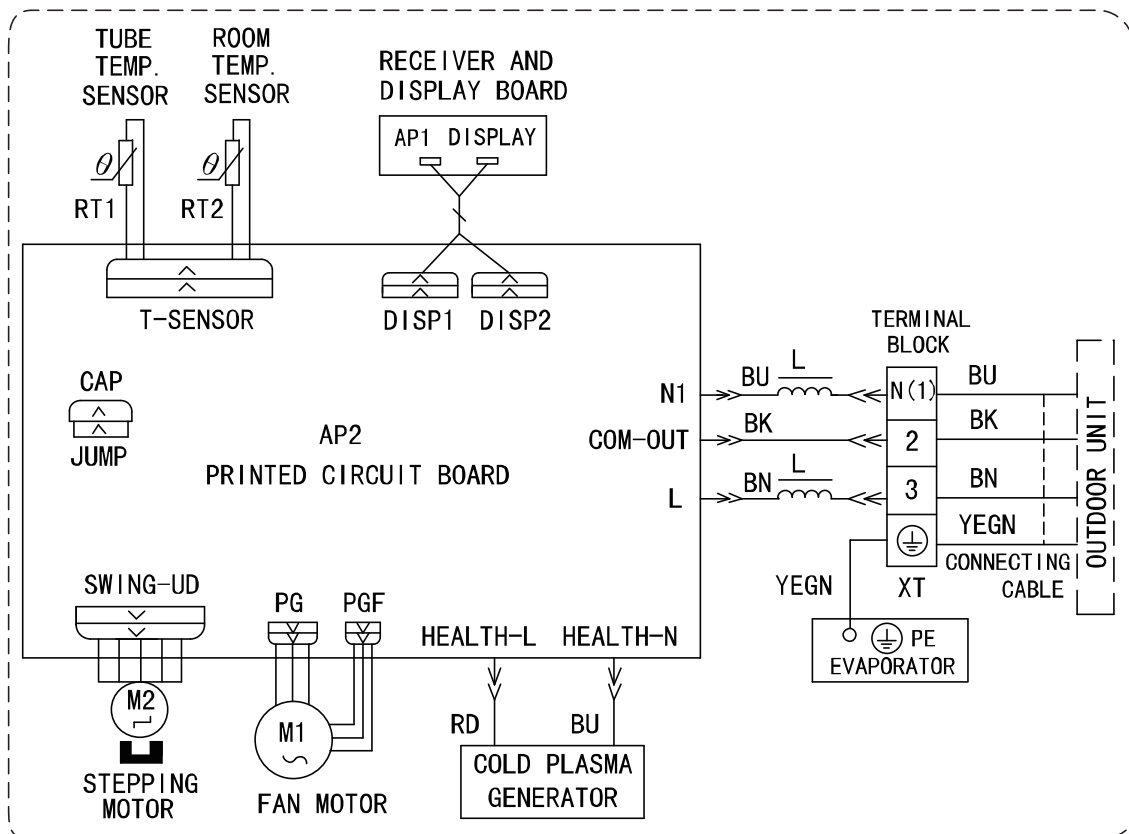

■ MONO DC INVERTER UNITÀ ESTERNA / OUTDOOR UNIT / AUßENEINHEIT / UNIDAD EXTERNA / UNITÉ EXTERNE/ НАРУЖНЫЙ БЛОК Mod.: 2600 W, 3500 W

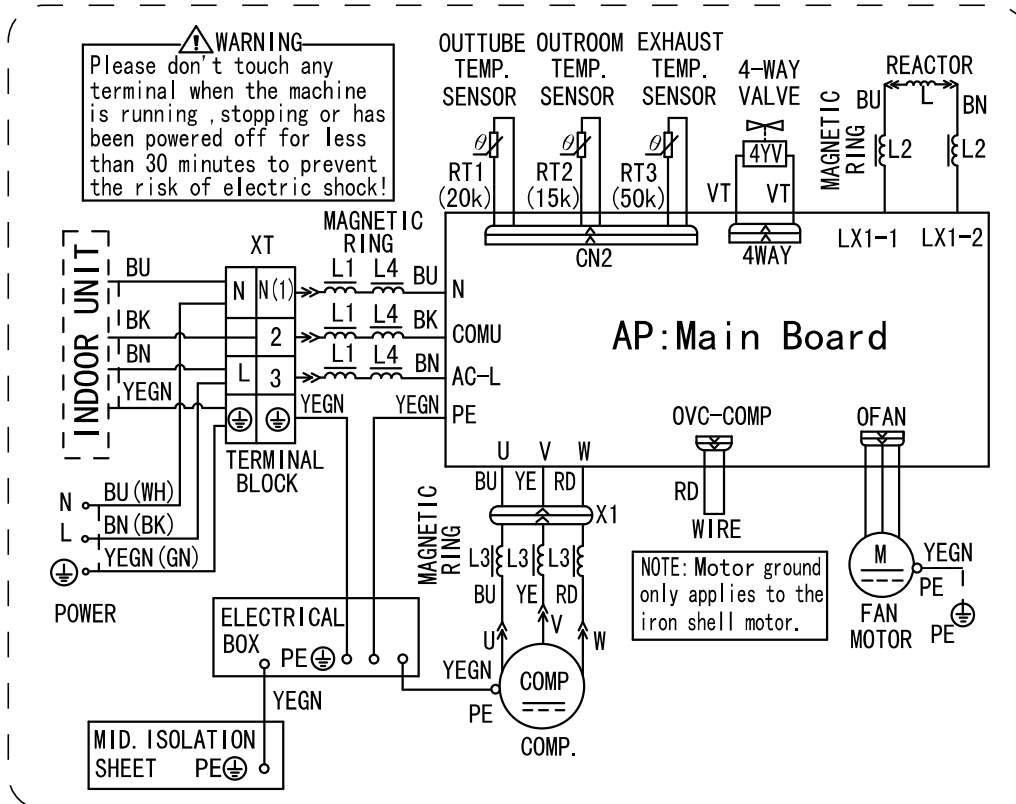

Mod.: 5300 W

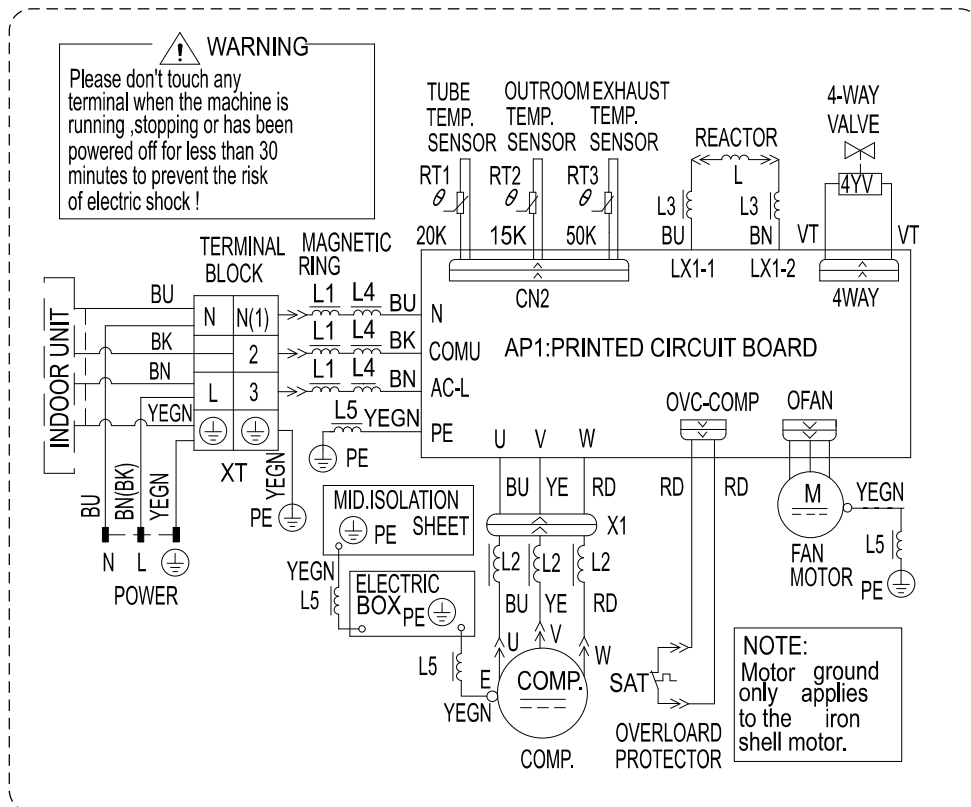

■ MONO DC INVERTER UNITÀ ESTERNA / OUTDOOR UNIT / AUßENEINHEIT / UNIDAD EXTERNA / UNITÉ EXTERNE/ НАРУЖНЫЙ БЛОК Mod.: 7000 W

