

MHI

Manual No. '07·SRK-T·068

TECHNICAL MANUAL

Collection data

WALL MOUNTED TYPE ROOM AIR-CONDITIONER

(Split system, air to air heat pump type)

SRK20HG-S

SRK28HG-S

SRK40HG-S

CONTENTS

1. GENERAL INFORMATION	1
1.1 Specific features	1
1.2 How to read the model name	1
2. SELECTION DATA	2
2.1 Specifications	2
2.2 Range of usage & limitations	5
2.3 Exterior dimensions	5
2.4 Piping system	7
2.5 Selection chart	8
3. ELECTRICAL DATA	9
3.1 Electrical wiring	9
4. OUTLINE OF OPERATION CONTROL BY MICROCOMPUTER	10
4.1 Operation control function by remote control switch	10
4.2 Unit ON/OFF button	11
4.3 Power blackout auto restart function	11
4.4 Custom cord switching procedure	12
4.5 Flap control	12
4.6 Timer operation	13
4.7 Outline of heating operation	14
4.8 Outline of cooling operation	17
4.9 Outline of dehumidifying operation	18
4.10 Outline of automatic operation	19
4.11 Outline of clean operation	19
4.12 Protective control function	20
5. APPLICATION DATA	22
5.1 Selection of location for installation	23
5.2 Installation of indoor unit	24
5.3 Installation of outdoor unit	27
5.4 Connection of refrigerant piping	27
5.5 Test run	29
5.6 Precautions for wireless remote control installation and operation	29
6. MAINTENANCE DATA	30
6.1 Trouble shooting	30
6.2 Servicing	35
7. REFRIGERANT PIPING INSTALLATION/SERVICING MANUAL FOR AIR CONDITIONERS USING R410A	36

1 GENERAL INFORMATION

1.1 Specific features

The “MITSUBISHI HEAVY INDUSTRIES, LTD.” room air-conditioner: SRK series are of split and wall mounted type and the unit consists of indoor unit and outdoor unit with refrigerant precharged in factory. The indoor unit is composed of room air cooling or heating equipment with operation control switch and the outdoor unit is composed of condensing unit with compressor.

(1) Remote control flap

The flap can be automatically controlled by operating wireless remote control.

- Swing: This will swing the flap up and down.
- Memory flap: Once the flap position is set, the unit memorizes the position and continues to operate at the same position from the next time.

(2) Automatic Operation

When the remote control switch is set on “auto(☉)”, it will either automatically decide operation mode such as cooling, heating and thermal dry, or operate in the operation mode before it has been turned to automatic control.

(3) Self diagnosis function

- We are constantly trying to do better service to our customers by installing such judges that show abnormality of operation as follows.

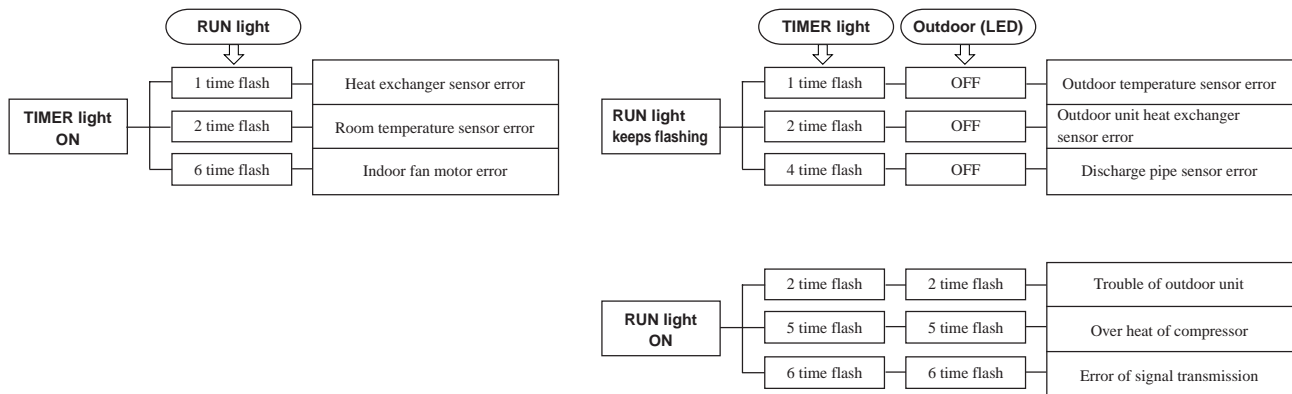

1.2 How to read the model name

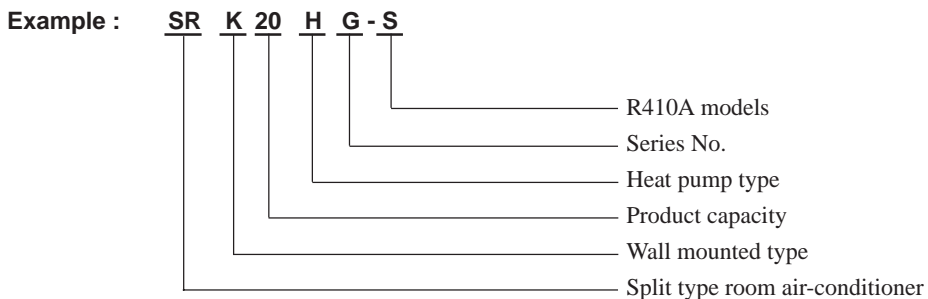

2 SELECTION DATA

2.1 Specifications

Model SRK20HG-S (Indoor unit)
SRC20HG-S (Outdoor unit)

(220/230/240V)

Item		Model	SRK20HG-S	SRC20HG-S	
Cooling capacity ⁽¹⁾		W	2070		
Heating capacity ⁽¹⁾		W	2220		
Power source			1 Phase, 220/230/240V, 50Hz		
Operation data ⁽¹⁾	Cooling input	kW	0.64		
	Running current (Cooling)	A	3.1/3.0/2.9		
	Heating input	kW	0.61		
	Running current (Heating)	A	3.0/2.9/2.8		
	Inrush current	A	18.9		
	COP			Cooling: 3.23 Heating: 3.64	
	Noise level	Cooling	Sound level	Hi: 34, Me: 30, Lo: 27	46
Power level			52	60	
Heating		Sound level	Hi: 34, Me: 31, Lo: 27	46	
		Power level	52	60	
Exterior dimensions		mm	268 × 790 × 199	540 × 780 × 290	
Height × Width × Depth					
Color			Fine snow	Stucco white	
Net weight		kg	8.5	29	
Refrigerant equipment					
Compressor type & Q'ty			-	RM-B5077MNE4 (Rotary type) × 1	
Motor		kW	-	0.65	
Starting method			-	Line starting	
Heat exchanger			Louver fins & inner grooved tubing	Straight fin & inner grooved tubing	
Refrigerant control			Capillary tubes + Electronic expansion valve		
Refrigerant ⁽³⁾		kg	R410A 0.95 (Pre-Charged up to the piping length of 15m)		
Refrigerant oil		ℓ	0.35 (MA68)		
Deice control			Microcomputer control		
Air handling equipment					
Fan type & Q'ty			Tangential fan × 1	Propeller fan × 1	
Motor		W	14	14	
Air flow (at High)	(Cooling)	CMM	7.5	27	
	(Heating)		7.5	27	
Air filter, Q'ty			Polypropylene net (washable) × 2	-	
Shock & vibration absorber			-	Cushion rubber (for compressor)	
Electric heater			-	-	
Operation control					
Operation switch			Wireless-Remote control	-	
Room temperature control			Microcomputer thermostat	-	
Pilot lamp			RUN (Green), TIMER (Yellow), HI POWER (Green), ECONO (Orange)		
Safety equipment			Frost protection, Serial signal error protection, Compressor overheat protection, High pressure control, Indoor fan motor error protection		
Refrigerant piping	O.D	mm (in)	Liquid line: φ6.35 (1/4") Gas line: φ9.52 (3/8")		
	Connecting method		Flare connecting		
	Attached length of piping		Liquid line: 0.4 m	-	
	Insulation		Gas line : 0.33 m		
Drain hose			Necessary (Both sides)		
Power source cord			Connectable		
Connection wiring			2 m (3 cores with Earth)		
Connection wiring	Size × Core number		1.5 mm ² × 4 cores (Including earth cable)		
	Connecting method		Terminal block (Screw fixing type)		
Accessories (included)			Mounting kit, Clean filter (Natural enzyme filter × 1, Photocatalytic washable deodorizing filter × 1)		
Optional parts			-		

Notes (1) The data are measured at the following conditions.

Operation	Item	Indoor air temperature		Outdoor air temperature		Standards
		DB	WB	DB	WB	
Cooling		27°C	19°C	35°C	24°C	ISO-T1, JIS C9612
Heating		20°C	-	7°C	6°C	ISO-T1, JIS C9612

The piping length is 7.5 m.

- (2) The operation data are applied to the 220/230/240V districts respectively.
 (3) The refrigerant quantity to be charged includes the refrigerant in 15 m connecting piping.
 (Purging is not required even for the short piping.)

Model SRK28HG-S (Indoor unit)
SRC28HG-S (Outdoor unit)

(220/230/240V)

Item		Model	SRK28HG-S	SRC28HG-S	
Cooling capacity ⁽¹⁾		W	2600		
Heating capacity ⁽¹⁾		W	2800		
Power source			1 Phase, 220/230/240V, 50Hz		
Operation data ⁽¹⁾	Cooling input		kW	0.81	
	Running current (Cooling)		A	3.8/3.7/3.6	
	Heating input		kW	0.77	
	Running current (Heating)		A	3.7/3.5/3.3	
	Inrush current		A	17.2	
	COP			Cooling: 3.21 Heating: 3.64	
	Noise level	Cooling	Sound level	dB	Hi: 39, Me: 33, Lo: 30
Power level			55		60
Heating		Sound level	dB	Hi: 40, Me: 33, Lo: 29	46
		Power level		56	60
Exterior dimensions Height × Width × Depth		mm	268 × 790 × 199	540 × 780 × 290	
Color			Fine snow	Stucco white	
Net weight		kg	8.5	31	
Refrigerant equipment Compressor type & Q'ty			-	5PS102DAB (Rotary type) × 1	
Motor		kW	-	0.7	
Starting method			-	Line starting	
Heat exchanger			Louver fins & inner grooved tubing	Straight fin & inner grooved tubing	
Refrigerant control			Capillary tubes + Electronic expansion valve		
Refrigerant ⁽³⁾		kg	R410A 0.85 (Pre-Charged up to the piping length of 15m)		
Refrigerant oil		ℓ	0.35 (RB68A)		
Deice control			Microcomputer control		
Air handling equipment Fan type & Q'ty			Tangential fan × 1	Propeller fan × 1	
Motor		W	14	15	
Air flow (at High)	(Cooling)	CMM	8.5	29	
	(Heating)		10.0	29	
Air filter, Q'ty			Polypropylene net (washable) × 2	-	
Shock & vibration absorber			-	Cushion rubber (for compressor)	
Electric heater			-	-	
Operation control			Wireless-Remote control	-	
Operation switch			Microcomputer thermostat	-	
Room temperature control			Microcomputer thermostat	-	
Pilot lamp			RUN (Green), TIMER (Yellow), HI POWER (Green), ECONO (Orange)		
Safety equipment			Frost protection, Serial signal error protection, Compressor overheat protection, High pressure control, Indoor fan motor error protection		
Refrigerant piping	O.D	mm (in)	Liquid line: φ6.35 (1/4") Gas line: φ9.52 (3/8")		
	Connecting method		Flare connecting		
	Attached length of piping		Liquid line: 0.4 m Gas line : 0.33 m	-	
	Insulation		Necessary (Both sides)		
Drain hose			Connectable		
Power source cord			2 m (3 cores with Earth)		
Connection wiring	Size × Core number		1.5 mm ² × 4 cores (Including earth cable)		
	Connecting method		Terminal block (Screw fixing type)		
Accessories (included)			Mounting kit, Clean filter (Natural enzyme filter × 1, Photocatalytic washable deodorizing filter × 1)		
Optional parts			-		

Notes (1) The data are measured at the following conditions.

Operation	Item	Indoor air temperature		Outdoor air temperature		Standards
		DB	WB	DB	WB	
Cooling		27°C	19°C	35°C	24°C	ISO-T1, JIS C9612
Heating		20°C	-	7°C	6°C	ISO-T1, JIS C9612

The piping length is 7.5 m.

- (2) The operation data are applied to the 220/230/240V districts respectively.
(3) The refrigerant quantity to be charged includes the refrigerant in 15 m connecting piping.
(Purging is not required even for the short piping.)

Model SRK40HG-S (Indoor unit)
SRC40HG-S (Outdoor unit)

(220/230/240V)

Item		Model	SRK40HG-S	SRC40HG-S	
Cooling capacity ⁽¹⁾		W	3600		
Heating capacity ⁽¹⁾		W	3920		
Power source			1 Phase, 220/230/240V, 50Hz		
Operation data ⁽¹⁾	Cooling input	kW	1.12		
	Running current (Cooling)	A	5.3/5.2/5.1		
	Heating input	kW	1.15		
	Running current (Heating)	A	5.4/5.3/5.2		
	Inrush current	A	25.2		
	COP			Cooling: 3.21 Heating: 3.41	
	Noise level	Cooling	Sound level	Hi: 40, Me: 38, Lo: 34	
Power level			56		
Heating		Sound level	Hi: 40, Me: 38, Lo: 34		
		Power level	57		
Exterior dimensions Height × Width × Depth		mm	268 × 790 × 199	540 × 780 × 290	
Color			Fine snow	Stucco white	
Net weight		kg	8.5	38	
Refrigerant equipment Compressor type & Q'ty			-	5KS150DBQ01 (Rotary type) × 1	
Motor		kW	-	1.1	
Starting method			-	Line starting	
Heat exchanger			Louver fins & inner grooved tubing	Straight fin & inner grooved tubing	
Refrigerant control			Capillary tubes + Electronic expansion valve		
Refrigerant ⁽³⁾		kg	R410A 1.15 (Pre-Charged up to the piping length of 15m)		
Refrigerant oil		ℓ	0.43 (RB68A or Freol Alpha 68M)		
Deice control			Microcomputer control		
Air handling equipment Fan type & Q'ty			Tangential fan × 1	Propeller fan × 1	
Motor		W	14	22	
Air flow (at High)	(Cooling)	CMM	9.0	32	
	(Heating)		10.0	32	
Air filter, Q'ty			Polypropylene net (washable) × 2	-	
Shock & vibration absorber			-	Cushion rubber (for compressor)	
Electric heater			-	-	
Operation control Operation switch			Wireless-Remote control	-	
Room temperature control			Microcomputer thermostat	-	
Pilot lamp			RUN (Green), TIMER (Yellow), HI POWER (Green), ECONO (Orange)		
Safety equipment			Frost protection, Serial signal error protection, Compressor overheat protection, High pressure control, Indoor fan motor error protection		
Refrigerant piping	O.D	mm (in)	Liquid line: φ6.35 (1/4") Gas line: φ12.7 (1/2")		
	Connecting method		Flare connecting		
	Attached length of piping		Liquid line: 0.4 m	-	
	Insulation		Gas line : 0.33 m	Necessary (Both sides)	
Drain hose			Connectable		
Power source cord			2 m (3 cores with Earth)		
Connection wiring	Size × Core number		1.5 mm ² × 4 cores (Including earth cable)		
	Connecting method		Terminal block (Screw fixing type)		
Accessories (included)			Mounting kit, Clean filter (Natural enzyme filter × 1, Photocatalytic washable deodorizing filter × 1)		
Optional parts			-		

Notes (1) The data are measured at the following conditions.

Operation	Item	Indoor air temperature		Outdoor air temperature		Standards
		DB	WB	DB	WB	
Cooling		27°C	19°C	35°C	24°C	ISO-T1, JIS C9612
Heating		20°C	-	7°C	6°C	ISO-T1, JIS C9612

The piping length is 7.5 m.

- (2) The operation data are applied to the 220/230/240V districts respectively.
(3) The refrigerant quantity to be charged includes the refrigerant in 15 m connecting piping.
(Purging is not required even for the short piping.)

2.2 Range of usage & limitations

Item	Models	All models
Indoor return air temperature (Upper, lower limits)		Cooling operation : Approximately 21 to 32°C Heating operation : Approximately 15 to 30°C
Outdoor air temperature (Upper, lower limits)		Cooling operation : Approximately 21 to 43°C Heating operation : Approximately -5 to 21°C
Refrigerant line (one way) length		Max. 15m
Vertical height difference between outdoor unit and indoor unit		Max. 10m (Outdoor unit is higher) Max. 10m (Outdoor unit is lower)
Power source voltage		Rating ± 10%
Voltage at starting		Min. 85% of rating
Frequency of ON-OFF cycle		Max. 10 times/h (Inching prevention 3 minutes)
ON and OFF interval		Max. 3 minutes

2.3 Exterior dimensions

(1) Indoor unit

Models All models

Unit: mm

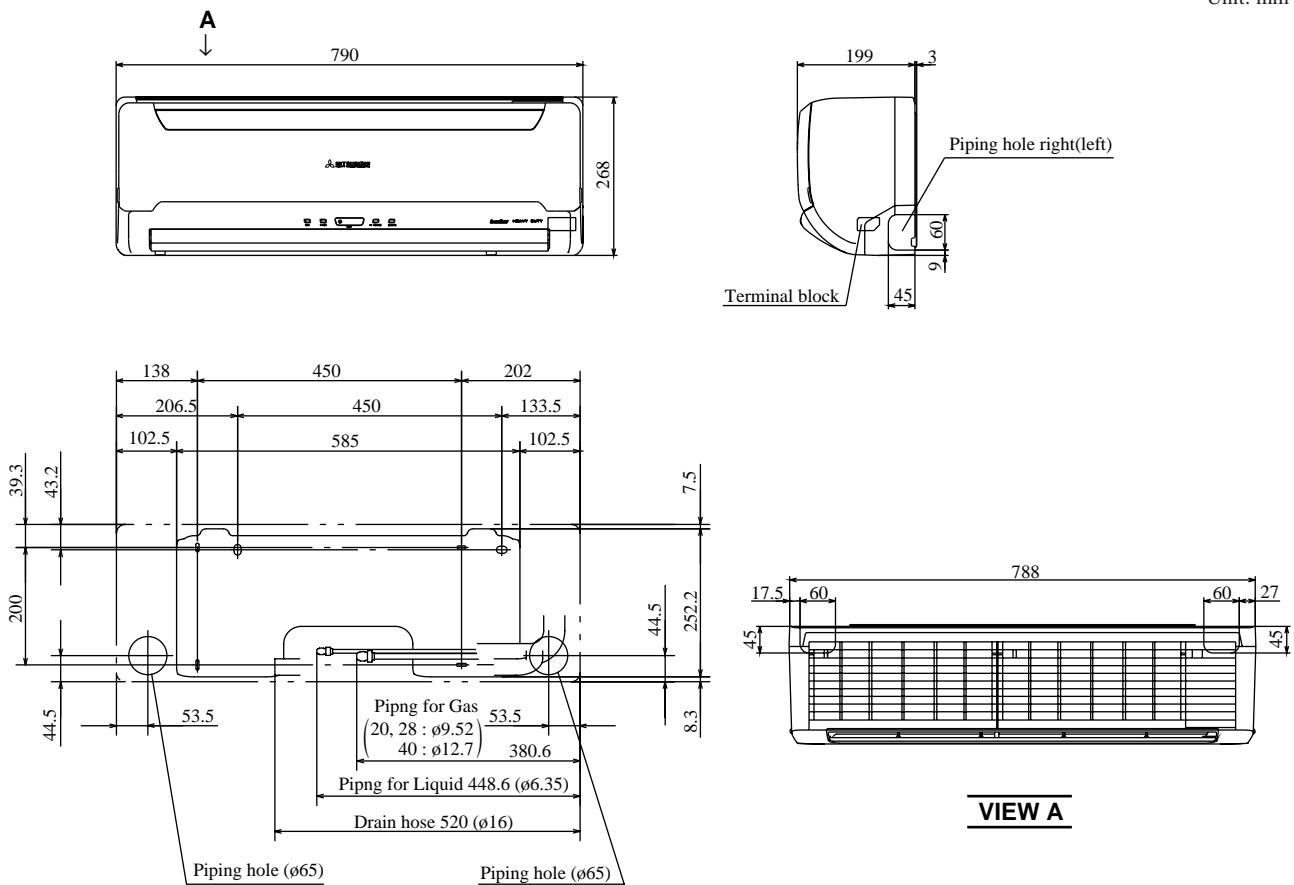

(2) Outdoor unit

Models All models

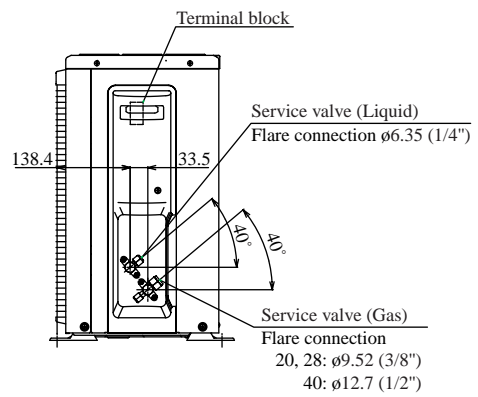
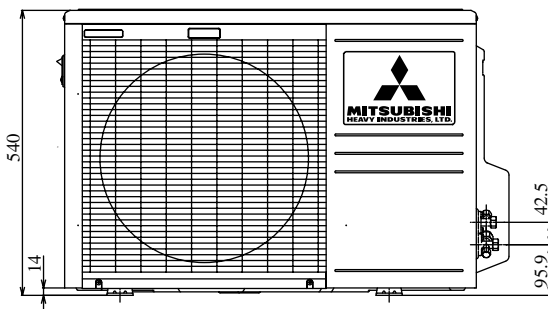
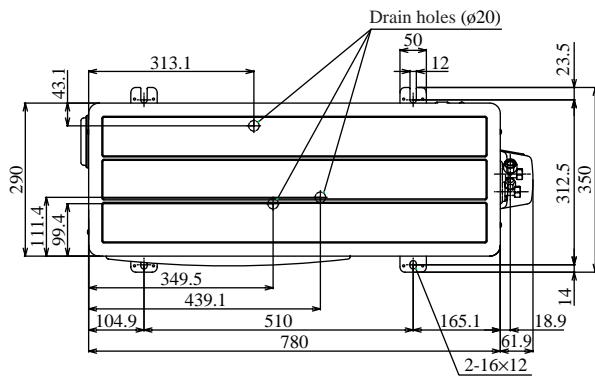

2.4 Piping system

Models SRK20HG-S, 28HG-S, 40HG-S

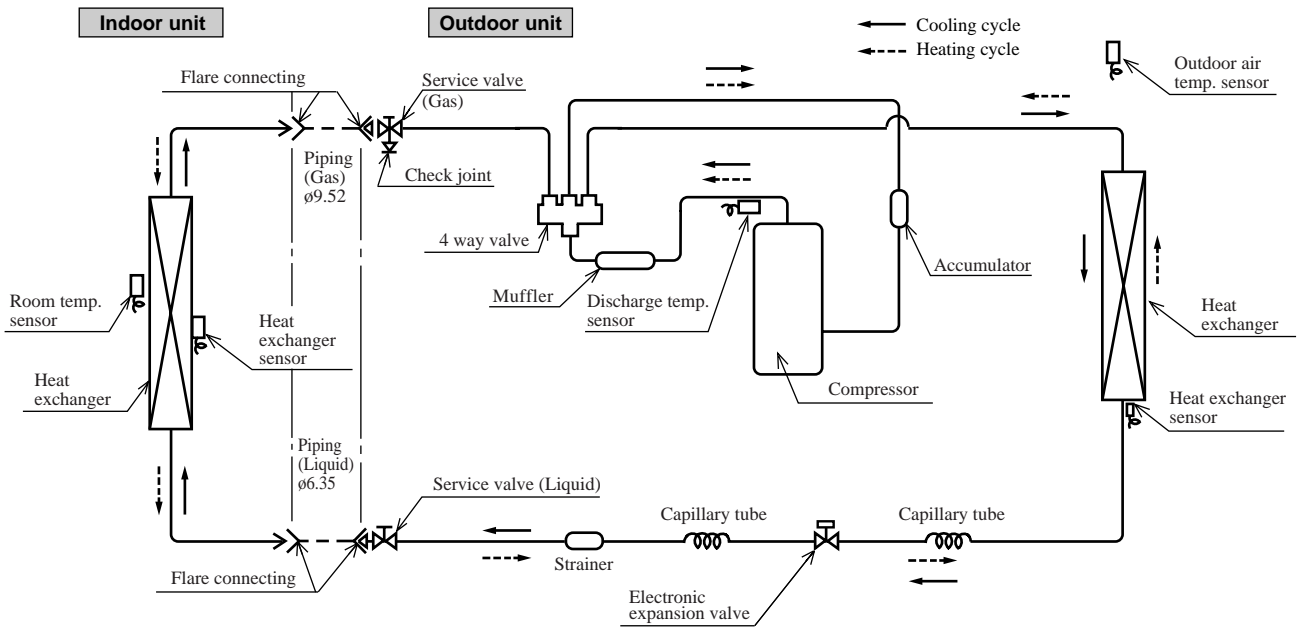

2.5 Selection chart

Correct the cooling and heating capacity in accordance with the conditions as follows. The net cooling and heating capacity can be obtained in the following way.

Net capacity = Capacity shown on specification × Correction factors as follows.

(1) Coefficient of cooling and heating capacity in relation to temperatures

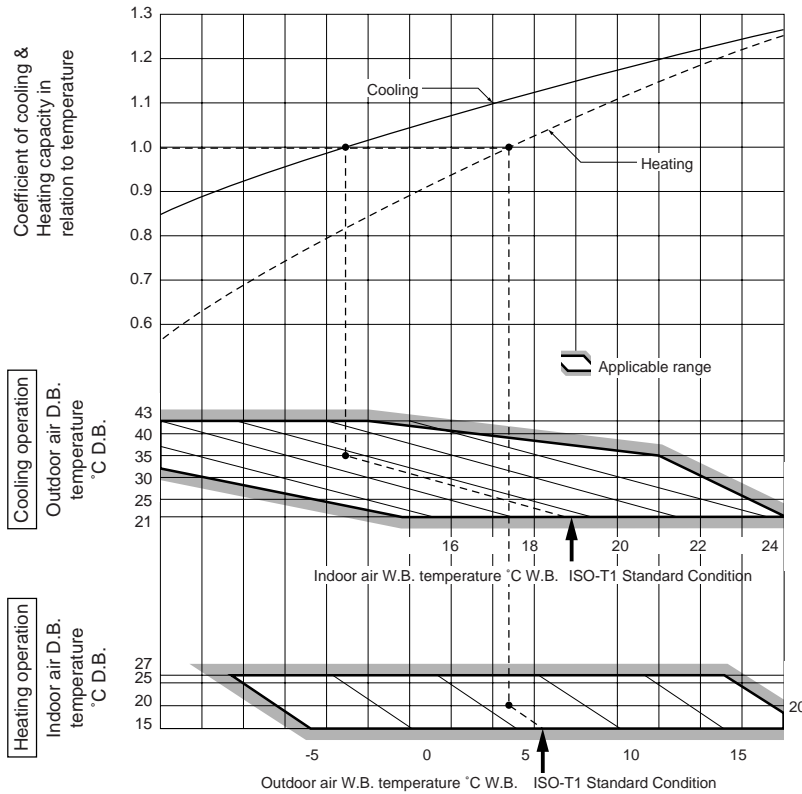

(2) Correction of cooling and heating capacity in relation to one way length of refrigerant piping

It is necessary to correct the cooling and heating capacity in relation to the one way piping length between the indoor and outdoor units.

Piping length [m]	7	10	15
Cooling	1.0	0.99	0.975
Heating	1.0	1.0	1.0

(3) Correction relative to frosting on outdoor heat exchanger during heating

In additions to the foregoing corrections (1), (2) the heating capacity needs to be adjusted also with respect to the frosting on the outdoor heat exchanger.

Air inlet temperature of outdoor unit in °CWB	-5	-3	-1	1	3	5
Adjustment coefficient	0.91	0.88	0.86	0.87	0.92	1.00

How to obtain the cooling and heating capacity

Example : The net cooling capacity of the model SRK20HG-S with the piping length of 15m, indoor wet-bulb temperature at 19.0°C and outdoor dry-bulb temperature 35°C is Net cooling capacity =

$$\begin{array}{ccccccc}
 \frac{2070}{\uparrow} & \times & \frac{0.975}{\uparrow} & \times & \frac{1.0}{\uparrow} & = & 2018 \text{ W} \\
 \text{SRK20HG-S} & & \text{Length 15m} & & \text{Factor by air} & & \\
 & & & & \text{temperatures} & &
 \end{array}$$

3 ELECTRICAL DATA

3.1 Electrical wiring

Models SRK20HG-S, 28HG-S, 40HG-S

Power source
1 Phase
220/230/240V 50Hz

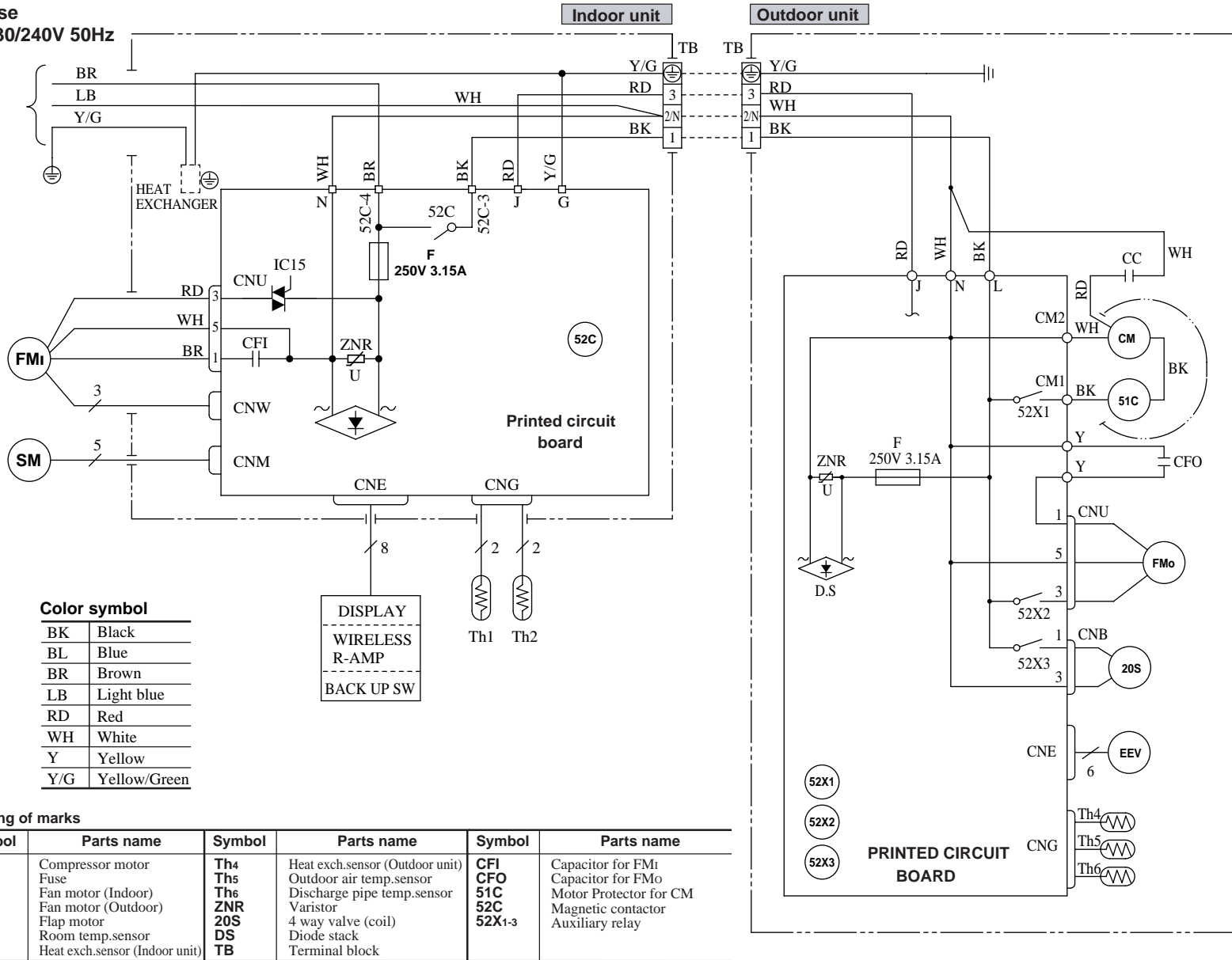

4 OUTLINE OF OPERATION CONTROL BY MICROCOMPUTER

4.1 Operation control function by remote control switch

Remote control

Models All models

◆ Operation selection

FAN SPEED button

Each time the button is pushed, the ■ indicator is switched over in turn.

HI POWER/ECONO button

This button changes the HIGH POWER/ECONOMY mode.

TEMPERATURE button

This button sets the room temperature.
(This button changes the present time and TIMER time.)

ON TIMER button

This button selects ON TIMER operation.

SLEEP button

This button selects SLEEP operation.

CLEAN switch

This switch changes the CLEAN mode.

OPERATION MODE select button

Each time the button pushed, the ■ indicator is switched over in turn.

ON/OFF (luminous) button

Press for starting operation, press again for stopping.

AIR FLOW (UP/DOWN) button

This button changes the air flow (up/down) mode.

OFF TIMER button

This button selects OFF TIMER operation.

RESET switch

Switch for resetting microcomputer and setting time.

CANCEL button

This button cancels the ON timer, OFF timer, and SLEEP operation.

• The above illustration shows all controls, but in practice only the relevant parts are shown.

◆ Indication selection

CLEAN indicator

Indicates during CLEAN operation.

SLEEP indicator

Indicates during SLEEP operation.

TEMPERATURE indicator

Indicates set temperature.
(Does not indicate temperature when operation mode is on AUTO)

FAN SPEED indicator

Indicates set air flow rate with ■ lamp.

HI POWER/ECONO MODE indicator

Indicates during HIGH POWER/ECONOMY mode operation.

ON/OFF TIMER indicator

Indicates during ON/OFF TIMER operation.

OPERATION MODE indicator

Indicates selected operation with ■ lamp.
[☉ (Auto) • ❄️ (Cool) • 🔥 (Heat) • ☪️ (Dry)]

TIME indicator

Indicates present time or timer setting time.

AIR FLOW indicator

Shows selected flap mode.

Unit indication selection

Models All models

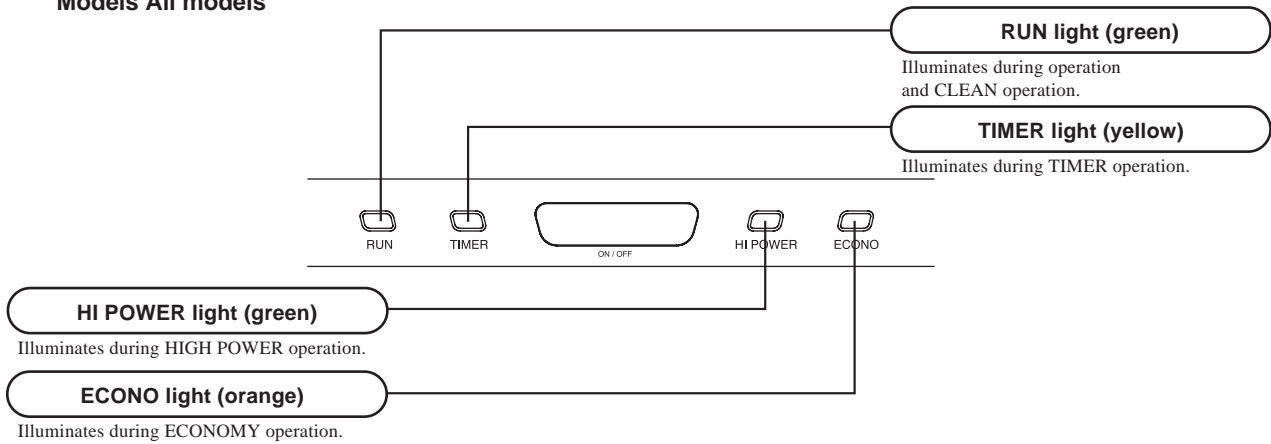

4.2 Unit ON/OFF button

When the remote control batteries become weak, or if the remote control is lost or malfunctioning, this button may be used to turn the unit on and off.

(1) Operation

Push the button once to place the unit in the automatic mode. Push it once more to turn the unit off.

(2) Details of operation

The unit will go into the automatic mode in which it automatically determines, from room temperature (as detected by sensor), whether to go into the cooling, thermal dry or heating modes.

Function / Operation mode	Room temperature setting	Fan speed	Flap	Timer switch
Cooling	About 24°C	Auto	Auto	Continuous
Thermal dry	About 24°C			
Heating	About 26°C			

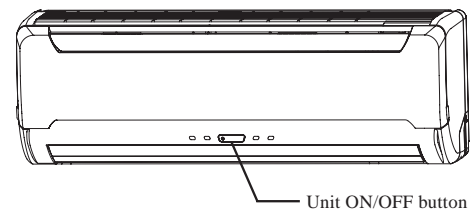

4.3 Power blackout auto restart function

(1) Power blackout auto restart function is a function that records the operational status of the air-conditioner immediately prior to it being switched off by a power cut, and then automatically resumes operations at that point after the power has been restored.

(2) The following settings will be cancelled:

- (a) Timer settings
- (b) High-power operations

- Notes
- (1) The power blackout auto restart function is set at on when the air-conditioner is shipped from the factory. Consult with your dealer if this function needs to be switched off.
 - (2) When power failure occurs, the timer setting is cancelled. Once power is resumed, reset the timer.
 - (3) If the jumper wire (J7) "AUTO RESTART" is cut, auto restart is disabled. (See the diagram at right)

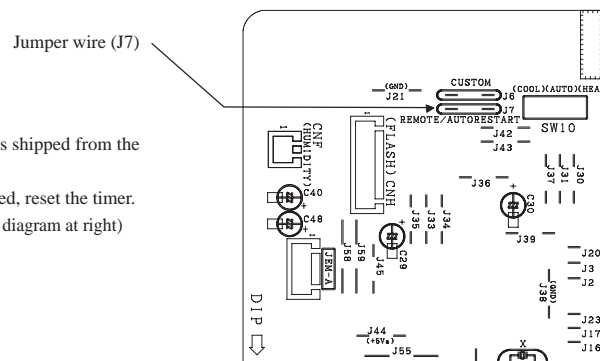

4.4 Custom cord switching procedure

If two wireless remote controls are installed in one room, in order to prevent wrong operation due to mixed signals, please modify the printed circuit board in the indoor unit's control box and the remote control using the following procedure. Be sure to modify both boards. If only one board is modified, receiving (and operation) cannot be done.

(1) Modifying the indoor unit's printed circuit board

Take out the printed circuit board from the control box and cut off jumper wire (J6) using wire cutters.

After cutting of the jumper wire, take measures to prevent contact with the other the lead wires, etc.

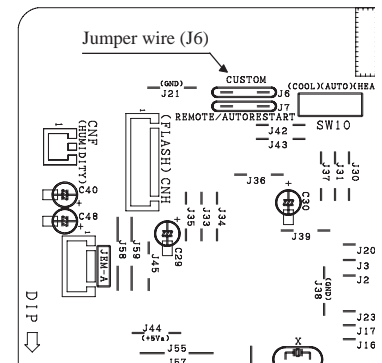

(2) Modifying the wireless remote control

- (a) Remove the battery.
- (b) Cut the jumper wire shown in the figure at right.

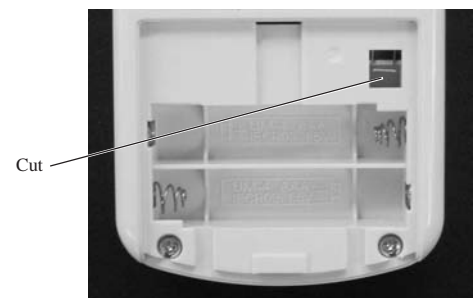

4.5 Flap control

Control the flap by AIRFLOW button on the wireless remote control.

(1) Swing flap

Flap moves in upward and downward directions continuously.

(2) When not operating

The flap returns to the position of air flow directly below, when operation has stopped.

(3) Memory flap (Flap stopped)

When you press the AIRFLOW button once while the flap is operating, it stops swinging at an angle. Since this angle is memorized in the microcomputer, the flap will automatically be set at this angle when the next operation is started.

- Recommendable stopping angle of the flap

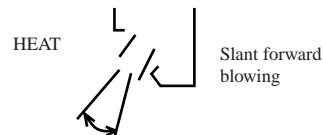
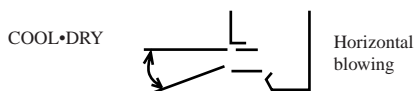

4.6 Timer operation

(1) Comfortable timer setting (ON timer)

If the timer is set at ON when the operation select switch is set at the cooling or heating, or the cooling or heating in auto mode operation is selected, the comfortable timer starts and determines the starting time of next operation based on the initial value of 15 minutes and the relationship between the room temperature at the setting time (temperature of room temperature sensor) and the setting temperature. (Max. 60 minutes)

Operation mode	Operation start time correction value (Min.)		
	At cooling	$3 < \text{Room temp.} - \text{Setting temp.}$ +5	$1 < \text{Room temp.} - \text{Setting temp.} \leq 3$ No change
At heating	$3 < \text{Setting temp.} - \text{Room temp.}$ +5	$2 < \text{Setting temp.} - \text{Room temp.} \leq 3$ No change	$\text{Setting temp.} - \text{Room temp.} \leq 2$ -5

Notes (1) At 5 minutes before the timer ON time, operation starts regardless of the temperature of the room temperature sensor (Th1).

(2) This function does not operate when in the Dry or Auto Dry mode.

However, the operation in item (1) does operate in the Auto Dry mode.

(3) During the comfortable timer operation, both the RUN light and TIMER light illuminate and the TIMER light goes off after expiration of the timer, ON setting time.

(Example) Heating

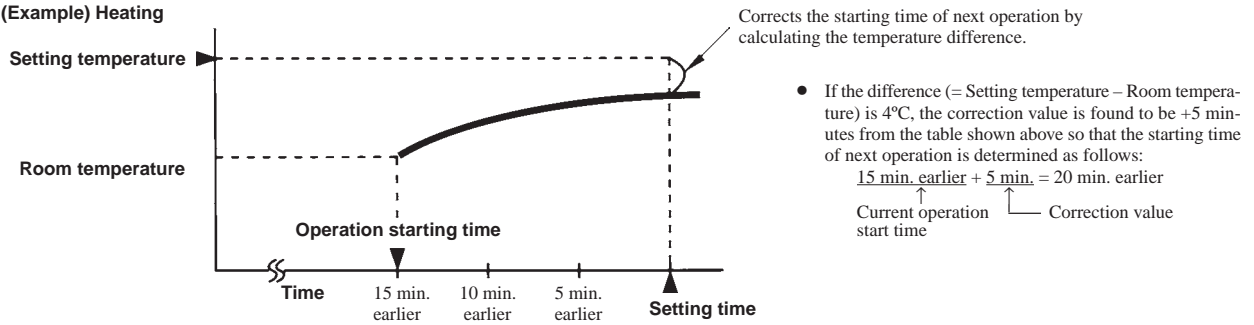

(2) Sleep timer operation

Pressing the SLEEP button causes the temperature to be controlled as shown in the following chart with respect to the set temperature.

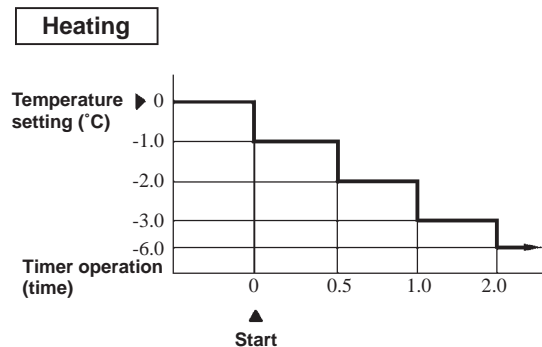
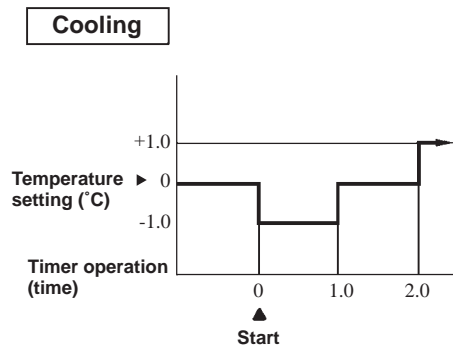

(3) OFF timer operation

The Off timer can be set at a specific time (in 10-minute units) within a 24-hour period.

4.7 Outline of heating operation

(1) Operation of major functional components

Functional components \ Item	When the compressor command is OFF	When the compressor command is ON	When the compressor goes OFF due to an anomalous stop.
Indoor fan motor	ON	ON	OFF
Flaps	ON or OFF	ON or OFF	Stop position control
Display	Lights up	Lights up	Lights up or flashes
52C	ON	ON	Depending on the stop mode
Outdoor fan motor	Depending on the stop mode	ON	
4-way valve		ON	

(2) Fan speed switching

Fan speed switching \ Flow control	AUTO	HIGH	MED	LOW
Swing flap	Auto fan control	Speed 7	Speed 5	Speed 3
Swing stop		Speed 7	Speed 5	Speed 3

(a) Auto fan control

The indoor fan is automatically controlled in accordance with the difference between the room temperature (detected by the room temperature sensor) and the thermostat setting as shown below.

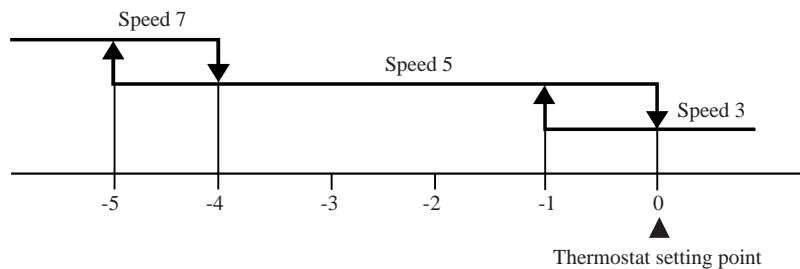

(3) Thermostat operation

The compressor and outdoor fan are turned on and off as shown below according to the temperature setting.

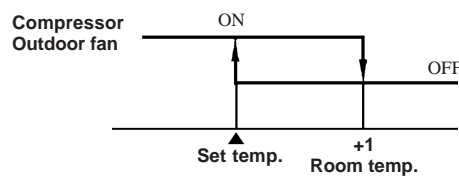

(4) Hot keep

This function controls the indoor unit fan speed as shown below in accordance with the temperature sensed by the indoor heat exchanger sensor.

(a) When the compressor and outdoor unit fan are operating

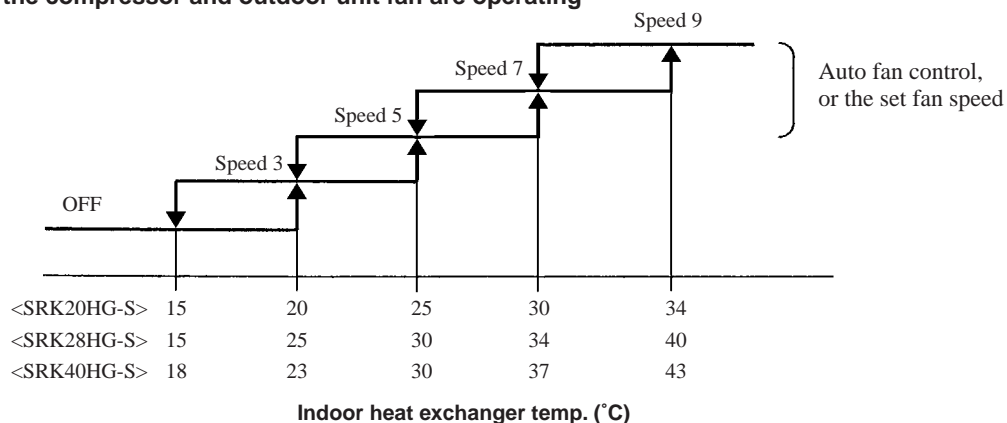

(b) When the compressor and outdoor fan are stopped

1) While the compressor operation is delayed.

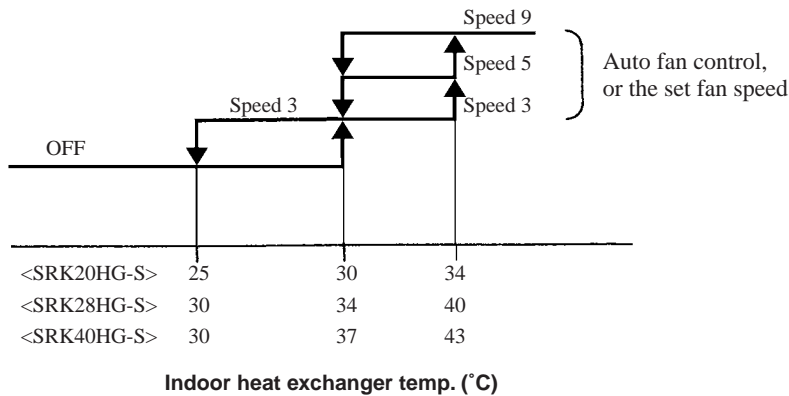

2) Up until 5 minutes have passed since the end of a compressor start delay operation, when 52C goes OFF, the indoor unit's fan speed changes forcibly from OFF to speed 1.

(c) To accomplish rapid recovery from the thermostat off state, after the compressor and outdoor unit's fan go OFF, the set temperature is raised by 1°C until 1 minute passes after the hot keep end temperature has been reached following restarting.

(5) Hot spurt

- (a) For 40 minutes after a heating operation begins, the system runs with set temperature raised by 2°C.
- (b) In the following cases, this function is canceled and does not activate afterwards.
 - 1) When the compressor and outdoor unit fan have been turned OFF by the thermostat going off.
 - 2) During high pressure control operation.

(6) HIGH POWER operation ("HI POWER" button on the remote control : ON)

The system runs under the following conditions for 15 minutes without relation to the set temperature or the fan speed setting.

Indoor unit fan	SRK20HG-S : Speed 8 fixed SRK28HG-S, 40HG-S : Speed 9 fixed
Outdoor unit fan	ON
Compressor	ON

- Notes (1) Room temperature is not adjusted during the HIGH POWER operation.
 (2) Protective function will actuate with priority even during the HIGH POWER operation.

(7) Defrost operation

- (a) Starting conditions (Defrost operation begins when all the following conditions are satisfied.)
 - ① 40 minutes have passed since the heating operation began. (Accumulated operation time)
 - ② 40 minutes have passed since the previous defrosting operation ended. (Accumulated operation time)
 - ③ The outdoor unit heat exchanger sensor temperature is -5°C or lower continuously for 3 minutes.
 - ④ The difference between the outdoor air temperature sensor temperature and the outdoor heat exchange sensor temperature is $\geq 4.5^\circ\text{C}$.
 - ⑤ The compressor is running.

Also, the number of times the compressor goes OFF is counted, and when it reaches 10 or more times, if the conditions in ①, ②, ③ (except that the outdoor heat exchanger sensor temperature is -1°C) and ⑤ above and the outdoor air temperature is 3°C or lower (SRK20HG-S only), the defroster operation starts.
- (b) End conditions (when either of the following conditions is satisfied)
 - ① Outdoor heat exchanger sensor temperature: 9°C or higher
 - ② Defrosting operation has continued for 10 minutes.

(c) Operation of functional components during defrosting operation

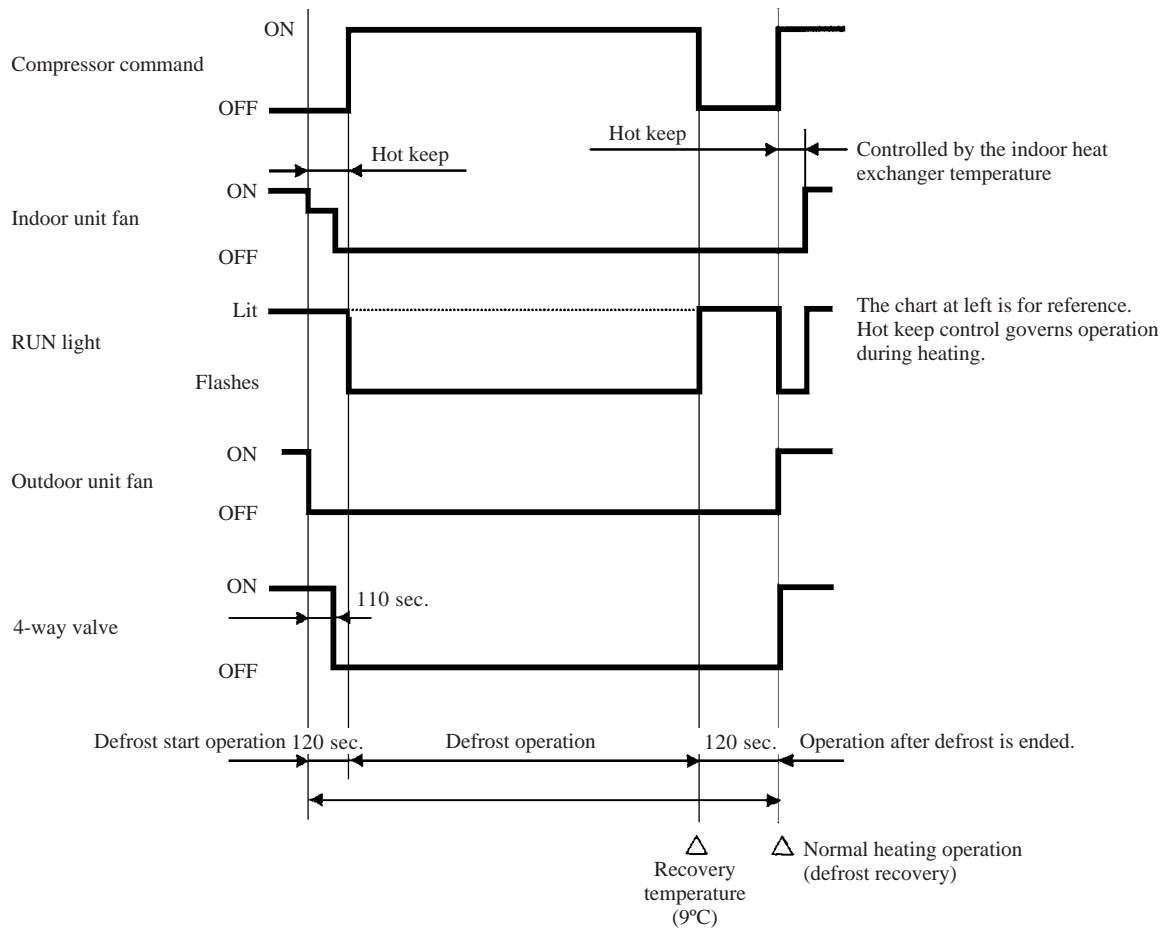

(8) Forced defrost

(a) During trial operation, if defrost operation is performed, defrost operation can be performed only once time, in accordance with the following operation.

1) Remote control operation

Operation	Run
Operation mode	Heating
Set temperature	19°C
Fan speed select	Low
Air flow setting	Swing
On timer	ON
Current time	On after 180 min.condition
On timer time	

2) Functional components operation

Compressor	ON
4-way valve	OFF
Indoor unit fan	OFF
Flap	Fully closed
Outdoor unit fan	OFF
Display	Same as defrost

(b) If remote control operation is performed, for 1 minute after 3-minute timer operation, the operation is canceled if one of the following conditions is satisfied.

- ① Outdoor heat exchanger sensor temperature: 14°C or higher
- ② 10 minutes has passed (including the 1 minute of forced operation).

(9) ECONOMY operation ("ECONO" button on the remote control : ON)

The set temperature changes as shown at right and the indoor unit fan runs at speed 4.

Running time	Set temperature compensation
Running start ~ 1 hour	Set temperature -1.0
1~2 hours	Set temperature -2.0
2 hours ~	Set temperature -2.5

4.8 Outline of cooling operation

(1) Operation of major functional components

Functional components \ Item	When the compressor command is OFF	When the compressor command is ON	When the compressor goes OFF due to an anomalous stop.
Indoor fan motor	ON	ON	OFF
Flaps	ON or OFF	ON or OFF	Stop position control
Display	Lights up	Lights up	Lights up or flashes
52C	ON	ON	Depending on the stop mode
Outdoor fan motor	Depending on the stop mode	ON	
4-way valve		OFF	

(2) Fan speed switching

Fan speed switching \ Flow control	AUTO	HIGH	MED	LOW
Swing flap	Auto fan control	Speed 6	Speed 4	Speed 2
Swing stop		Speed 6	Speed 4	Speed 2

(a) Auto fan control

The indoor fan is automatically controlled in accordance with the difference between the room temperature (detected by the room temperature sensor) and the thermostat setting as shown below.

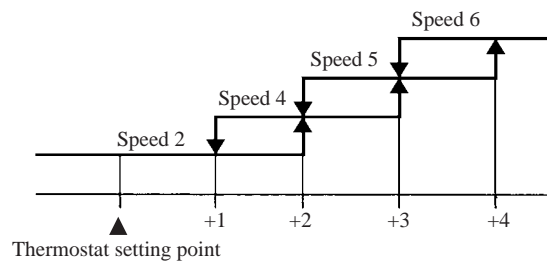

(3) Thermostat operation

The compressor and outdoor fan are turned on and off as shown below according to the temperature setting.

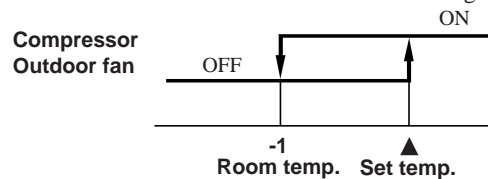

(4) HIGH POWER operation ("HI POWER" button on the remote control : ON)

The following operation is performed for 15 minutes without relation to the set temperature or fan speed setting.

Indoor unit fan	Speed 8 fixed
Outdoor unit fan	ON
Compressor	ON

- Notes (1) Room temperature is not adjusted during the HIGH POWER operation.
 (2) Protective functions will actuate with priority even during the HIGH POWER operation.

(5) ECONOMY operation ("ECONO" button on the remote control : ON)

The set temperature changes as shown at right, and the indoor unit fan speed is set on speed 2.

Running time	Set temperature compensation
Running start ~ 1 hour	Set temperature +0.5
1~2 hours	Set temperature +1.0
2 hours ~	Set temperature +1.5

4.9 Outline of dehumidifying operation

- (1) Choose the appropriate operation block area by the difference between room temperature and thermostat setting temperature as shown below.

• **Operation block area**

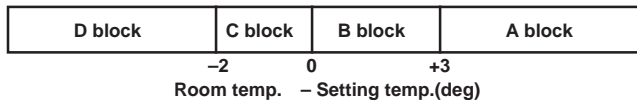

- (2) **Start up operation**

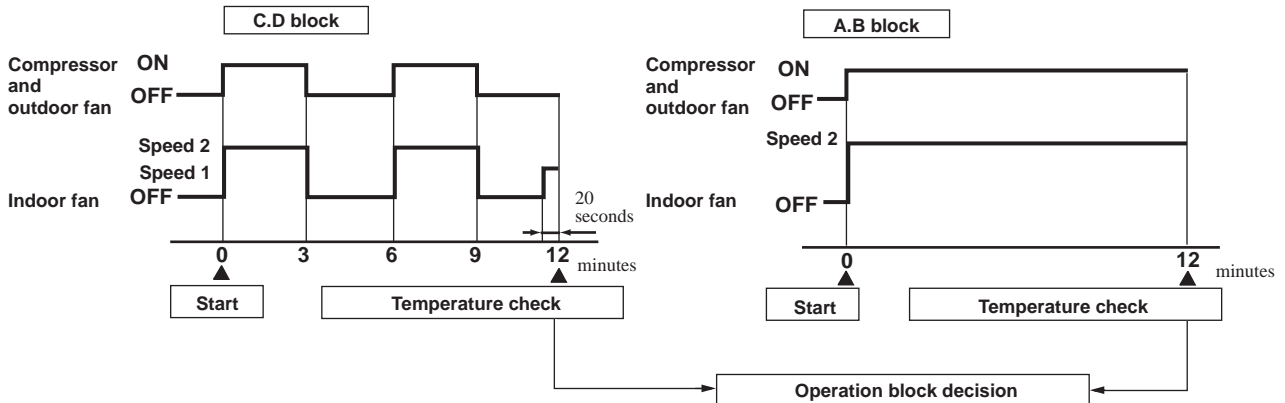

Note (1) Thermostat operation is performed in A, B block. When compressor and indoor fan stop by thermostat operation within 12 minutes from start, temperature check is performed by operating indoor fan at speed 1 for 20 seconds before finishing 12 minutes and allowing decision of next operation block.

- (3) **DRY operation**

After finishing start up operation described in (2) above, thermal dry operation is performed at 8 minutes intervals, according to the difference between room temperature and thermostat setting temperature as shown below.

Beside, 1 cycle of this operating time consists of 8 minutes, 7 cycle operation is performed then.

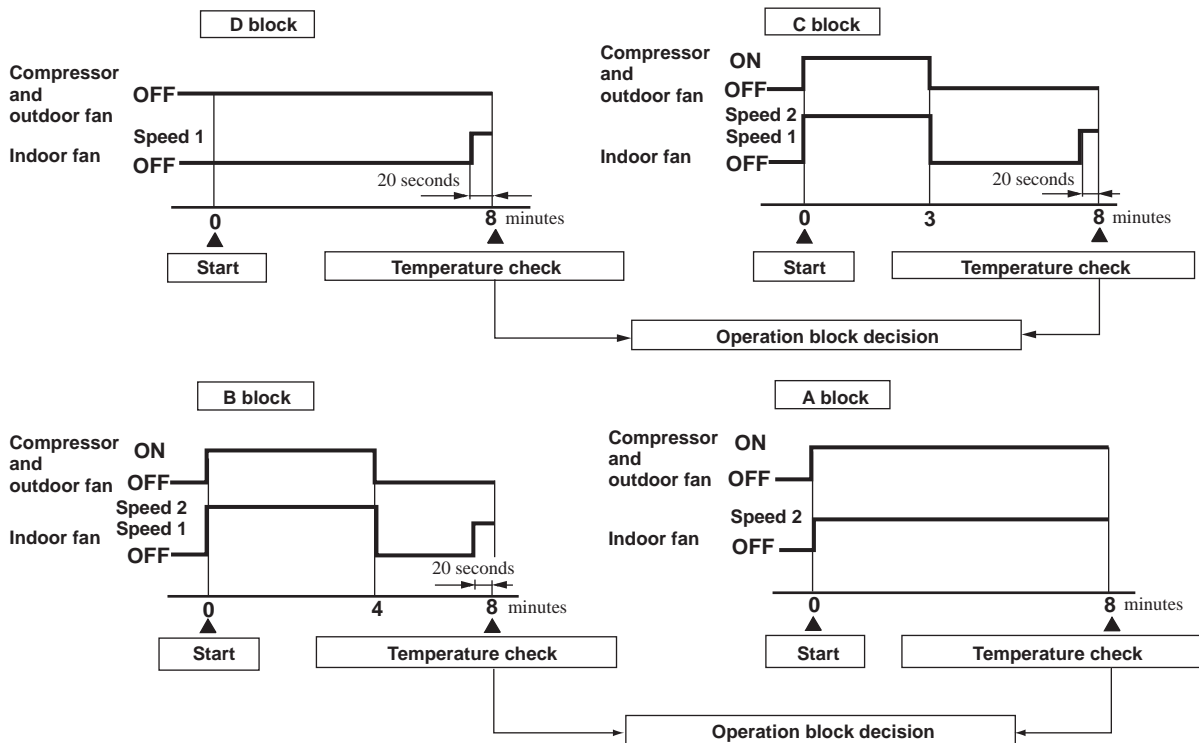

- (4) **ECONOMY operation ("ECONO" button on the remote control : ON)**

The set temperature changes as shown at right, and the indoor unit fan speed is set on speed 2.

Running time	Set temperature compensation
Running start ~ 1 hour	Set temperature +0.5
1~2 hours	Set temperature +1.0
2 hours ~	Set temperature +1.5

4.10 Outline of automatic operation

(1) Determination of operation mode

The unit checks the room temperature and the outdoor air temperature after operating the indoor and outdoor blowers for 20 seconds, determines the operation mode and the room temperature setting correction value, and then begins in the automatic operation.

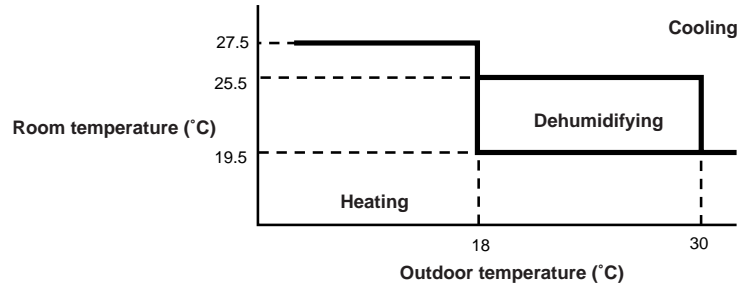

- (2) The unit checks the temperature every 30 minutes after the start of operation and, if the result of check is not same as the previous operation mode, changes the operation mode.
- (3) When the unit is started again within 30 minutes after the stop of automatic operation or when the automatic operation is selected during heating, cooling or dehumidifying operation, the unit is operated in the previous operation mode.
- (4) Setting temperature can be adjusted within the following range. There is the relationship as shown below between the signals of the wireless remote control and the setting temperature.

		Signals of wireless remote control (Display)												
		-6	-5	-4	-3	-2	-1	±0	+1	+2	+3	+4	+5	+6
Setting temperature	Cooling	18	19	20	21	22	23	24	25	26	27	28	29	30
	Dehumidifying	18	19	20	21	22	23	24	25	26	27	28	29	30
	Heating	20	21	22	23	24	25	26	27	28	29	30	31	32

4.11 Outline of clean operation

COOL,DRY,AUTO (COOL,DRY); after operation has stopped, the moisture inside the dryer air conditioner, controls the production of fungus etc.

(1) Operating condition

'Clean' is switched ON, when the air conditioner receives a STOP signal.

(2) Detail of operation

Compressor	OFF
Indoor fan motor	Speed 1
Outdoor fan motor	OFF
Flap	Fully closed

(3) Reset condition

When control finishes 120 minutes after the Clean operation starts. When the stop signal is received from the remote control.

4.12 Protective control function

(1) Frost prevention for indoor heat exchanger (During cooling or dehumidifying)

(a) Operating conditions

- (i) Indoor heat exchanger temperature (detected with Th2) is lower than 2.5°C.
- (ii) 3 minutes elapsed after the start of operation.

(b) Detail of anti-frost operation

Compressor	OFF
Indoor fan	Protects the fan tap just before frost prevention control
Outdoor fan	OFF
4-way valve	Stop mode

(c) Reset condition: Indoor heat exchanger temperature (Th2) is higher than 8°C.

(2) Indoor fan motor protection

When the air conditioner is operating and the indoor fan motor is turned ON, if the indoor fan motor has operated at 300 rpm or under for more than 30 seconds, the unit enters first in the stop mode and then stops the entire system.

TIMER light illuminates simultaneously and the RUN light flashing 6 times at each 8-second.

(3) Three-minute forced operation

When the compressor begins operating the thermal operation is not effective for 3 minutes, so operation continues as is in the operation mode. (After 3 minutes has passed the thermal operation is effective.)

However, stopping the compressor via a stop signal or protection control has priority.

(4) High-pressure control

The indoor heat exchanger sensor detection temperature controls the outdoor fan and compressor.

- When the indoor heat exchanger temperature is $\geq 58^{\circ}\text{C}$

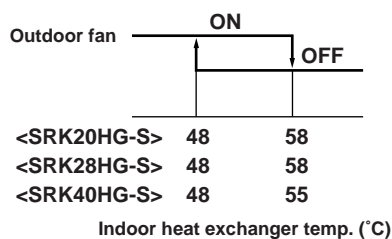

- When the indoor heat exchanger temperature is $\geq 62^{\circ}\text{C}$

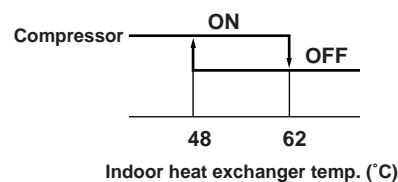

(5) Compressor overheat protection

If the discharge pipe temperature (sensed by Th6) exceeds the set temperature value, the compressor stops. If the temperature is 95°C or lower after a 3-minute delay, it starts again, but if this function is reactivated again within 60 minutes, it results in an abnormal stop.

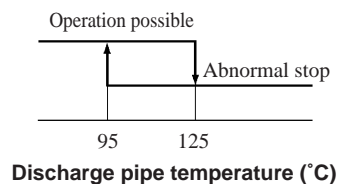

(6) Serial signal transmission error protection

(a) Purpose: Prevents malfunction resulting from error on the indoor ↔ outdoor signals.

(b) Detail of operation: When the indoor unit controller ↔ outdoor unit controller signals cannot be received, the compressor is stopped immediately. Simultaneously, the red LED on the printed circuit board of outdoor unit controller flashing 6 times for 0.5 second at intervals of 8 seconds. Once the operation stops, it does not start any more.

(TIMER light on the indoor unit flashing at the same time.)

(7) Sensor disconnection (room temperature, indoor heat exchanger, outdoor heat exchanger, outdoor air temperature, discharge pipe)

(a) Room temperature sensor

If the temperature detected by the room temperature sensor is -20°C or lower continuously for 15 seconds or longer while operation is stopped, an error indication is displayed.

(b) Indoor heat exchanger sensor

If the temperature detected by the indoor heat exchanger sensor is -20°C or lower continuously for 15 seconds or longer while operation is stopped, an error indication is displayed.

Also, if the temperature detected by the indoor heat exchanger sensor is -20°C or lower continuously for 3 minutes after heating operation has started, the indoor unit's fan speed is forcibly raised to speed 5. After this, the air conditioner is stopped if the detected temperature remains at -20°C continuously for 40 minutes.

(c) Outdoor heat exchanger sensor

If the temperature detected by the outdoor heat exchanger sensor is -50°C or lower continuously for 15 seconds or longer while operation is stopped, an error indication is displayed.

Also, the air conditioner is stopped if the temperature detected by the outdoor heat exchanger sensor remains at -50°C or lower continuously for 40 minutes after heating operation has started.

(d) Outdoor air temperature sensor





If the temperature detected by the outdoor air temperature sensor is -40°C or lower continuously for 15 seconds or longer while operation is stopped, an error indication is displayed.

(e) Discharge pipe sensor

After the compressor has operated for 9 minutes continuously, if there is a disconnected signal for the discharge pipe sensor detected temperature for 15 seconds (less than 7°C), the compressor stops. After a 3-minute delay, it restarts, but if an abnormality is detected 4 times continuously, the air conditioner is stopped fully and an error indication is displayed.

5 APPLICATION DATA



SAFETY PRECAUTIONS

- Please read these “Safety Precautions” first then accurately execute the installation work.
- Though the precautionary points indicated herein are divided under two headings,  and  , those points which are related to the strong possibility of an installation done in error resulting in death or serious injury are listed in the  section. However, there is also a possibility of serious consequences in relationship to the points listed in the  section as well. In either case, important safety related information is indicated, so by all means, properly observe all that is mentioned.
- After completing the installation, along with confirming that no abnormalities were seen from the operation tests, please explain operating methods as well as maintenance methods to the user (customer) of this equipment, based on the owner’s manual. Moreover, ask the customer to keep this sheet together with the owner’s manual.

WARNING

- To disconnect the appliance from the mains supply this appliance must be connected to the mains by means of a circuit breaker or a switch (use a recognized 16A) with a contact separation of at least 3mm.
- The appliance shall be installed in accordance with national wiring regulations.
- When a plug is connected to the power cord, a plug conforming to the IEC60884-1 standard must be used.
- This system should be applied to places as households, residences and the like. Application to inferior environment such as engineering shop could cause equipment malfunction.
- Please entrust installation to either the company which sold you the equipment or to a professional contractor. Defects from improper installations can be the cause of water leakage, electric shocks and fires.
- Execute the installation accurately, based on following the installation manual. Again, improper installations can result in water leakage, electric shocks and fires.
- For installation, confirm that the installation site can sufficiently support heavy weight. When strength is insufficient, injury can result from a falling of the unit.
- For electrical work, please see that a licensed electrician executes the work while following the safety standards related to electrical equipment, and local regulations as well as the installation instructions, and that only exclusive use circuits are used.
Insufficient power source circuit capacity and defective installment execution can be the cause of electric shocks and fires.
- Accurately connect wiring using the proper cable, and insure that the external force of the cable is not conducted to the terminal connection part, through properly securing it. Improper connection or securing can result in heat generation or fire.
- Take care that wiring does not rise upward, and accurately install the lid/service panel. It’s improper installation can also result in heat generation or fire.
- When setting up or moving the location of the air conditioner, do not mix air etc. or anything other than the designated refrigerant (R410A) within the refrigeration cycle.
Rupture and injury caused by abnormal high pressure can result from such mixing.
- Always use accessory parts and authorized parts for installation construction. Using parts not authorized by this company can result in water leakage, electric shock, fire and refrigerant leakage.
- Ventilate the work area when refrigerant leaks during the operation. 
Coming in contact with fire, refrigerant could generate toxic gas.
- Confirm after the foundation construction work that refrigerant does not leak.
If coming in contact with fire of a fan heater, a stove or movable cooking stove, etc., refrigerant leaking in the room could generate toxic gas.
- In joining pipes, do not use conventional (R22) piping flare nuts, etc. The use of conventional piping materials may lead to the rupture of piping due to higher pressure used for the refrigerant cycle and possible personal injury. (Use only piping material designed specifically for R410A)

CAUTION

- Execute proper grounding. Do not connect the ground wire to a gas pipe, water pipe, lightning rod or a telephone ground wire. 
Improper placement of ground wires can result in electric shock.
- The installation of an earth leakage breaker is necessary depending on the established location of the unit. Not installing an earth leakage breaker may result in electric shock.
- Do not install the unit where there is a concern about leakage of combustible gas. 
The rare event of leaked gas collecting around the unit could result in an outbreak of fire.
- For the drain pipe, follow the installation manual to insure that it allows proper drainage and thermally insulate it to prevent condensation. Inadequate plumbing can result in water leakage and water damage to interior items.
- Do not place objects near the outdoor unit or allow leaves to gather around the unit. If there are objects or leaves around the outdoor unit, small animals may enter unit and contact electrical parts resulting in break down, emission of smoke or flame.

5.1 Selection of location for installation

(1) Indoor unit

- Where there is no obstructions to the air flow and where the cooled air can be evenly distributed.
- A solid place where the unit or the wall will not vibrate.
- A place where there will be enough space for servicing.
(Where space mentioned right can be secured)
- Where wiring and the piping work will be easy to conduct.
- The place where receiving part is not exposed to the direct rays of the sun or the strong rays of the street lighting.
- A place where it can be easily drained.
- A place separated at least 1m away from the television or the radio.
(To prevent interference to images and sound.)
- A place that home appliance and household goods, etc. aren't below unit.

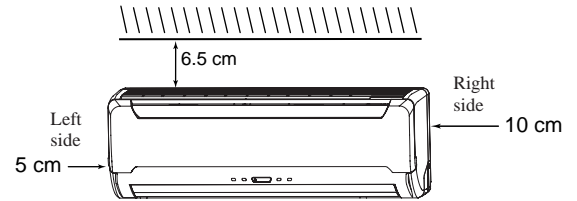

(2) Outdoor unit

- A place where good air circulation can be obtained and where rain, snow or sunshine will not directly strike the unit.
- A place where discharged hot air or unit's operating sound will not be a nuisance to the neighborhood.
- A place where servicing space can be secured.
- A place where vibration will not be enlarged.
- Avoid installing in the following places.
 - A place near the bed room and the like, so that the operation noise will cause no trouble.
 - A place where there is possibility of flammable gas leakage.
 - A place exposed to strong wind.
 - In a salt-laden atmosphere or a place where the generation of oil mist, vapor or fume is expected.

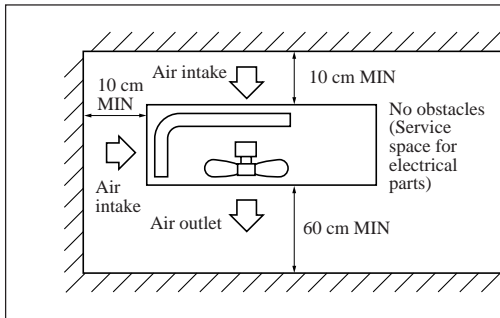

- Notes (1) Blowing out port and suction port on the back side of the unit can be installed at a distance of 10cm from walls.
(In case the barrier is 1.2m or above in height, or is overhead, the sufficient space between the unit and wall shall be secured.)
- (2) When the unit is installed, the space of the following dimension and above shall be secured.

- In heating operation, snow deposit on the heat-exchanger of outdoor unit must be prevented for keeping the normal performance capacity.
 - Snow-hood on outdoor unit as in drawing, will reduce the frequency of defrost operation.
When installing the snow hood, take care so that the air outlet of the snow hood will not face directly into the most windy direction.
 - Design the base higher than possible snow deposit.

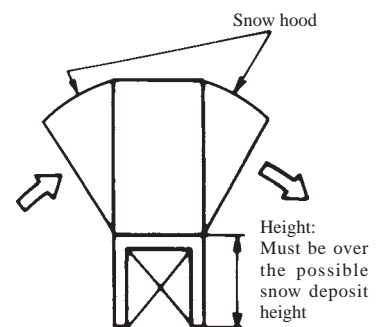

(3) Limitations for one way piping length and vertical height difference.

		Model	All models
Item			
One way piping length (ℓ)			15 m
Vertical height difference (h)	Outdoor unit is lower		10 m
	Outdoor unit is higher		10 m

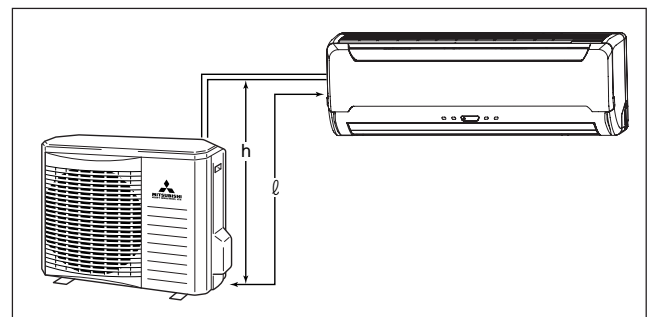

5.2 Installation of indoor unit

(1) Installation of installation board

(a) Fixing of installation board

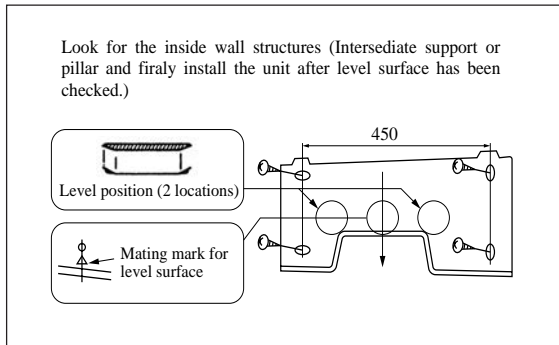

Adjustment of the installation board in the horizontal direction is to be conducted with four screws in a temporary tightened state.

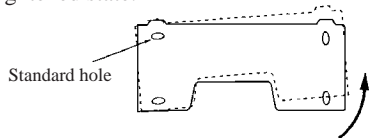

Adjust so that board will be level by turning the board with the standard hole as the center.

Fixing on concrete wall	
Use of nut anchor	Use of bolt anchor
<p>Bolt (M6 x 12)</p> <p>Mounting board</p>	<p>Nut (M6)</p> <p>Mounting board</p> <p>Max. 10</p>

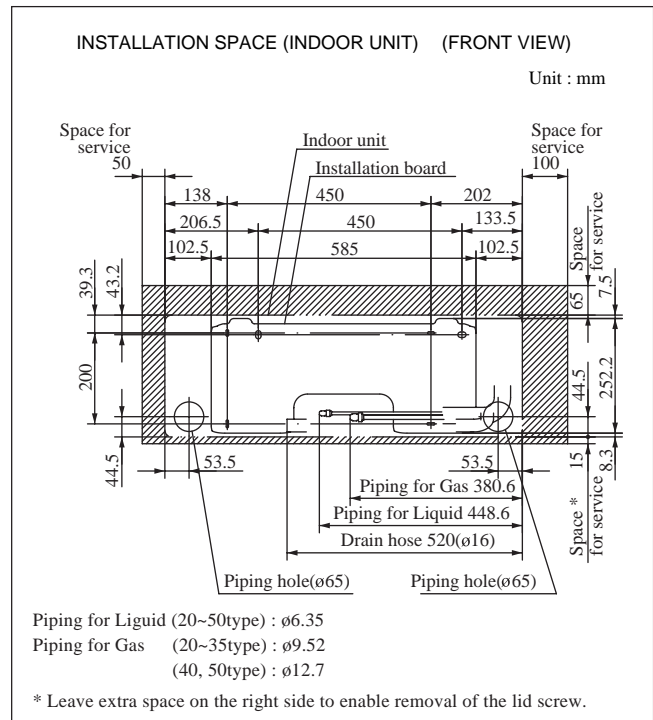

(2) Drilling of holes and fixture sleeve (Option Parts)

When drilling the wall that contains a metal lath, wire lath or metal plate, be sure to use pipe hole sleeve sold separately.

(a) Drill a hole with ø65 whole core drill

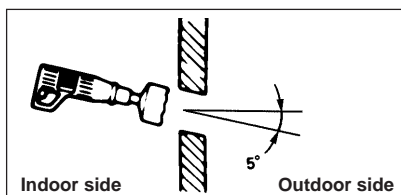

Note (1) Drill a hole with incline of 5 degree from indoor side to outdoor side.

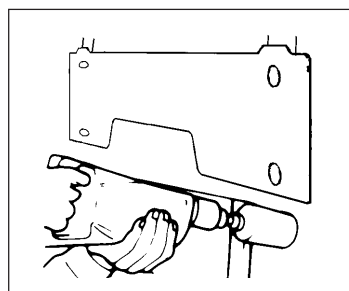

(b) Adjusting sleeve length

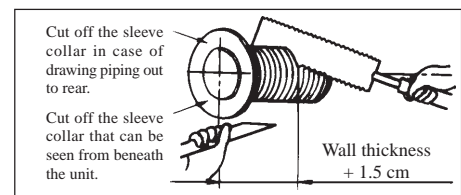

(c) Install the sleeve

(Inserting sleeve)

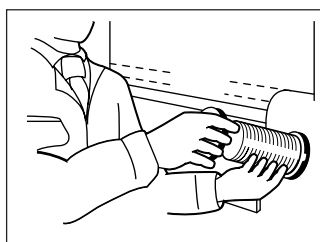

(*Sleeve + *Inclined + *Sealing plate)

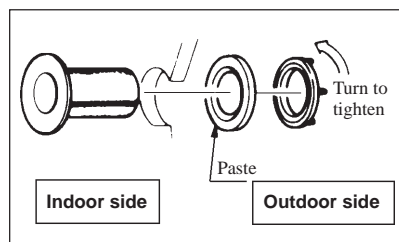

View of sleeve when installed

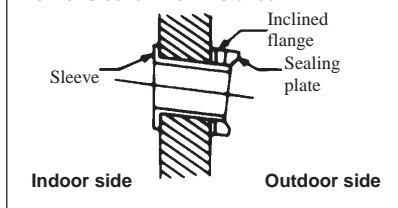

(3) Preparation of indoor unit

(a) Mounting of connecting wires

- 1) Remove the lid(R).
- 2) Remove the wiring clamp.
- 3) Connect the connecting wire securely to the terminal block.

Use cables for interconnection wiring to avoid loosening of the wires.
 CENELEC code for cables. Required field cables.
 H05RNR4G1.5 (Example) or 245IEC57

H Harmonized cable type
 05 300/500 volts
 R Natural-and/or synth, rubber wire insulation
 N Polychloroprene rubber conductors insulation
 R Standed core
 4or5 Number of conductors
 G One conductor of the cable is the earth conductor (yellow/green)
 1.5 Section of copper wire (mm²)

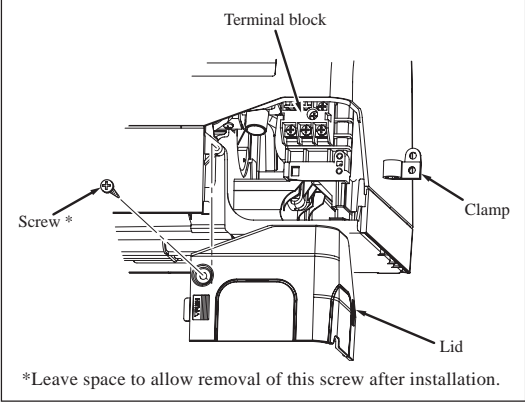

- ① Connect the connection wire securely to the terminal block. If the wire is not affixed completely, contact will be poor, and it is dangerous as the terminal block may heat up and catch fire.
- ② Take care not to confuse the terminal numbers for indoor and outdoor connections.
- ③ Affix the connection wire using the wiring clamp.
- 4) Fix the connecting wire by wiring clamp.
- 5) Attach the lid.

(b) Installing the support of piping

[Shaping the piping]

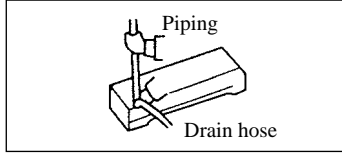

- Hold the bottom of the piping and fix direction before stretching it and shaping it.

[Taping of the exterior]

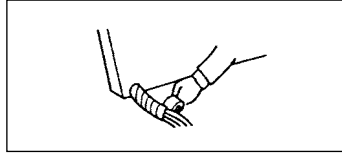

- Tape only the portion that goes through the wall. Always tape the crossover wiring with the piping.

[Matters of special notice when piping from left or center/rear of the unit.]

[Top View]

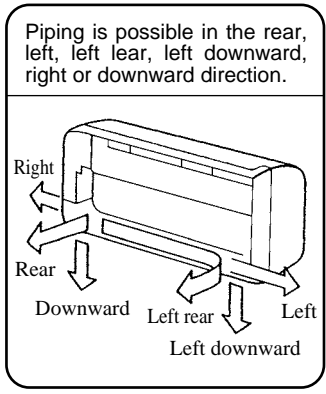
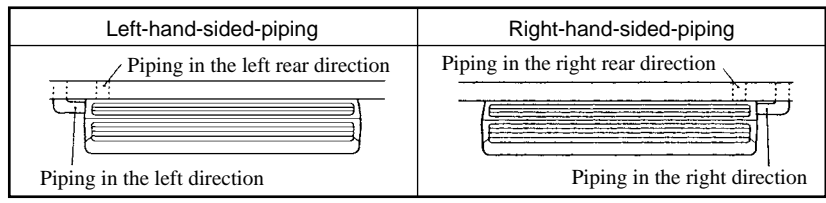

[Drain hose changing procedures]

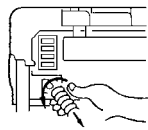
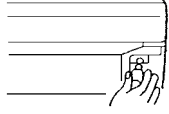
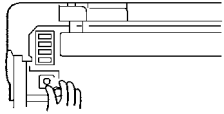
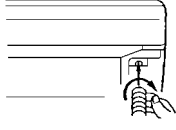
1. Remove the drain hose.	2. Remove the drain cap.	3. Insert the drain cap.	4. Connect the drain hose.
			

- Remove the drain hose, making it rotate.
- Remove it with hand or pliers.
- Insert the drain cap which was removed at procedure "2" securely using a hexagonal wrench, etc.
Note: Be careful that if it is not inserted securely, water leakage may occur.
- Insert the drain hose securely, making it rotate.
Note: Be careful that if it is not inserted securely, water leakage may occur.

Since this air conditioner has been designed to collect dew drops on the rear surface to the drain pan, do not attach the power cord above the gutter.

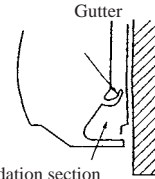

Pipe accommodation section

Drainage

- Arrange the drain hose in a downward angle.
- Avoid the following drain piping.

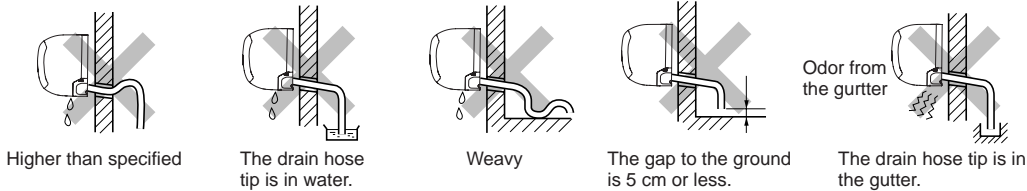

- Pour water to the drain pan located under the heat exchanger, and ensure that the water is discharged outdoor.
- When the extended drain hose is indoor, always use a shield pipe (to be arranged by the user) and ensure it is thermally insulated.

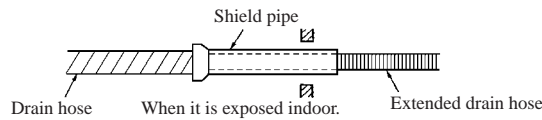

(c) Fixing of indoor unit

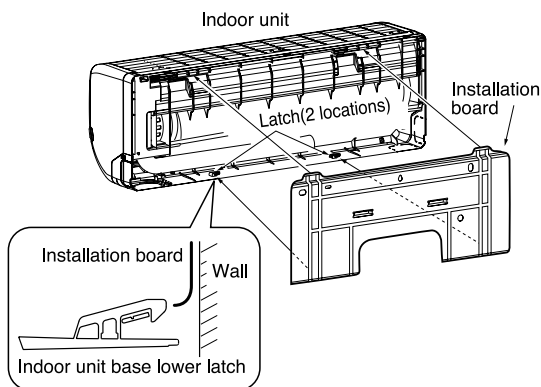

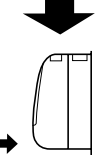
Installation Steps	
① Pass the pipe through the hole in the wall, and hook the upper part of the indoor unit to the installation board.	
② Gently push the lower part to secure the unit.	

- How to remove the indoor unit from the installation board
 - ① Push up at the marked portion of the indoor unit base lower latch, and slightly pull it toward you. (both right and left hand sides)
(The indoor unit base lower latch can be removed from the installation board)
 - ② Push up the indoor unit upward. So the indoor unit will be removed from the installation board.

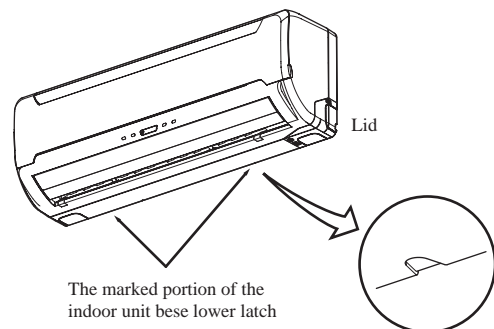

5.3 Installation of outdoor unit

(1) Installation of outdoor unit

- Make sure that the unit is stable in installation. Fix the unit to stable base.
- When installing the unit at a higher place or where it could be toppled by strong winds, secure the unit firmly with foundation bolts, wire, etc.
- Perform wiring, making wire terminal numbers conform to terminal numbers of indoor unit terminal block.
- Connect using ground screw located near \oplus mark.
- In areas where the temperatures drop below 0°C for several continuous days, do not install a drain elbow.
(Water discharge could stop due to freezing.)

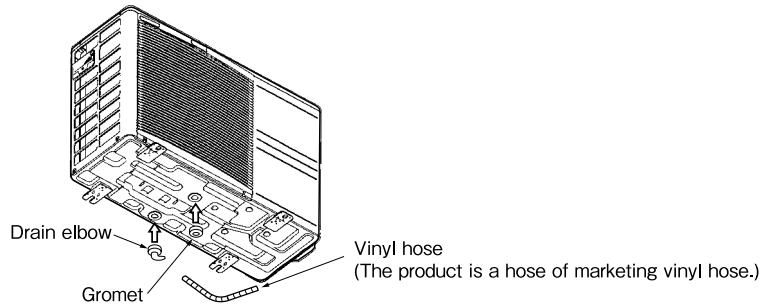

5.4 Connection of refrigerant pipings

(1) Preparation

Keep the openings of the pipes covered with tapes etc. to prevent dust, sand, etc. from entering them.

(a) Indoor unit side

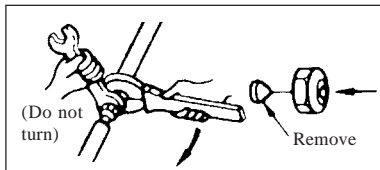

- Remove the flared nuts.
(on both liquid and gas sides)

(b) Outdoor unit side

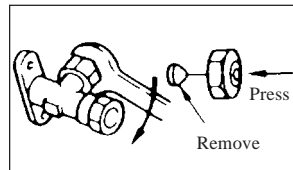

- Remove the flared nuts.
(on both liquid and gas sides)

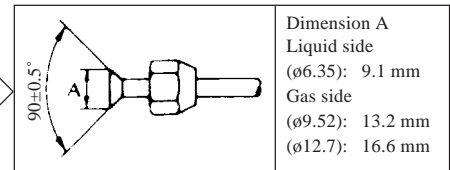

- Install the removed flared nuts to the pipes to be connected, then flare the pipes.

Dimension A
Liquid side (ø6.35): 9.1 mm
Gas side (ø9.52): 13.2 mm
(ø12.7): 16.6 mm

(2) Connection of refrigerant piping

(a) Indoor unit side

- Connect firmly gas and liquid side pipings by Torque wrench.

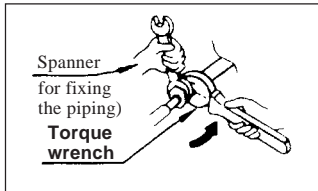

- Specified torquing value:
Liquid side (ø6.35) : 14~18N·m (1.4~1.8kgf·m)
Gas side (ø9.52) : 34~42N·m (3.4~4.2kgf·m)
Gas side (ø12.7) : 49~61N·m (4.9~6.1kgf·m)

(b) Outdoor unit side

- Connect firmly gas and liquid side pipings by Torque wrench.

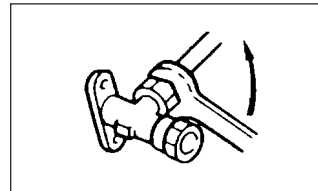

- Specified torquing value:
Liquid side (ø6.35) : 14~18N·m (1.4~1.8kgf·m)
Gas side (ø9.52) : 34~42N·m (3.4~4.2kgf·m)
Gas side (ø12.7) : 49~61N·m (4.9~6.1kgf·m)
- Use one more spanner to fix the valve.
- Always use a Torque wrench and back up spanner to tighten the flare nut.

(3) Air purge

- (a) Tighten all flare nuts in the pipings both indoor and outside will so as not to cause leak.
- (b) Connect service valve, charge hose, manifold valve and vacuum pump as is illustrated below.
- (c) Open manifold valve handle Lo to its full width, and perform vacuum or evacuation.
Continue the vacuum or evacuation operation for 15 minutes or more and check to see that the vacuum gauge reads -0.1 MPa (-76 cmHg).
- (d) After completing vacuum operation, fully open service valve (Both gas and liquid sides) with hexagon headed wrench.
- (e) Detach the charge hoses.
- (f) Check for possible leakage of gas in the connection parts of both indoor and outdoor.

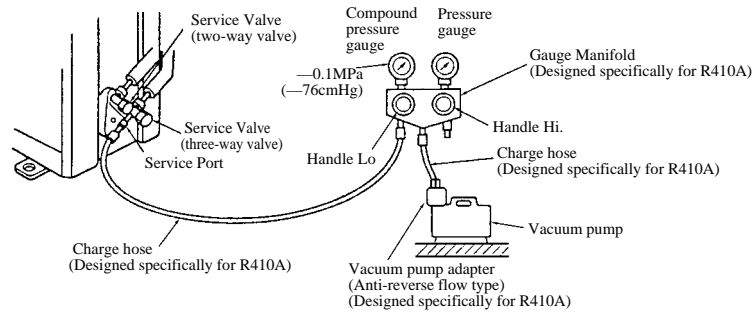

- Since the system uses service ports differing in diameter from those found on the conventional models, a charge hose (for R22) presently in use is not applicable.
Please use one designed specifically for R410A
- Please use an anti-reverse flow type vacuum pump adapter so as to prevent vacuum pump oil from running back into the system.
Oil running back into an air-conditioning system may cause the refrigerant cycle to break down.

Additional refrigerant charge

Additional refrigerant charge is not required at all.

(4) Insulation of connecting portion

- (a) Cover the connecting portion of the refrigerant piping with the pipe cover and seal them.
If neglecting to do so, moisture occurs on the piping and water will drip out.

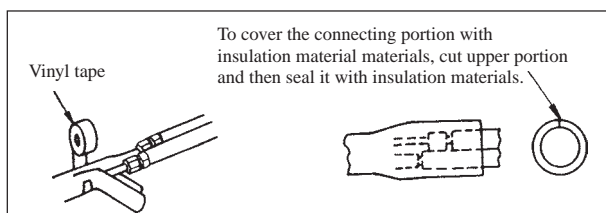

- (b) Finishing and fixing
 - 1) Tie up the piping with wrapping tape, and shape it so that it conforms to which the pipe is attached.
 - 2) Fix them with clamps as right figure.

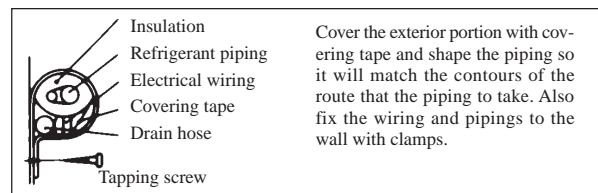

5.5 Test run

- (1) Conduct trial run after confirming that there is no gas leaks.
- (2) When conducting trial run set the remote control thermostat to continuous operation position. However when the power source is cut off or when the unit's operation switch is turned off or was turned to fan operation position, the unit will not go into operation in order to protect the compressor.
- (3) Explain to the customer on the correct usage of the air conditioner in simple layman's terms.
- (4) Make sure that drain flows properly.
- (5) **Standard operation data** (220/230/240V)

Item	Model	SRK20HG-S	SRK28HG-S	SRK40HG-S
	High pressure (MPa)	Cooling	–	–
Heating		2.35~2.55	2.35~2.55	2.65~2.84
Low pressure (MPa)	Cooling	0.88~1.08	0.88~1.08	0.78~0.98
	Heating	–	–	–
Temp. difference between return air and supply air (°C)	Cooling	12~14	12~14	13~15
	Heating	14~16	14~16	19~21
Running current (A)	Cooling	3.1/3.0/2.9	3.8/3.7/3.6	5.3/5.2/5.1
	Heating	3.0/2.9/2.8	3.7/3.5/3.3	5.4/5.3/5.2

Note (1) The data are measured at following conditions

Ambient air temperature

Indoor side: Cooling ... 27°C DB, 19°C WB, Heating ... 20°C DB

Outdoor side: Cooling ... 35°C DB, 24°C WB, Heating ... 7°C DB, 6°C WB

5.6 Precautions for wireless remote control installation and operation

- (1) **Wireless remote control covers the following distances:**
 - (a) **When operating facing the air conditioner:**

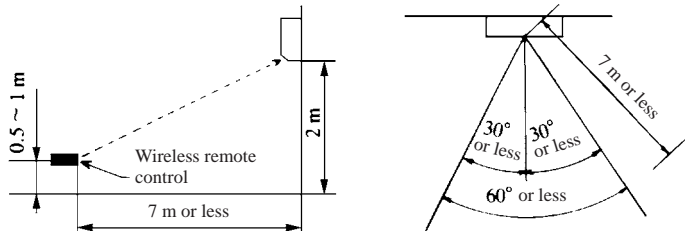

If the distances exceed the area indicated above, be sure to check the receiver status.

- (b) **When manipulating the remote control mounted on a wall:**

Make sure that it works normally (i.e., transmission/reception signal is audible) before mounting.

- Notes (1) The remote control is correctly facing the sensing element of the air conditioner when being manipulated.
- (2) The typical coverage is indicated (in the left illustration). It may be more or less depending on the installation.
- (3) The coverage may be less or even nil. If the sensing element is exposed to strong light, such as direct sunlight, illumination, etc., or dust is deposited on it or it is used behind a curtain, etc.

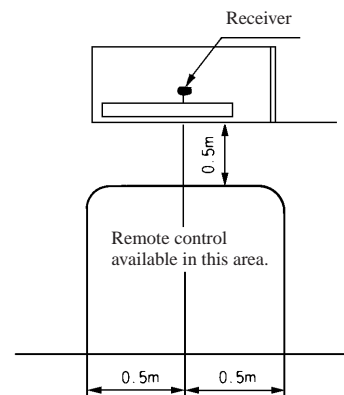

6 MAINTENANCE DATA

6.1 Trouble shooting

(1) Trouble shooting to be performed prior to exchanging PCB, (Printed circuit board) [Common to all models]

All the models described in this chapter are controlled by a microcomputer. When providing maintenance service to customers it is necessary to understand the function controlled by a microcomputer thoroughly, so as not to mistakenly identify correct operations as mis-operations. It is also necessary to perform the following simple checks before conducting detailed checks or exchanging printed circuit board.

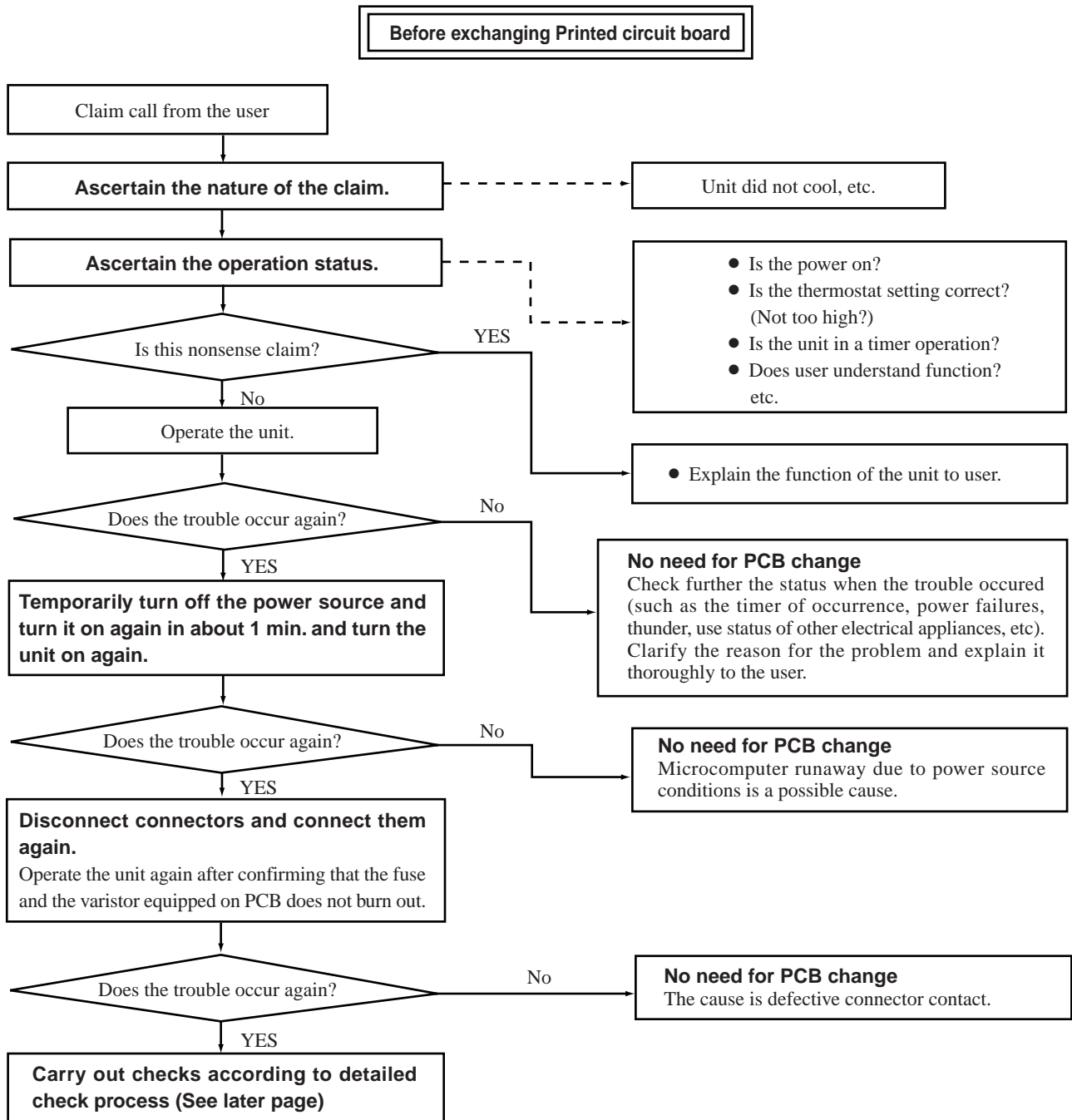

(2) Self diagnosis display on indoor unit

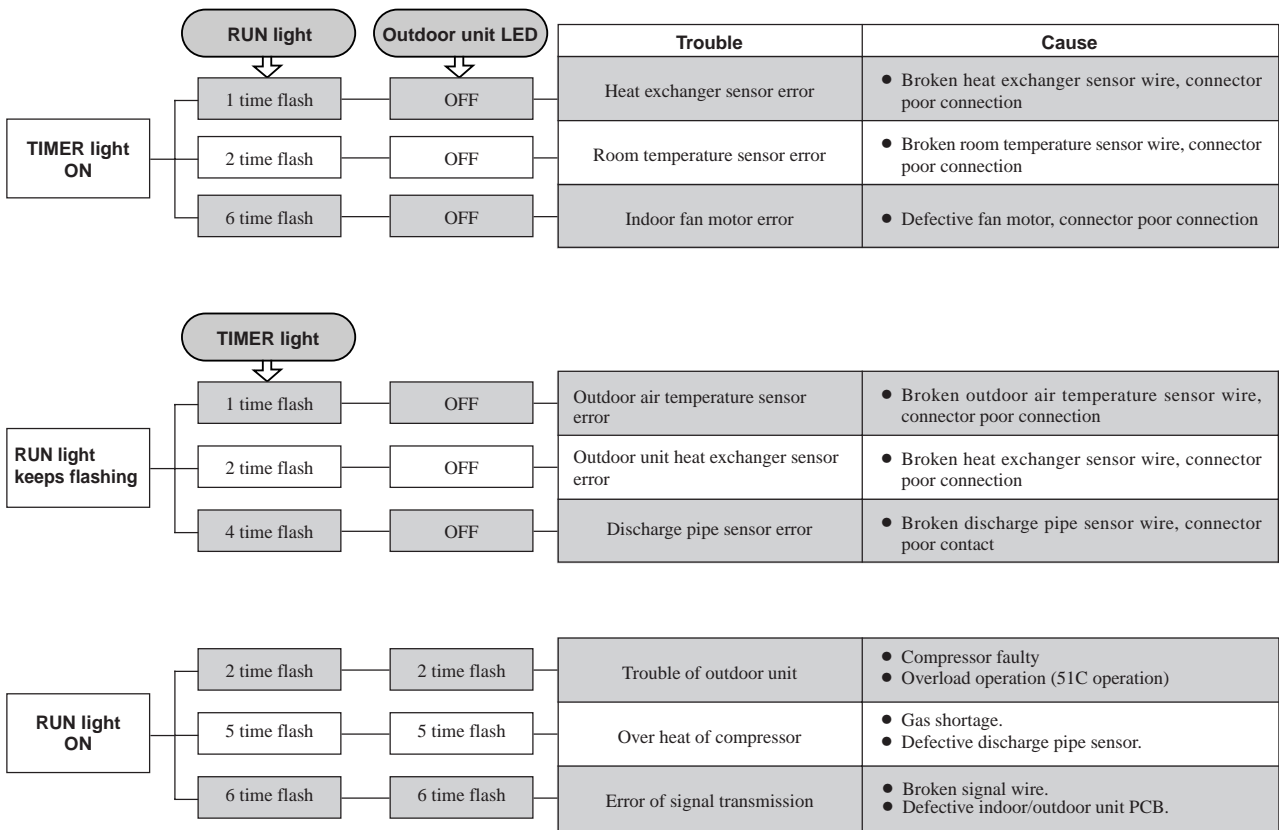

(3) Inspection procedures corresponding to detail of trouble

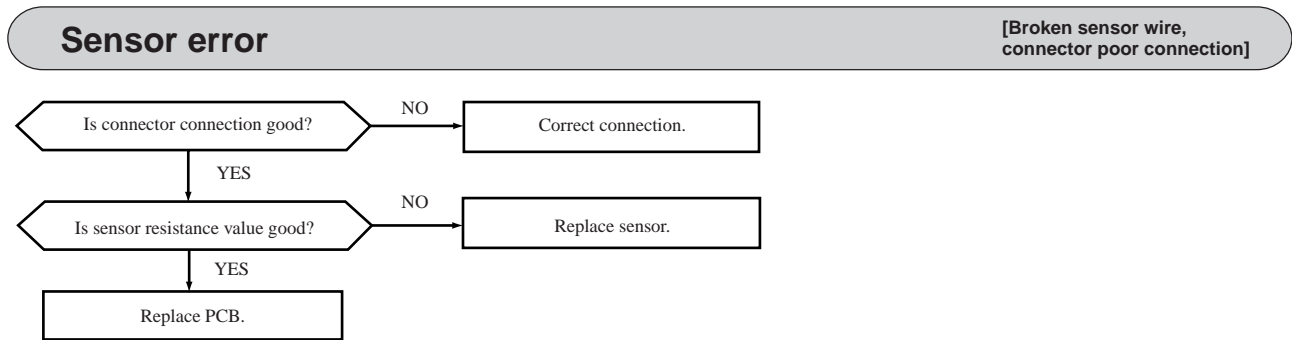

◆ Discharge pipe sensor temperature characteristics

Temperature (°C)	Resistance (kΩ)	Temperature (°C)	Resistance (kΩ)
0	164	70	8.7
5	127	75	7.3
10	99	80	6.2
15	78	85	5.3
20	62	90	4.5
25	50	95	3.9
30	40	100	3.3
35	32	105	2.9
40	26	110	2.5
45	21	115	2.2
50	17	120	1.9
55	14	125	1.6
60	12	130	1.4
65	10	135	1.3

◆ Sensor temperature characteristics (Room temp., indoor unit heat exchanger temp., outdoor unit heat exchanger temp., outdoor air temp.)

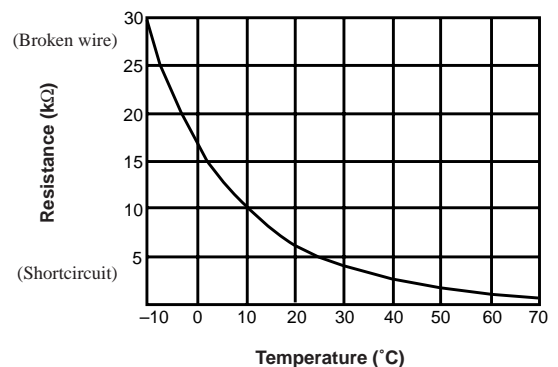

Trouble of outdoor unit

[Compressor faulty, compressor wiring disconnected.]

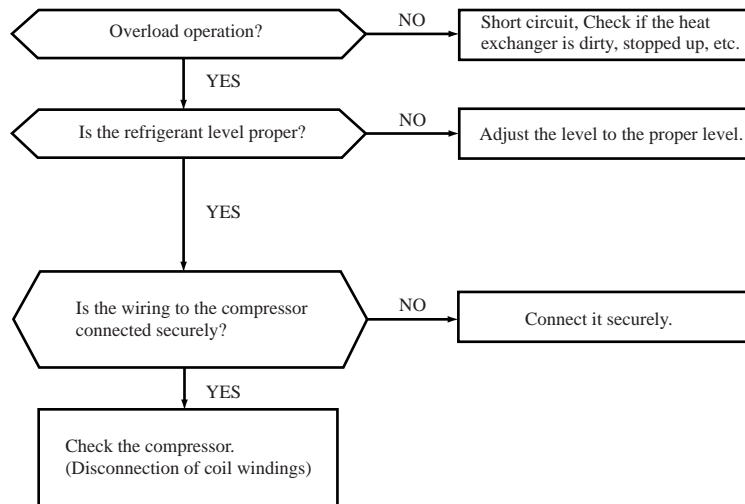

Over heat of compressor

[Gas shortage, defective discharge pipe sensor]

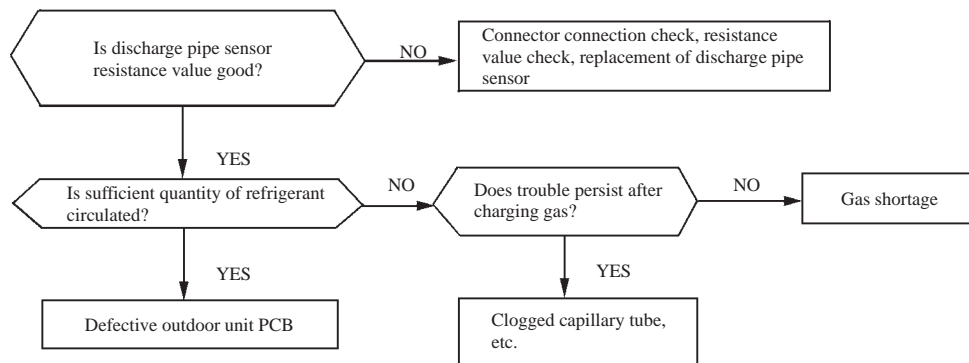

Indoor fan motor error

[Defective fan motor, defective PCB]

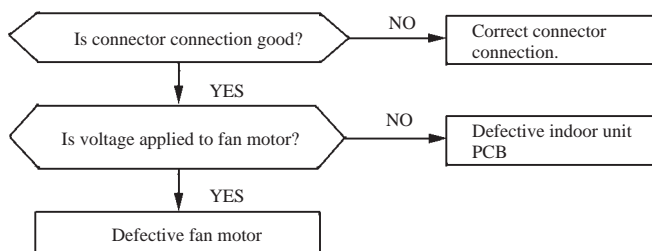

Error of signal transmission

[Wiring error including power cable, defective indoor/
outdoor unit PCB]

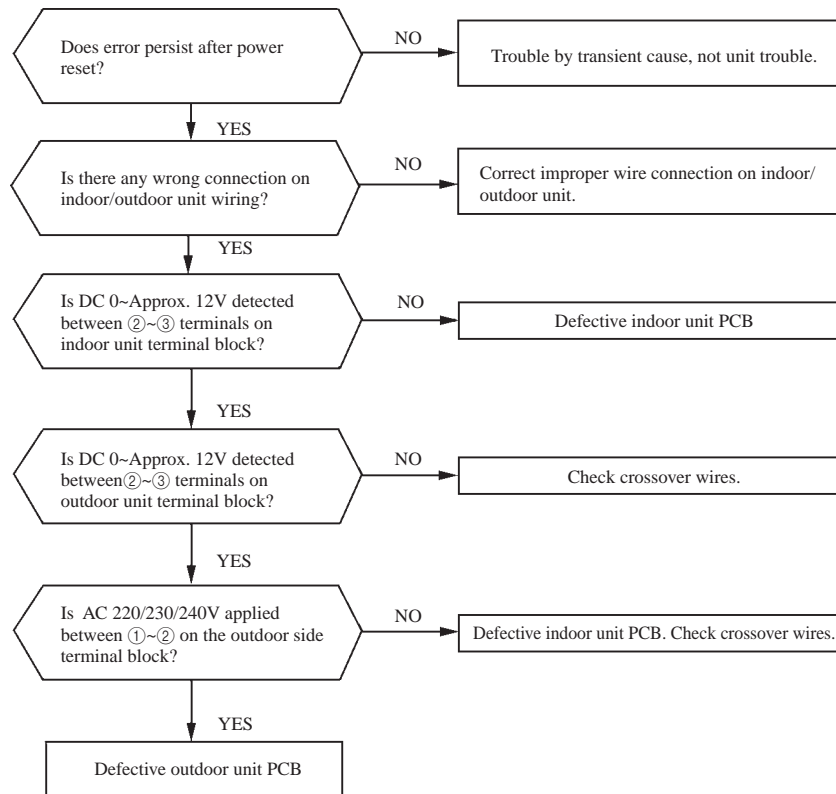

(4) Phenomenon observed after shortcircuit, wire breakage on sensor.

(a) Indoor unit

Sensor	Operation mode	Phenomenon	
		Shortcircuit	Broken wire
Room temperature sensor	Cooling	Release of continuous compressor operation command	Continuous compressor operation command is not released.
	Heating	Continuous compressor operation command is not released.	Release of continuous compressor operation command
Heat exchanger sensor	Cooling	System can be operated normally.	Continuous compressor operation command is not released. (Anti-frosting)
	Heating	High pressure control mode	Hot keep (Indoor fan stop)

(b) Outdoor unit

sensor	Operation mode	Phenomenon	
		Shortcircuit	Broken wire
Heat exchanger sensor	Cooling	System can be operated normally.	System can be operated normally.
	Heating	Defrosting is not performed.	Defrosting is performed for 10 minutes at approx. 50 minutes.
Outdoor air temperature sensor	Cooling	System can be operated normally.	System can be operated normally.
	Heating	Defrosting is not operated.	Defrosting is performed for 10 minutes at approx. 50 minutes.
Discharge pipe sensor	All modes	Compressor overload protection is disabled. (Can be operated.)	Compressor stop

(5) Inspection procedures of indoor electrical equipment

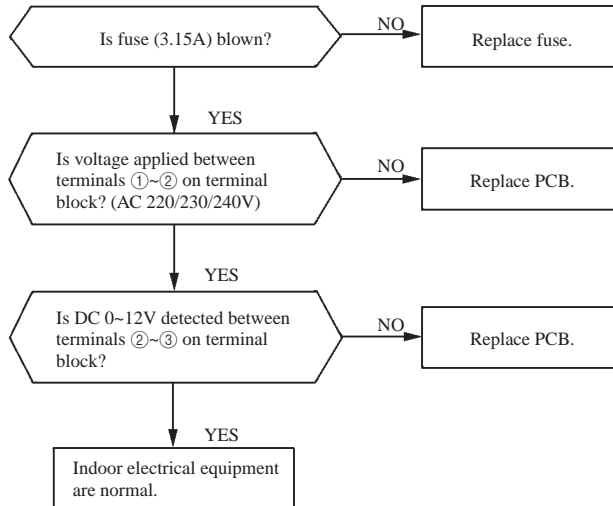

Notes (1) Since the communication timing signal is transmitted only when the 52C is turned ON, check it under the operating condition.

(2) Check the voltage on the terminal block.

- Power supply: Between ①~② (AC 220/230/240V)
- Signal: Between ②~③ (Changing between DC 0~Approx. 12V)

(6) How to make sure of remote control

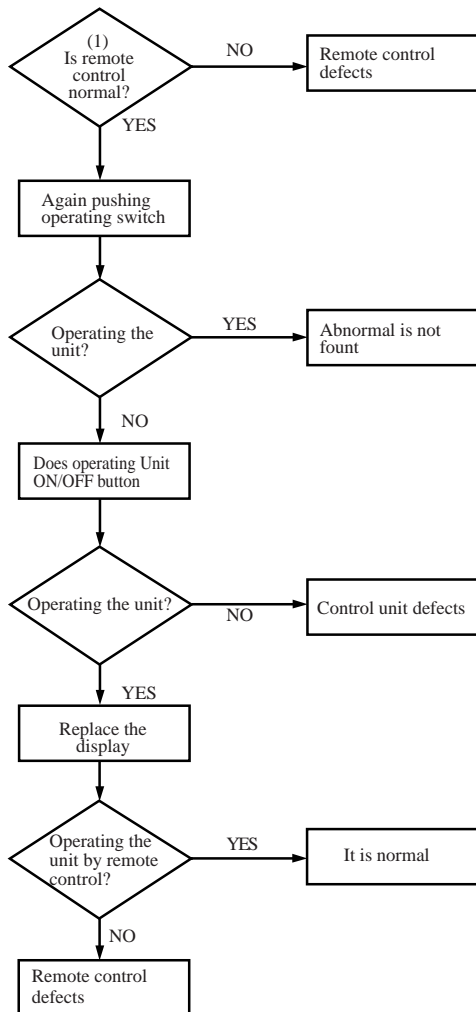

Note (1) How to check the remote control.

(a) Press the reset switch of remote control.

(b) If the almost normal if entire display of remote control is shown after / indication.

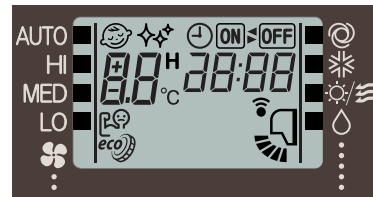

6.2 Servicing

(1) Evacuation

The evacuation is an procedure to purge impurities.....noncondensable gas, air, moisture from the refrigerant equipment by using a vacuum pump. Since the refrigerant R410A is very insoluble in water, even a small amount of moisture left in the refrigerant equipment will freeze, causing what is called water clogging.

- Evacuation procedure

- Check to ensure that there is no internal pressure in the unit. If there is an internal pressure, it should be relieved through the check joint.
- Connect the service hoses of the gauge manifold to the check joint of the gas & liquid piping.
- Connect a vacuum pump to the charge hose (A) . Repeat evacuation in the following sequence.

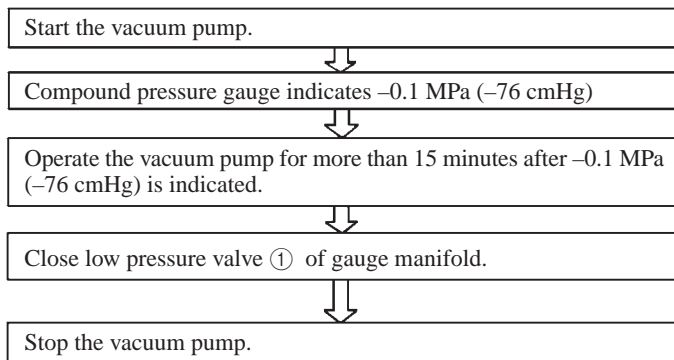

- Notes
- (1) Do not use the refrigerant pressure to expel air.
 - (2) Do not use the compressor for evacuation.
 - (3) Do not operate the compressor in the vacuum condition.

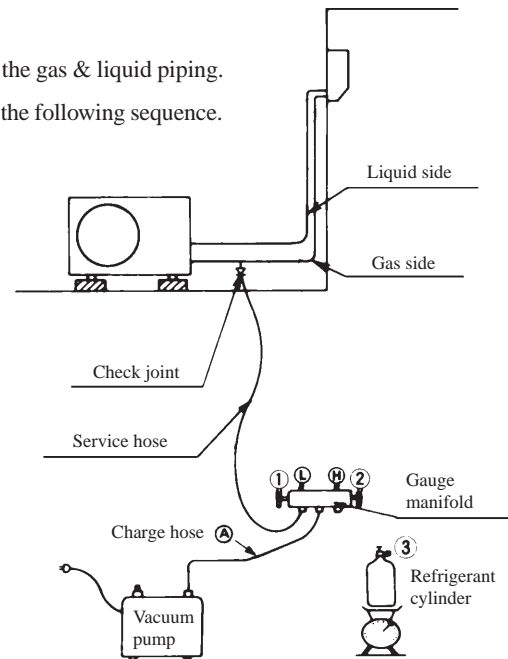

(2) Refrigerant charge

- Discharge refrigerant entirely from the unit and evacuate the unit.

Note: Addition of refrigerant without evacuation is unreasonable, because it will result in low charge or overcharge.
- Keep the gauge manifold and connect a refrigerant cylinder to the unit.
- Record the weight of the refrigerant cylinder on the balance. This is necessary for making sure of the charged refrigerant amount.
- Purge air from the charge hose (A)

Firstly loose the connecting portion of the charge hose (A) at the gauge manifold side and open the valve (3) for a few seconds, and then immediately retighten it after observing that gas is blow out from the loosened portion.
- Open the valve (1) and (3) after discharging air from the charge hose (A), then the liquid refrigerant begins flowing from the cylinder into the unit. Be sure to erect the refrigerant cylinder upright to let liquid refrigerant flow into the unit.
- When refrigerant has been charged into the system to some extent, refrigerant flow becomes stagnant, when that happens, start the compressor in cooling cycle until the unit is filled with refrigerant to the specified weight.
- Making sure of the refrigerant amount, close the valve (3)
- Disconnect the charge hose from the unit. Cover the valve ports of the refrigerant piping with caps and tighten them securely.
- Check for gas leakage applying a gas leak detector along the piping line.
- Start the air conditioner and make sure of its operating condition.....high side and low side pressures and temperature difference between return air and supply air.

7 REFRIGERANT PIPING INSTALLATION/SERVICING MANUAL FOR AIR CONDITIONERS USING R410A

(These materials are extracted from document issued by The Japan Refrigeration and Air Conditioning Industry Association)

7.1 Outline

7.1.1 Refrigerant R410A

(1) Adoption of R410A in air conditioners

In 1974, it was pointed out that the ozone layer in the upper stratosphere (about 20 ~ 40 km above ground) might have been damaged by the ozone depleting substances such as CFC (chlorofluorocarbon) and HCFC (hydrochlorofluorocarbon). Since that time, many countries across the world have endeavored to take countermeasures against the ozone depletion.

As a refrigerant belonging to the HCFCs, the conventional refrigerant (R22) used in air conditioners also tends to deplete the ozone layer. Therefore, complying with the provisions of the international regulations (i.e. Montreal Protocol concerning the Ozone Depleting Substances) and national laws & Regulations concerned, it is necessary to replace R22 with other types of refrigerant which do not deplete the ozone layer.

A refrigerant composed of hydrogen (H), fluorine (F) and carbon (C), is called an HFC and does not deplete the ozone layer. One HFC's is R410A whose pressure is about 1.6 times higher than R22 and whose energy efficiency is almost comparable to that of R22 at the same refrigerant temperature.

(2) Chemical characteristics of R410A

a) Chemical stability

Like R22, R410A is a chemically stable, less toxic and non-flammable refrigerant. However, as in the case of R22, the specific gravity of its vapour is larger than that of air and should it leak in an airtight room it may stay at a low level and cause an oxygen starvation accident. It may also, should it come in direct contact with fire, cause a poisonous gas to occur, so be sure to handle it only in a well ventilated area.

b) Composition changes (Pseudo-azeotropic characteristics)

R410A is a pseudo-azeotropic mixed refrigerant composed of two constituents - R32 and R125. "Quasi-azeotropic" condition refers to a state in which the dew-point curve and boiling-point curve - gas-liquid equilibrium curves (pressure constant) - almost lie on top of each other, and a multi-constituent refrigerant having this chemical characteristic incurs less composition changes even when evaporation (or condensation) as a phase change occurs. Consequently, even when refrigerant leaks from the gas phase somewhere in the piping installation, the composition of circulated refrigerant incurs less changes.

Therefore, R410A can be treated in almost a same manner as a mono-constituent refrigerant like R22 is treated. When actually charging R410A, however, do so from the liquid phase side by taking into account the phenomenon that, when put in a cylinder, the composition changes a little between gas and liquid phases.

c) Pressure characteristics

As shown in Table 2, since R410A's vapor pressure is about 1.6 times higher than that of R22 at the same temperature, perform installation/service with special tools and materials which are exclusive for R410A and can withstand high pressure.

Table 1. Comparison of thermophysical properties of R410A and R22

	R410A	R22
Composition (wt%)	R32/R125 (50/50)	R22 (100)
Molecular weight	72.6	86.5
Boiling point (°C)	-51.4	-40.8
Vapor pressure (25°C, MPa)	1.56	0.94
Saturated vapor density (25°C, kg/m ³)	64.0	44.4
Inflammability	Nonflammable	Nonflammable
Ozone depletion potential (ODP)	0	0.055
Global warming potential (GWP)	1730	1700

Source: List of thermophysical properties compiled by the Japan society of refrigeration and air conditioning, NIST REFPROP V5.10, etc.

Table 2. Comparison of saturated vapor pressure of R410A and R22
unit: MPa

Refrigerant Temperature (°C)	R410A	R22
-20	0.30	0.14
0	0.70	0.40
20	1.35	0.81
40	2.32	1.43
60	3.73	2.33
65	4.15	2.60

Source: List of thermophysical properties compiled by the Japan society of refrigeration and air conditioning, NIST REFPROP V5.10, etc.

(3) Lubricating oils for R410A

As the lubricating oils for R22, mineral oils, alkylbenze synthetic oils, etc. have so far been used. As R410A features less solubility with these conventional lubricating oils such as mineral oils, the lubricating oils tend to stay within the refrigeration cycle. As the lubricating oils highly soluble with R410A, ester, ethereal and other synthetic oils are available. However, as these synthetic oils are very hygroscopic, they must be treated even more carefully than the conventional lubricating oils. Furthermore, if these synthetic oils are mixed with mineral oils, alkylbenzene synthetic oils, etc., they may deteriorate, and block the capillary tubes, or cause the compressor to fail. So, never mix these synthetic oils.

7.1.2 Safety during installation/servicing

As R410A’s pressure is about 1.6 times higher than that of R22, improper installation/servicing may cause a serious trouble. By using tools and materials exclusive for R410A, it is necessary to carry out installation/servicing safely while taking the following precautions into consideration.

- 1) Never use refrigerant other than R410A in an air conditioner which is designed to operate with R410A.
- 2) If a refrigeration gas leakage occurs during installation/servicing, be sure to ventilate fully.
If the refrigerant gas comes into contact with fire, a poisonous gas may occur.
- 3) When installing or removing an air conditioner, do not allow air or moisture to remain in the refrigeration cycle. Otherwise, pressure in the refrigeration cycle may become abnormally high so that a rupture or personal injury may be caused.
- 4) After completion of installation work, check to make sure that there is no refrigeration gas leakage.
If the refrigerant gas leaks into the room, coming into contact with fire in the fan driven heater, space heater, etc., a poisonous gas may occur.
- 5) When an air conditioning system charged with a large volume of refrigerant (e.g. multi type air conditioner) is installed in a small room, it is necessary to exercise care so that, even when refrigerant leaks, its concentration does not exceed the marginal level.
If the refrigerant gas leakage occurs and its concentration exceeds the marginal level, an oxygen starvation accident may result.
- 6) Be sure to carry out installation or removal according to the installation manual.
Improper installation may cause refrigeration trouble, water leakage, electric shock, fire, etc.
- 7) Unauthorized modifications to the air conditioner may be dangerous. If a breakdown occurs please call a qualified air conditioner technician or electrician.
Improper repair’s may result in water leakage, electric shock and fire, etc.

7.2 Refrigerant piping installation

7.2.1 Piping materials and joints used

For the refrigerant piping installation, copper pipes and joints are mainly used. Copper pipes and joints suitable for the refrigerant must be chosen and installed. Furthermore, it is necessary to use clean copper pipes and joints whose interior surfaces are less affected by contaminants.

(1) Copper pipes

It is necessary to use seamless copper pipes which are made of either copper or copper alloy and it is desirable that the amount of residual oil is less than 40 mg/10m. Do not use copper pipes having a collapsed, deformed or discolored portion (especially on the interior surface). Otherwise, the expansion valve or capillary tube may become blocked with contaminants.

As an air conditioner using R410A incurs pressure higher than when using R22, it is necessary to choose adequate materials. Thicknesses of copper pipes used with R410A are as shown in Table 3. Never use copper pipes thinner than 0.8 mm even when it is available on the market.

Table 3. Thicknesses of annealed copper pipes

Nominal diameter	Outer diameter (mm)	Thickness (mm)	
		R410A	[ref.] R22
1/4	6.35	0.80	0.80
3/8	9.52	0.80	0.80
1/2	12.70	0.80	0.80
5/8	15.88	1.00	1.00

(2) Joints

For copper pipes, flare joints or socket joints are used. Prior to use, be sure to remove all contaminants.

a) Flare joints

Flare joints used to connect the copper pipes cannot be used for pipings whose outer diameter exceeds 20 mm. In such a case, socket joints can be used.

Sizes of flare pipe ends, flare joint ends and flare nuts are as shown in Tables 5~8 (see on page 39, 40) below. Also, union, half union, Tee-type union and elbow-type union shapes are generally used (see Fig 1).

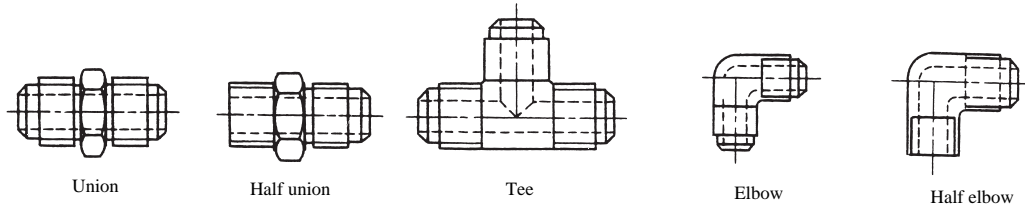

Fig.1 Flare joints

b) Socket joints

Socket joints are such that they are brazed for connections, and used mainly for thick pipings whose diameter is larger than 20 mm.

Thicknesses of socket joints are as shown in Table 4. Socket, elbow-type and tee-type shapes are generally used (see Fig. 2).

Table 4. Minimum thicknesses of socket joints

Nominal diameter	Reference outer diameter of copper pipe jointed (mm)	Minimum joint thickness (mm)
1/4	6.35	0.50
3/8	9.52	0.60
1/2	12.70	0.70
5/8	15.88	0.80

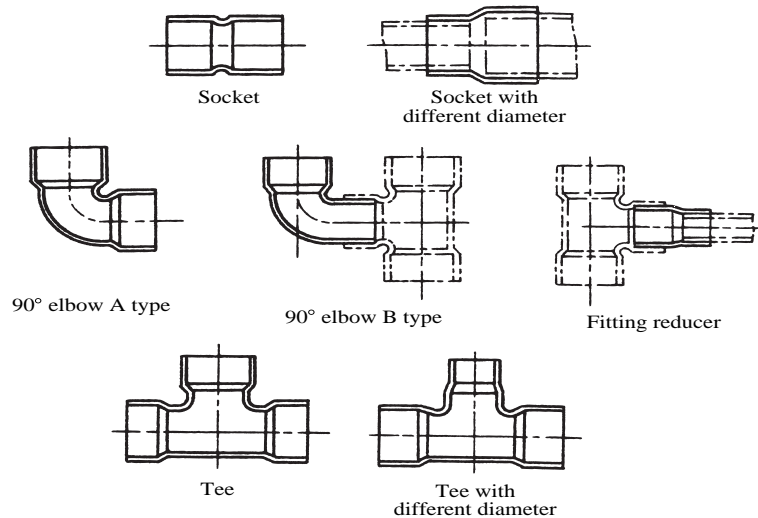

Fig.2 Socket joints

7.2.2 Processing of piping materials

When performing the refrigerant piping installation, care should be taken to ensure that water or dust does not enter the pipe interior, that no other oil other than lubricating oils used in the installed air conditioner is used, and that refrigerant does not leak. When using lubricating oils in the piping processing, use such lubricating oils whose water content has been removed. When stored, be sure to seal the container with an airtight cap or any other cover.

(1) Flare processing procedures and precautions

a) Cutting the pipe

By means of a pipe cutter, slowly cut the pipe so that it is not deformed.

b) Removing burrs and chips

If the flared section has chips or burrs, refrigerant leakage may occur. Carefully remove all burrs and clean the cut surface before installation.

c) Insertion of flare nut

d) Flare processing

Make certain that a clamp bar and copper pipe have been cleaned.

By means of the clamp bar, perform the flare processing correctly.

Use either a flare tool for R410A or conventional flare tool.

Flare processing dimensions differ according to the type of flare tool. Be careful. When using a conventional flare tool, be sure to secure “dimension A” by using a gage for size adjustment.

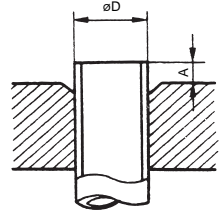

Fig.3 Flare processing dimensions

Table 5. Dimensions related to flare processing for R410A

Nominal diameter	Outer diameter (mm)	Thickness (mm)	A (mm)		
			Flare tool for R410A Clutch type	Conventional flare tool	
				Clutch type	Wing nut type
1/4	6.35	0.8	0~0.5	1.0~1.5	1.5~2.0
3/8	9.52	0.8	0~0.5	1.0~1.5	1.5~2.0
1/2	12.70	0.8	0~0.5	1.0~1.5	2.0~2.5
5/8	15.88	1.0	0~0.5	1.0~1.5	2.0~2.5

Table 6. Dimensions related to flare processing for R22

Nominal diameter	Outer diameter (mm)	Thickness (mm)	A (mm)		
			Flare tool for R410A Clutch type	Conventional flare tool	
				Clutch type	Wing nut type
1/4	6.35	0.8	0~0.5	0.5~1.0	1.0~1.5
3/8	9.52	0.8	0~0.5	0.5~1.0	1.0~1.5
1/2	12.70	0.8	0~0.5	0.5~1.0	1.5~2.0
5/8	15.88	1.0	0~0.5	0.5~1.0	1.5~2.0

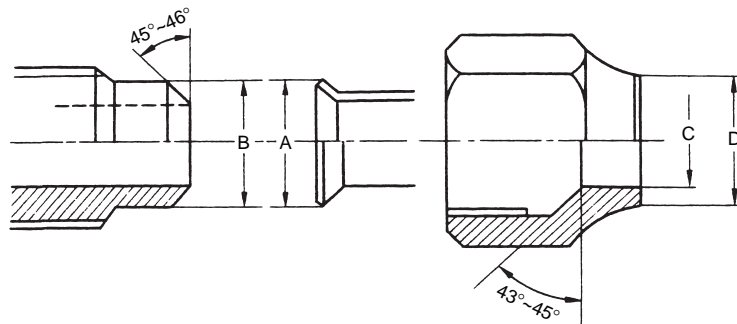

Fig.4 Relations between flare nut and flare seal surface

Table 7. Flare and flare nut dimensions for R410A

[unit: mm]

Nominal diameter	Outer diameter (mm)	Thickness (mm)	Dimension (mm)				Flare nut width
			A	B	C	D	
1/4	6.35	0.8	9.1	9.2	6.5	13	17
3/8	9.52	0.8	13.2	13.5	9.7	20	22
1/2	12.70	0.8	16.6	16.0	12.9	23	26
5/8	15.88	1.0	19.7	19.0	16.0	25	29

Table 8. Flare and flare nut dimensions for R22

[unit: mm]

Nominal diameter	Outer diameter (mm)	Thickness (mm)	Dimension (mm)				Flare nut width
			A	B	C	D	
1/4	6.35	0.8	9.0	9.2	6.5	13	17
3/8	9.52	0.8	13.0	13.5	9.7	20	22
1/2	12.70	0.8	16.2	16.0	12.9	20	24
5/8	15.88	1.0	19.4	19.0	16.0	23	27

(2) Flare connecting procedures and precautions

- a) Make sure that the flare and union portions do not have any scar or dust, etc.
- b) Correctly align the processed flare surface with the union axis.
- c) Tighten the flare with designated torque by means of a torque wrench. The tightening torque for R410A is same as that for conventional R22. Incidentally, when the torque is weak, the gas leakage may occur. When it is strong, the flare nut may crack and may be made nonremovable. When choosing the tightening torque, comply with values designated by manufacturers.

Table 9 shows reference values.

Note : When applying oil to the flare surface, be sure to use oil designated by the manufacturer. If any other oil is used, the lubricating oils may deteriorate and cause the compressor to burn out.

Table 9. Tightening torque of flare for R410A [Reference values]

Nominal diameter	Outer diameter (mm)	Tightening torque N·m (kgf·cm)	Tightening torque of torque wrenches available on the market N·m (kgf·cm)
1/4	6.35	14~18 (140~180)	16 (160), 18 (180)
3/8	9.52	33~42 (330~420)	42 (420)
1/2	12.70	50~62 (500~620)	55 (550)
5/8	15.88	63~77 (630~770)	65 (650)

7.2.3 Storage of piping materials

(1) Types and storage of piping materials

Refrigerant piping materials for air conditioners are broadly classified into the following types.

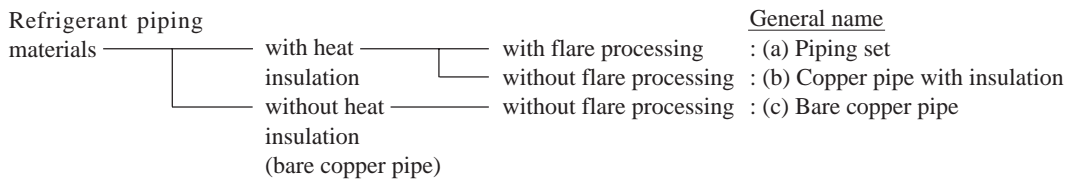

As R410A features pressure about 1.6 times higher than R22, it is necessary to use a copper pipe which has a thickness stated in Table 3 (see on page 37) and which contains less contaminants. It is necessary to carefully treat/store copper pipes so that they are not collapsed, deformed or damaged. Due care must also be exercised so that foreign matters such as dust and water do not enter the pipe interior.

A piping set's open end is sealed with a cap, etc. When storing it, make sure that it is sealed securely. When storing a clad copper pipe or bare copper pipe, securely seal the opening with pinching, taping, etc.

(2) Identification

a) Piping set

A copper pipe as piping set for R410A must have a thickness as stated in Table 3 (see on page 37), and, as shown in Tables 5 and 6 (see on page 39), it also differs from R22 in flare processing and flare nut dimensions. So, it is necessary to choose a piping set suitable for R410A.

b) Copper pipe with insulation

Before using a copper pipe with insulation, make sure that it has a thickness designated for R410A.

c) Bare copper pipe

It is necessary to use a bare copper pipe which has a thickness designated in Table 3 (see on page 37) and contains less contaminants. As the bare copper pipe surface is naked, it is necessary to treat it with exceeding care and adopt a means for identification to prevent improper usage by making it easily discriminable from other piping materials.

(3) Precautions before installation

Observe the following precautions when performing the piping connection at the site.

a) Keep any open ends of pipes be sealed with a cap, etc. until connected with the equipment.

b) Exercise great care when performing piping installation on a rainy day.

When water enters into the piping, the lubricating oil may deteriorate and cause the equipment to fail.

c) Carry out the piping connection in as short a time as possible.

If the piping is left open for a long period, fully purge the interior with nitrogen gas or dry it with a vacuum pump.

7.2.4 Brazing

(1) Processing the connected parts

As brazing is molten between the joined surfaces to yield high adhesive strength, it is necessary to secure a wide enough space to be joined and also an adequate clearance between the joined surfaces. Copper pipe joints' minimum insertion depths, outer pipe diameters and clearances between outer and inner pipe diameters are as shown in Table 10. In the case of bronze brazing filler, when the clearance is about 0.05~0.1mm, the pipes can be connected most strongly.

Table 10. Copper pipe joints' minimum insertion depths and clearances

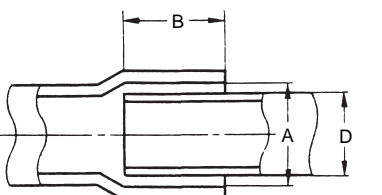

Outer pipe diameter D (mm)	Minimum insertion depth B (mm)	Clearance (A-D) × 1/2 (mm)
5~8	6	0.05~0.35
8~12	7	0.05~0.35
12~16	8	0.05~0.45

* When joining the pipes, either the pipe ends are processed, or pipes are connected by brazing with a socket joint.

(2) Brazing filler metal

a) Alloy brazing filler

An alloy mainly composed of silver and copper is used to join iron, copper or copper alloy. Although it excels in solderability, it is relatively expensive.

b) Phosphor bronze brazing filler

Phosphor bronze brazing filler is generally used to join copper or copper alloy.

c) Low temperature solder

An alloy of tin and lead. An ordinary type of solder. Since it is weak in adhesive strength, it should not be used for refrigerant pipe brazing.

* Cautions:

- 1) BCuP tends to react with sulphur and produce a fragile compound water solution, which may cause a gas leakage. So, use any other type of brazing filler at a hot spring resort, etc., and coat the surface with a paint.
- 2) When performing brazing again at the time of servicing, use the same type of brazing filler.

(3) Flux

a) Reasons for the use of flux

- By removing the oxide film and any foreign matter on the metal surface, it assists the flow of brazing filler.
- In the brazing process, it prevents the metal surface from being oxidized.
- By reducing the brazing filler's surface tension, the brazing filler adheres better to the treated metal.

b) Properties required for flux

- Temperature at which flux is active coincides with the brazing temperature.
- Due to a wide effective temperature range, flux is hard to carbonize.
- It is easy to remove slag after brazing.
- The corrosive action to the treated metal and brazing filler is negligible.
- Excels in coating performance and is harmless to the human body.

As the flux works in a complicated manner as described above, it is necessary to choose an adequate type of flux according to the type and shape of treated metal, type of brazing filler and brazing method, etc.

c) Types of flux

• Incorruptible flux

Generally, it is a compound of borax and boric acid.

Effective in cases where the brazing temperature is higher than 800°C.

• Activated flux

Most of fluxes generally used for silver brazing fall under this type.

It features an increased oxide film removing capability due to the addition of compounds such as potassium fluoride, potassium chloride and sodium fluoride, to the borax-boric acid compound.

* Cautions:

- ① Remove the flux after brazing.
- ② When chlorine contained in the flux stays within the pipe, the lubricating oil deteriorates. So, use a flux which does not contain chlorine.
- ③ When adding water to the flux, use water which does not contain chlorine (e.g. distilled water or ion-exchange water).

(4) Brazing

As brazing requires sophisticated techniques and experiences, it must be performed by a qualified person.

In order to prevent the oxide film from occurring in the pipe interior during brazing, it is effective to proceed with brazing while letting dry nitrogen gas (N₂) flow.

<Brazing method for preventing oxidation>

- a) Attach a reducing valve to the nitrogen gas cylinder
- b) Use a copper pipe to direct the nitrogen gas into the piping, and attach a flowmeter to the nitrogen gas cylinder.
- c) Apply a seal onto the clearance between the piping and inserted pipe for the nitrogen gas in order to prevent the nitrogen gas from flowing backward.
- d) When the nitrogen gas is flowing, be sure to keep the piping end open.
- e) Adjust the flow rate of nitrogen gas so that it is lower than 0.05m³/h, or 0.02MPa (0.2kgf/cm²) by means of the reducing valve.
- f) After taking the steps above, keep the nitrogen gas flowing until the piping cools down to a certain extent (i.e. temperature at which pipes are touchable with finger).
- g) Completely remove the flux after brazing.

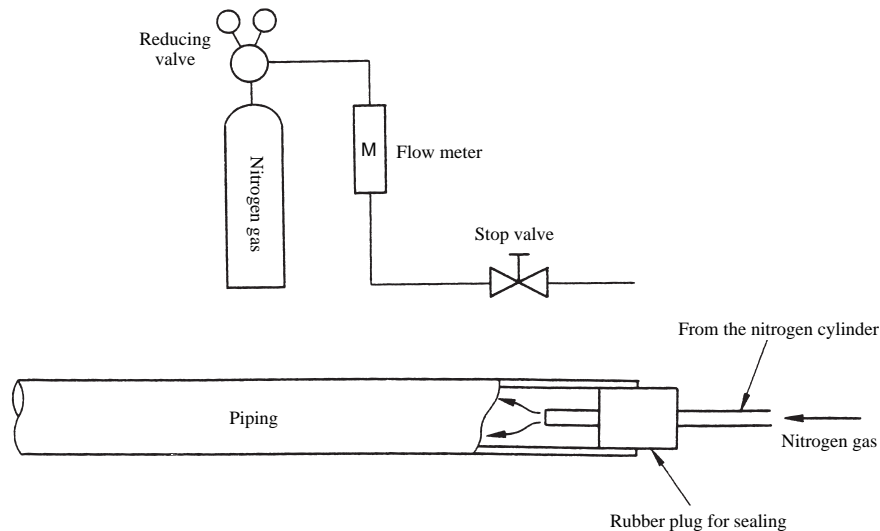

Fig.5 Prevention of oxidation during brazing

* Cautions during brazing

① General cautions

- 1) The brazing strength should be high as required.
- 2) After operation, airtightness should be kept under a pressurized condition.
- 3) During brazing do not allow component materials to become damaged due to overheating.
- 4) The refrigerant pipe work should not be come blocked with scale or flux.
- 5) The brazed part should not restrict the flow in the refrigerant circuit.
- 6) No corrosion should occur from the brazed part.

② Prevention of overheating

Due to heating, the interior and exterior surfaces of treated metal may oxidize. Especially, when the interior of the refrigerant circuit oxidizes due to overheating, scale occurs and stays in the circuit as dust, thus exerting a fatally adverse effect. So, make brazing at adequate brazing temperature and with a minimum of heating area.

③ Overheating protection

In order to prevent components near the brazed part from overheating damage or quality deterioration due to flame or heat, take adequate steps for protection such as (1) by shielding with a metal plate, (2) by using a wet cloth, and (3) by means of heat absorbent.

④ Movement during brazing

Eliminate all vibration during brazing to protect brazed joints from cracking and breakage.

⑤ Oxidation preventive

In order to improve the brazing efficiency, various types of antioxidant are available on the market. However, the constituents of these are widely varied, and some are anticipated to corrode the piping materials, or adversely affect HFC refrigerant, lubricating oil, etc. Exercise care when using an oxidation preventive.

7.3 Installation, removal and servicing

7.3.1 Tools for R410A

In the case of an air conditioner using R410A, in order to prevent any other refrigerant from being charged accidentally, the service port diameter of the outdoor unit control valve (3-way valve) has been changed. Also, to increase the pressure resisting strength, flare processing dimensions and sizes of opposite sides of flare nuts (for copper pipes with nominal diameters 1/2 and 5/8) have been changed. During installation/service, therefore, prepare tools exclusive for R410A shown in (1) on page 44 and general tools shown in (2) on page 45.

(1) Tools exclusive for R410A

a) Gauge manifold

- As R410A is characterized by high pressure, conventional tools cannot be used.

Table 11. Differences between conventional high/low pressure gauges and those for R410A

	Conventional gauges	Gauges exclusive for R410A
High pressure gauge (red)	-0.1~3.5MPa -76 cmHg~35 kgf/cm ²	-0.1~5.3MPa -76 cmHg~53 kgf/cm ²
Compound gauge (blue)	-0.1~1.7MPa -76 cmHg~17 kgf/cm ²	-0.1~3.8MPa -76 cmHg~38 kgf/cm ²

- In order to prevent any other refrigerant from being charged accidentally, each port of the manifold has been changed in shape.

Table 12. Differences in port size between conventional manifold and that for R410A

	Conventional manifold	Manifold for R410A
Port size	7/16 UNF 20 threads per inch	1/2 UNF 20 threads per inch

b) Charge hose

- As R410A is characterized by high pressure, the pressure resistance of the charge hose has been increased. The material has also been changed to an HFC resistant type, and, as in the case of each port of the manifold, the hose cap size has been changed. Furthermore, for prevention of gas pressure reaction, a charge hose with a valve placed near the cap is also available.

Table 13. Differences between conventional charge hose and that for R410A

		Conventional charge hose	Charge hose for R410A
Pressure resistance	Normal pressure	3.4 MPa (34 kgf/cm ²)	5.1 MPa (51 kgf/cm ²)
	Breaking pressure	17.2 MPa (172 kgf/cm ²)	27.4 MPa (274 kgf/cm ²)
Engineering material		NBR rubber	HNBR rubber internally coated with nylon
Cap size		7/16 UNF 20 threads per inch	1/2 UNF 20 threads per inch

c) Electronic balance for refrigerant charging

- As R410A belonging to the HFCs features high pressure and high evaporating speed, when R410A is charged by using a charging cylinder, R410A in the cylinder cannot be kept in a liquefied state and gasified refrigerant bubbles in the charging cylinder, it becomes difficult to read values. Therefore, it is advisable to adequately use an electronic balance for refrigerant charging.
- An electronic balance for refrigerant charging has higher strength due to its structure with four points of support for refrigerant cylinder weight detection. As the charge hose connecting part has two ports-one for R22 (7/16 UNF 20 threads per inch) and the other for R410A (1/2 UNF 20 threads per inch) - it can also be used for charging the conventional refrigerant.
- Two types of electronic balance for refrigerant charging are available - one for 10kg cylinder and the other for 20kg cylinder.
Electronic balance for 10kg cylinderprecision ± 2g
Electronic balance for 20kg cylinderprecision ± 5g
- Refrigerant is charged manually by opening/closing the valve.

d) Torque wrench (for nominal diameters 1/2 and 5/8)

- Along with changes in flare nut sizes for enhanced pressure resisting strength, torque wrenches for R410A differ in opposite side size.

Table 14. Differences between conventional wrenches and those for R410A

	Conventional torque wrench	Torque wrench for R410A
For 1/2 (opposite side × torque)	24mm × 55N·m (550 kgf·cm)	26mm × 55N·m (550 kgf·cm)
For 5/8 (opposite side × torque)	27mm × 65N·m (650 kgf·cm)	29mm × 65N·m (650 kgf·cm)

- e) Flare tool (clutch type)
 - A flare tool for R410A is provided with a large clamp bar receiving hole so that the projection of the copper pipe from the clamp bar can be set at 0~0.5 mm in flare processing, and also features higher spring strength for increased expansion pipe torque. This flare tool can also be used for R22 copper pipe.
- f) Gauge for projection adjustment (used when flare processing is made by using conventional flare tool [clutch type])
 - A gauge 1.0 mm in thickness which helps in easily setting the projection of the copper pipe from the clamp bar at 1.0~1.5 mm.
- g) Vacuum pump adapter
 - It is necessary to use an adapter for preventing vacuum pump oil from flowing back to the charge hose. The charge hose connecting part has two ports - one for conventional refrigerant (7/16 UNF 20 threads per inch) and the other for R410A. If the vacuum pump oil (mineral) mixes with R410A, a sludge may occur and damage the equipment.
- h) Refrigerant cylinder
 - A refrigerant cylinder exclusive for R410A comes identified with refrigerant name and is coated with pink paint as designated by the ARI, U.S.A.
- i) Charge port and packing for refrigerant cylinder
 - According to the charge hose's cap size, a charge port with 1/2 UNF 20 threads per inch and corresponding packing are required.
- j) Gas leakage detector
 - A high sensitivity gas leakage detector exclusive for HFC refrigerant is used. In the case of R410A, the detection sensitivity is about 23g per year.

(2) General tools

- a) Vacuum pump
- b) Torque wrench
 - for 1/4: opposite side 17 mm × $\begin{matrix} (16 \text{ N}\cdot\text{m}) \\ (160 \text{ kgf}\cdot\text{cm}) \end{matrix}$
 - for 1/4: opposite side 17 mm × $\begin{matrix} (18 \text{ N}\cdot\text{m}) \\ (180 \text{ kgf}\cdot\text{cm}) \end{matrix}$
 - for 3/8: opposite side 22 mm × $\begin{matrix} (42 \text{ N}\cdot\text{m}) \\ (420 \text{ kgf}\cdot\text{cm}) \end{matrix}$
- c) Pipe cutter
- d) Reamer
- e) Screwdriver (+, -)
- f) Hacksaw
- g) Hole core drill (ø65 or 70)
- h) Hexagonal wrench (opposite side 4 or 5 mm)
- i) Spanner, or monkey wrench
- j) Tape measure
- k) Thermometer
- l) Clamping ampere meter
- m) Insulation resistance tester (mega tester)
- n) Electro circuit tester
- o) Pipe bender

(3) Applicability of R410A tools to R22 model

Table 15. Applicability of R410A tools to R22 model

	Tools for R410A	Applicable to R22 model
a)	Gauge manifold	×
b)	Charge hose	×
c)	Electronic balance for refrigerant charging	○
d)	Torque wrench (nominal diameter 1/2, 5/8)	×
e)	Flare tool (clutch type)	○
f)	Gauge for projection adjustment*	○
g)	Vacuum pump adapter	○
h)	Refrigerant cylinder	×
i)	Charge port and packing for refrigerant cylinder	×
j)	Gas leakage detector	×

* Used when conventional flare tool (clutch type) is used.

Note: For inquiry, contact your agent.

7.3.2 New installation work (when using new refrigerant piping)

- (1) Air purge by vacuum pump and gas leakage inspection (see Fig. 6)
 - a) Connect the charge hose to the outdoor unit. ①
 - b) Connect the charge hose to the vacuum pump adapter. ②
At this time, keep the control valves in the fully closed position. ③ ④
 - c) Place the handle *Lo* in the fully opened position ⑤, and turn on the vacuum pump's power switch.
During this step, perform evacuating (about 10 ~ 15 minutes); for the evacuating time, refer to the equipment manufacturer's manual.
 - d) When the compound gauge's pointer has indicated -0.1 MPa (-76 cmHg) ⑥, place the handle *Lo* in the fully closed position ⑤, and turn OFF the vacuum pump's power switch
Keep this state for 1~2 minutes, and ascertain that the compound gauge's pointer does not return.
 - e) Fully open the control valves. ③ ④
 - f) Detach the charge hoses. ① ②
 - g) Tightly secure the cap on the service port. ⑦
 - h) After securing the caps on the control valves, check the caps' periphery if there is any gas leakage. ③ ④ ⑦

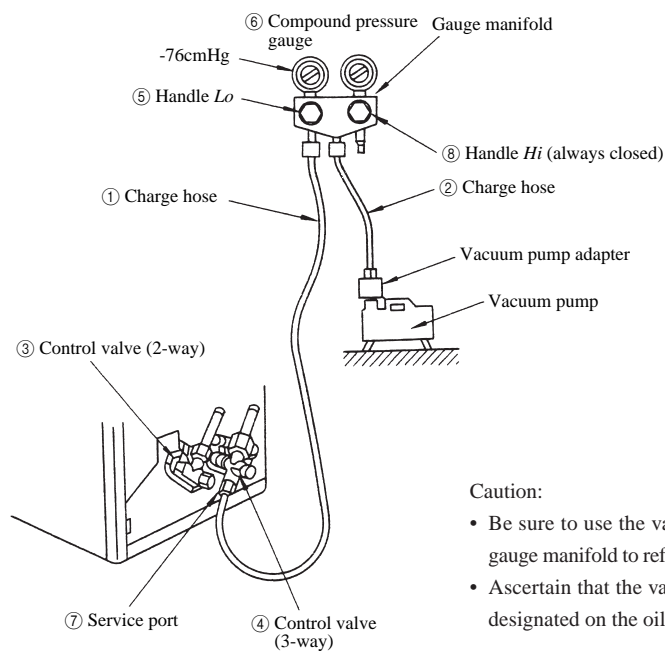

Caution:

- Be sure to use the vacuum pump, vacuum pump adapter and gauge manifold to refer to their instruction manuals beforehand.
- Ascertain that the vacuum pump is filled with oil to the level designated on the oil gauge.

Fig.6 Configuration of air purge by vacuum pump

- (2) Additional refrigerant charging required for refrigerant piping length longer than standard length (The following steps should be taken following the step e) in (1) above. See Fig. 7)
 - a) Set the refrigerant cylinder to the electronic balance, and connect the connecting hoses on the cylinder and electronic balance's connecting port.
* Caution:
Be sure to make setting so that liquid can be charged. When using a cylinder equipped with a siphon, liquid can be charged without turning it upside down.
 - b) Connect the gauge manifold's charge hose to the electronic balance's connecting port. ③ ②
 - c) Open the refrigerant cylinder's valve, and, after opening the charging valve a little, close it. ① ②
 - d) After making zero (0) adjustment, open the charging valve and, by opening the gauge manifold's valve *Lo*, charge the liquid refrigerant. ② ⑤
(Before handling the electronic balance, refer to its instruction manual).
 - e) When the designated amount of refrigerant could not be charged, make additional charging bit by bit by cooling operation (for the amount of each addition, follow the instruction manual prepared by the equipment manufacturer). If the first additional charging was not enough, make the second additional charging after about one minute in the same manner as the first additional charging.
* Caution:
Be sure never to charge a large amount of liquid refrigerant at once to the unit in cooling mode, since liquid is charged from the gas side.

- f) After charging liquid refrigerant into the air conditioner by closing the charging valve, stop operation by fully closing the gauge manifold's valve Lo. ② ⑤
- g) Quickly remove the charge hose from the service port. ⑥
When stopped halfway, refrigerant being cycled will be released.
- h) After securing the caps on the service port and control valve, check the caps' periphery to see if there is any gas leakage. ⑥ ⑦

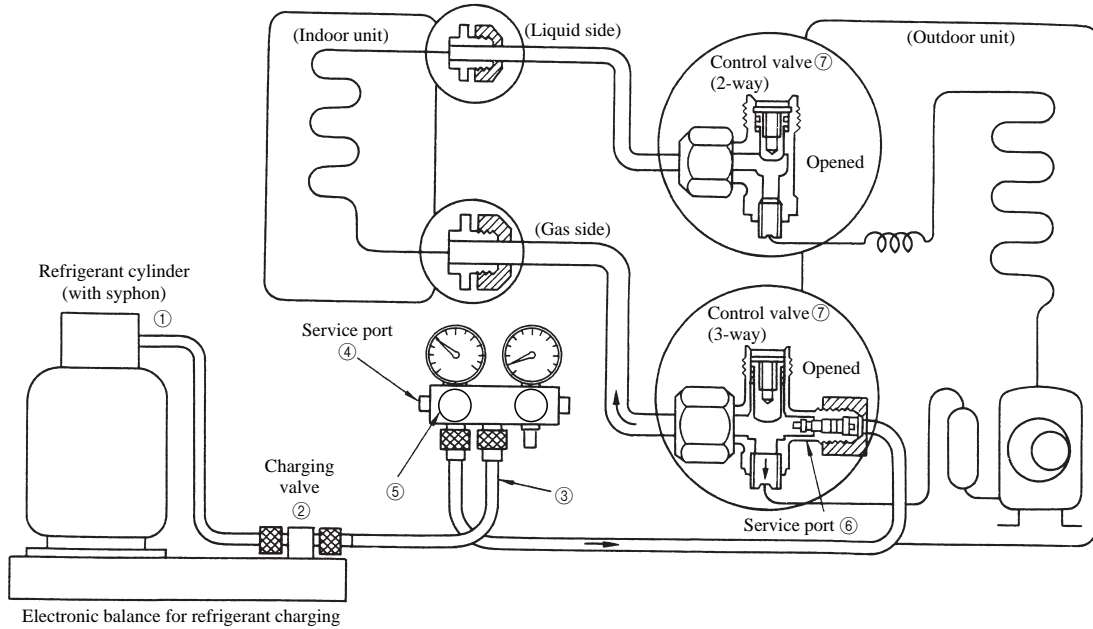

Fig.7 Configuration of additional refrigerant charging

7.3.3 Removal (When using new refrigerant piping)

- (1) Removing the unit
 - a) Recovery of refrigerant from the outdoor unit by pump down
 - At the time of pump down, use a gauge manifold exclusive for R410A.
 - Operating the unit in forced cooling mode, recover refrigerant from the outdoor unit.
(For details of reclaiming steps and precautions, see the instruction manual prepared by the equipment manufacturer)
 - * Caution:
In the case of an outdoor unit which is incapable of pump down, use a refrigerant recovery unit.
 - b) Removing the indoor/outdoor units
 - Remove the piping and wiring between the indoor and outdoor units.
 - Tighten the outdoor unit's control valves and service port with the specified torque.
 - Tighten the capped flare nuts at the indoor/outdoor units connecting part with the specified torque.
 - Remove the indoor/outdoor units.
 - * Caution:
When storing the indoor unit piping in its original position, be careful not to break the piping.
- (2) Installing the unit
 - a) Proceed with the installation following the steps described in "7.3.2 New installation work".

7.3.4 Replacing the unit (Never use the existing refrigerant piping)

Use a brand-new refrigerant piping (1) when replacing the air conditioner using the conventional refrigerant (R22) with an air conditioner using the alternative refrigerant (R410A) or (2) even when replacing the air conditioner using the alternative refrigerant (R410A) with another air conditioner using R410A, as a problem may occur due to differences in pressure characteristics of refrigerant or differences in type of lubricating oil (air conditioners using R410A do not always use the same type of the lubricating oils).

7.3.5 Retrofitting

Do not operate the air conditioner which has used the conventional refrigerant (R22) by charging the alternative refrigerant (R410A). Otherwise, the equipment may cease to function normally and go wrong, or even cause serious problems such as rupture of the refrigeration cycle.

7.3.6 Refrigerant recharging at servicing

When it becomes necessary to recharge refrigerant, charge the specified amount of new refrigerant according to the following steps.

(For details, see the instruction manual prepared by the equipment manufacturer)

- 1) Connect the charge hose to the outdoor unit's service port.
- 2) Connect the charge hose to the vacuum pump adapter. At this time, keep the control valves in the fully opened position.
- 3) Place the handle *Lo* in the fully opened position, and turn ON the vacuum pump's power source. (For the evacuating time, refer to the equipment manufacturer's manual)
- 4) When the compound gauge's pointer has indicated -0.1 MPa (-76 cmHg), place the handle *Lo* in the fully closed position, and turn OFF the vacuum pump's power source. Keep this state for 1 ~ 2 minutes, and ascertain that the compound gauge's pointer does not return.
- 5) Charge liquid refrigerant by using the electronic balance according to the steps described in Section 7.3.2 (2) (pages46~47).

7.4 Refrigerant recovery

7.4.1 Recovering procedures

The following procedures for refrigerant recovery represent general procedures, and they may differ between actual cases depending upon the type of refrigerant recovering equipment. The connecting and handling methods for different type of refrigerant recovering equipment may also differ. So, ascertain the details by referring to the respective instruction manuals, etc.

- (1) Checks prior to recovering procedures
 - a) Checking the refrigerant recovering equipment
 - ① Gas leakage [If there is any malfunction, repair it].
 - ② Oil separator [Drain the residual oil].
 - ③ Recovering equipment weighing function, overcharge preventing function (float switch), moisture indicator, drier and other accessory functions [should be adjusted or replaced where necessary].
 - ④ Electrical circuit
 - b) Checking the accessories to the refrigerant recovering equipment
- (2) Preparations for recovering procedures
 - a) Installation of refrigerant recovering equipment

Install the equipment in a place which satisfies the following requirements as much as possible.

 - ① Ambient temperature is higher than 0°C and lower than 40°C.
 - ② A flat and dry floor.
 - ③ A place as close to the air conditioner as possible.
 - b) Preparation of recovering cylinder

A recovering cylinder should be such that it does not go against prohibitions, and is suitable for refrigerant recovered.
 - c) Connect to the power source
 - d) Preparations for air conditioner subjected to refrigerant recovery
 - ① When it is possible to run the air conditioner subjected to refrigerant recovery, perform pump down operation so that refrigerant is contained in the outdoor unit (condenser side).
 - Carry out the pump down operation after confirming the specification of the air conditioner subjected to refrigerant recovery.
 - ② If there is any clogging part (ex. the electronic expansion valve, etc.), fully open such part.

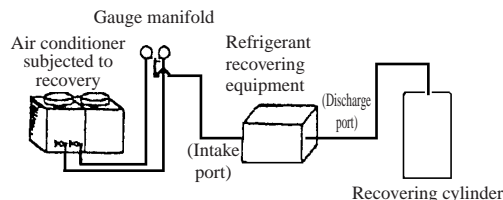

- (3) Connection of refrigerant recovering equipment
 - a) Connect the air conditioner subjected to refrigerant recovery to the refrigerant recovering equipment.
 - ① When there is a service port (port for recovery):

Make connection to the service port (port for recovery) by using a gauge manifold and charge hose.
 - ② When there is no service port (port for recovery):

Make connection in a manner similar to ① above by using a piercing valve.
 - b) Connect the refrigerant recovering equipment to the recovering cylinder.

- (4) Recovering procedures
- a) According to the instructions for handling the refrigerant recovering equipment (described in the attached instruction manual), operate the equipment to recover refrigerant.
 - b) During the operation, take care of the following cautions.
 - ① Ascertain that the refrigerant recovering equipment is running as required and always monitor the state of operation so that adequate steps can be taken in an emergency.
 - ② During the operation, remain at work site to ensure safety.
 - ③ If you have to leave your work site for any unavoidable reason, stop the operation after ascertaining that the recovering cylinder is not overcharged.
 - c) During the operation, if the refrigerant recovering equipment's overcharging prevention mechanism operates and the equipment stops automatically, replace the recovering cylinder with an empty one.
 - d) If the pressure gauge's reading increases after a short time from the accomplishment of recovery and automatic stoppage of the refrigerant recovering equipment, restart the equipment and, if it stops again, finish the recovery.
- (5) Procedures after recovery
- a) Close the valves on the air conditioner subjected to refrigerant recovery, the refrigerant recovering equipment and the recovering cylinder.
 - b) Detach the recovering cylinder charged with refrigerant and store it as required by law.

7.4.2 Accessories/tools

In order to carry out R410A recovery, a variety of accessories/tools are required.

Shown below are standard accessories.

(1) Recovering cylinder

- Use a recovering cylinder designated by the equipment manufacturer.
- A detachable cylinder must be such that it complies with the laws and regulations concerned.
- Do not use an ordinary cylinder as a recovering cylinder.

Note 1: A cylinder available when R410A was purchased, is a borrowed one.

Note 2: As a cylinder available when R410A was purchased, is provided with a check valve, it cannot be used as a recovering cylinder.

- Types (by function)

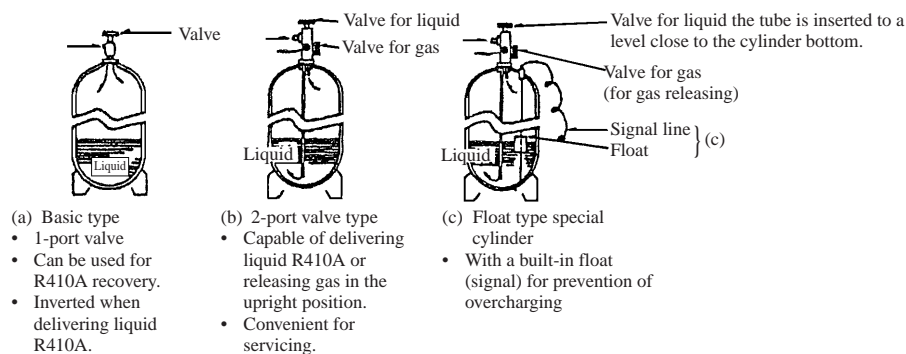

Fig.8 Cylinder types

- Caution

It is prohibited by law to recover R410A into a throw-away service can or one-way cylinder.

(2) Drier

- A desiccant container for removing the water content of R410A.
- A drier should be prepared as expendables.
- Keep the drier sealed just before fitting it.
- Required to protect the R410A recovering equipment.

(3) Connection hose

a) Charge port and charge port packing

- Usually, it is sold independently of a refrigerant cylinder.
- In the case of a two-port cylinder, the diameter may be special. Inquire the manufacture for confirmation.
- A packing is expendables.

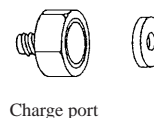

b) Charge hose (pressure resistant hose for fluorocarbon) and packing

- It is 1/4B in thickness and available in various lengths, etc.
- Use a hose whose pressure resisting performance is higher than 5.2 MPa (52 kg/cm²G).
- Generally, a setting fixture is provided only on one end.

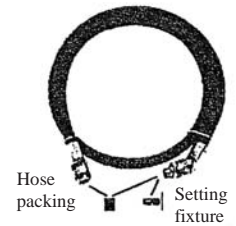

(4) Gauge manifold

- The most important service tool for refrigeration and air conditioner.
- Widely used when charging/recovering R410A while checking gas pressure.

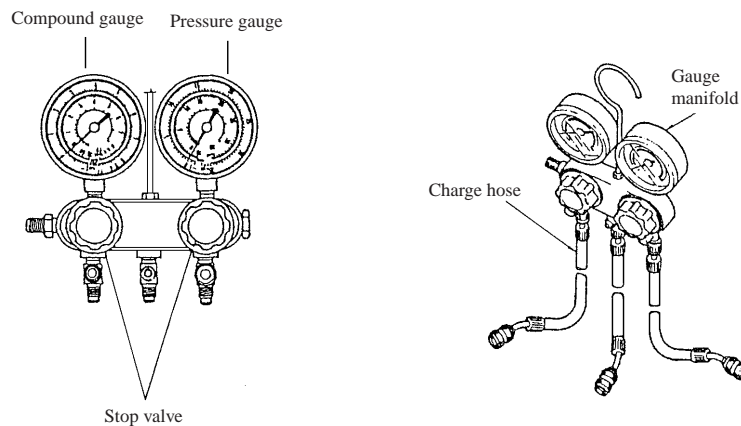

(5) Tube piercing valve

- A tool used to make a hole for recovery in the copper pipe when recovering R410A from equipment which has no port for charging or recovering gas. Various types are available on the market and given various names.
- As the piercing edge tends to wear, it is necessary to treat this valve as semi-expendables.
- As vacuum rises, air tends to be inhaled from the hole. So, care must be exercised.

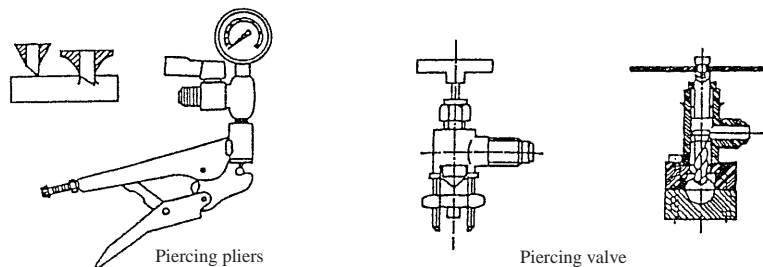

(6) Vacuum pump

Used to evacuate the recovering equipment and recovering cylinder.

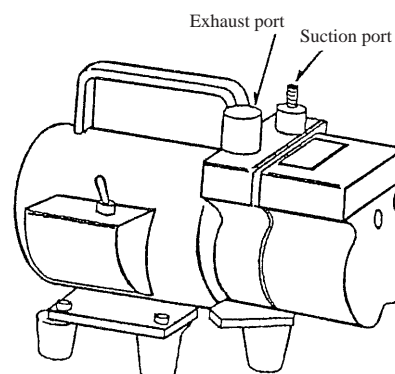

**WALL MOUNTED TYPE
ROOM AIR-CONDITIONER**



Air-Conditioning & Refrigeration Systems Headquarters
16-5, 2-chome, Kounan, Minato-ku, Tokyo, 108-8215, Japan
Fax : (03) 6716-5926