

**MHI**

**TECHNICAL MANUAL**

**INVERTER WALL MOUNTED TYPE  
RESIDENTIAL AIR-CONDITIONERS**  
(Split system, air to air heat pump type)

**SRK20ZM-S**

**25ZM-S**

**35ZM-S**

**50ZM-S**



## CONTENTS

<b>1. SPECIFICATIONS</b>	<b>3</b>
<b>2. EXTERIOR DIMENSIONS</b>	<b>7</b>
(1) Indoor units	7
(2) Outdoor units	8
(3) Remote control	10
<b>3. ELECTRICAL WIRING</b>	<b>12</b>
(1) Indoor units	12
(2) Outdoor units	13
<b>4. NOISE LEVEL</b>	<b>15</b>
<b>5. PIPING SYSTEM</b>	<b>19</b>
<b>6. RANGE OF USAGE &amp; LIMITATIONS</b>	<b>21</b>
<b>7. CAPACITY TABLES</b>	<b>23</b>
<b>8. APPLICATION DATA</b>	<b>25</b>
(1) Installation of indoor unit	25
(2) Installation of outdoor unit	29
<b>9. OUTLINE OF OPERATION CONTROL BY MICROCOMPUTER</b>	<b>37</b>
(1) Operation control function by wireless remote control	37
(2) Unit ON/OFF button	38
(3) Auto restart function	38
(4) Installing two air conditioners in the same room	38
(5) Selection of the annual cooling function	39
(6) High power operation	39
(7) Economy operation	39
(8) Flap and louver control	40
(9) 3D auto operation	41
(10) Timer operation	42
(11) Silent mode	42
(12) Night setback	42
(13) Installation location setting	42
(14) Outline of heating operation	43
(15) Outline of cooling operation	44
(16) Outline of dry (dehumidifying) operation	45
(17) Outline of automatic operation	45
(18) Protective control function	46
<b>10. MAINTENANCE DATA</b>	<b>54</b>
(1) Cautions	54



(2) Items to check before troubleshooting .....	54
(3) Troubleshooting procedure (If the air conditioner does not run at all) .....	54
(4) Troubleshooting procedure (If the air conditioner runs) .....	55
(5) Self-diagnosis table .....	56
(6) Service mode (Trouble mode access function) .....	57
(7) Inspection procedures corresponding to detail of trouble .....	65
(8) Phenomenon observed after shortcircuit, wire breakage on sensor .....	70
(9) Checking the indoor electrical equipment .....	70
(10) How to make sure of wireless remote control .....	72
(11) Inspection procedure for blown fuse on the indoor and outdoor PCB ....	72
(12) Outdoor unit inspection points .....	73
<b>11. OPTION PARTS .....</b>	<b>76</b>
(1) Wired remote control (RC-E5) .....	76
(2) Interface kit (SC-BIKN-E) .....	82
(3) Super link E board (SC-ADNA-E) .....	86
<b>12. TECHNICAL INFORMATION .....</b>	<b>88</b>

■ How to read the model name

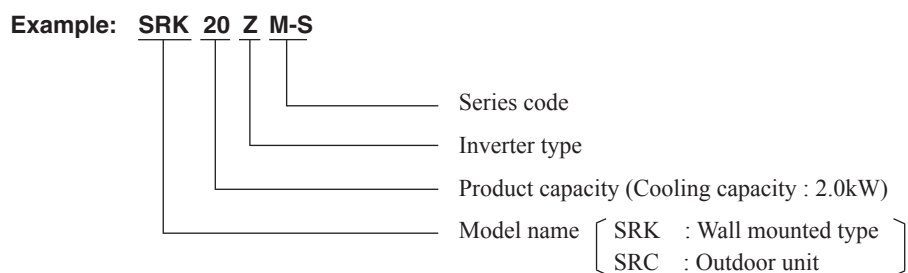

# 1. SPECIFICATIONS

Item		Model	SRK20ZM-S				
			Indoor unit SRK20ZM-S		Outdoor unit SRC20ZM-S		
Power source			Single phase, 220 - 240V, 50Hz				
Operation data	Nominal cooling capacity (range)	kW	2.0 ( 1.0 (Min.) - 2.7 (Max.))				
	Nominal heating capacity (range)	kW	2.7 ( 1.2 (Min.) - 3.9 (Max.))				
	Power consumption	Cooling	kW	0.44 ( 0.21 - 0.77 )			
		Heating		0.62 ( 0.27 - 1.38 )			
	Max power consumption			1.65			
	Running current	Cooling	A	2.5 / 2.4 / 2.3 (220/ 230/ 240 V)			
		Heating		3.2 / 3.1 / 3.0 (220/ 230/ 240 V)			
	Inrush current, max current			3.2 / 3.1 / 3.0 (220/ 230/ 240 V) Max. 9			
	Power factor	Cooling	%	79.7			
		Heating		87			
	EER	Cooling		4.55			
	COP	Heating		4.35			
	Sound power level	Cooling	dB(A)	49		59	
		Heating		52		58	
Sound pressure level	Cooling		Hi: 33 Me: 27 Lo: 24 ULo: 21	47			
	Heating		Hi: 36 Me: 31 Lo: 24 ULo: 21	46			
Silent mode sound pressure level			—				
Exterior dimensions (Height x Width x Depth)		mm	294 x 798 x 229		540 x 780(+62) x 290		
Exterior appearance ( Munsell color )			Fine snow ( 8.0Y 9.3/0.1 ) near equivalent		Stucco white ( 4.2Y 7.5/1.1 ) near equivalent		
Net weight		kg	9.5		31.5		
Compressor type & Q'ty			—		RM-B5077MDE1( Rotary type ) x 1		
Compressor motor (Starting method)		kW	—		0.75 ( Inverter driven )		
Refrigerant oil (Amount, type)		ℓ	—		0.35 (DIAMOND FREEZE MA68)		
Refrigerant (Type, amount, pre-charge length)		kg	R410A 0.75 in outdoor unit (incl. the amount for the piping of 15m )				
Heat exchanger			Louver fins & inner grooved tubing		M fins & inner grooved tubing		
Refrigerant control			Capillary tubes + Electronic expansion valve				
Fan type & Q'ty			Tangential fan x 1		Propeller fan x 1		
Fan motor (Starting method)		W	30 x1 (Direct drive)		24 x1 (Direct drive)		
Air flow	Cooling	m <sup>3</sup> /min	Hi: 7.8 Me: 5.6 Lo: 5.3 ULo: 4.8		29.5		
	Heating		Hi: 9.8 Me: 6.3 Lo: 5.0 ULo: 4.5		25.6		
Available external static pressure		Pa	0		0		
Outside air intake			Not possible				
Air filter, Quality / Quantity			Polypropylene net ( washable ) x 2				
Shock & vibration absorber			Rubber sleeve (for fan motor)		Rubber sleeve (for fan motor & compressor)		
Electric heater			—				
Operation control	Remote control		Wireless remote control				
	Room temperature control		Microcomputer thermostat				
	Operation display		RUN: Green, TIMER: Yellow, HI POWER: Green, 3D AUTO: Green				
Safety equipments			Compressor overheat protection, Overcurrent protection, Frost protection, Serial signal error protection, Indoor fan motor error protection, Heating overload protection (High pressure control), Cooling overload protection				
Installation data	Refrigerant piping size (O.D)	mm	Liquid line : ϕ 6.35 (1/4") Gas line : ϕ 9.52 (3/8")				
	Connecting method		Flare connection		Flare connection		
	Attached length of piping	m	Liquid line : 0.53 / Gas line : 0.40		—		
	Insulation for piping		Necessary (Both sides), independent				
	Refrigerant line (one way) length	m	Max. 15				
	Vertical height diff. between O.U. and I.U.	m	Max. 10 (Outdoor unit is higher) / Max. 10 (Outdoor unit is lower)				
Drain hose			Hose connectable ( VP 16 )		Holes ϕ 20 x 2 pcs		
Drain pump, max lift height		mm	—				
Recommended breaker size		A	16				
L.R.A. (Locked rotor ampere)		A	3.2 / 3.1 / 3.0 (220/ 230/ 240 V)				
Interconnecting wires	Size x Core number		1.5mm <sup>2</sup> x 4 cores (Including earth cable) / Terminal block (Screw fixing type)				
IP number			IPX0		IPX4		
Standard accessories			Mounting kit, Clean filter (Allergen clear filter x 1, Photocatalytic washable deodorizing filter x 1)				
Option parts			Interface kit (SC-BIKN-E)				
Note (1) The data are measured at the following conditions.			The pipe length is 7.5m.				
Operation	Item	Indoor air temperature		Outdoor air temperature		Standards	
		DB	WB	DB	WB		
	Cooling	27°C	19°C	35°C	24°C	ISO5151-T1	
Heating	20°C	—	7°C	6°C			
(2) This air-conditioner is manufactured and tested in conformity with the ISO.							
(3) Sound level indicates the value in an anechoic chamber. During operation these value are somewhat higher due to ambient conditions.							
(4) Select the breaker size according to the own national standard.							

Item		Model	SRK25ZM-S			
			Indoor unit SRK25ZM-S	Outdoor unit SRC25ZM-S		
Power source			Single phase, 220 - 240V, 50Hz			
Operation data	Nominal cooling capacity (range)		kW			
	Nominal heating capacity (range)		kW			
	Power consumption	Cooling	0.62 (0.21 - 0.88)			
		Heating	0.80 (0.27 - 1.36)			
	Max power consumption		1.65			
	Running current	Cooling	3.2 / 3.1 / 3.0 (220/ 230/ 240 V)			
		Heating	4.0 / 3.8 / 3.7 (220/ 230/ 240 V)			
	Inrush current, max current		4.0 / 3.8 / 3.7 (220/ 230/ 240 V) Max. 9			
	Power factor	Cooling	87			
		Heating	91.5			
	EER	Cooling	4.03			
	COP	Heating	4.00			
	Sound power level	Cooling	50	60		
		Heating	55	61		
Sound pressure level	Cooling	Hi: 34 Me: 28 Lo: 24 ULo: 21	48			
	Heating	Hi: 39 Me: 31 Lo: 24 ULo: 21	49			
Silent mode sound pressure level		-		Cooling:42 / Heating:45		
Exterior dimensions (Height x Width x Depth)		mm	294 x 798 x 229	540 x 780(+62) x 290		
Exterior appearance (Munsell color)			Fine snow (8.0Y 9.3/0.1) near equivalent	Stucco white (4.2Y 7.5/1.1) near equivalent		
Net weight		kg	9.5	31.5		
Compressor type & Q'ty			-	RM-B5077MDE1( Rotary type ) x 1		
Compressor motor (Starting method)		kW	-	0.75 ( Inverter driven )		
Refrigerant oil (Amount, type)		ℓ	-	0.35 (DIAMOND FREEZE MA68)		
Refrigerant (Type, amount, pre-charge length)		kg	R410A 0.75 in outdoor unit (incl. the amount for the piping of 15m )			
Heat exchanger			Louver fins & inner grooved tubing	M fins & inner grooved tubing		
Refrigerant control			Capillary tubes + Electronic expansion valve			
Fan type & Q'ty			Tangential fan x 1	Propeller fan x 1		
Fan motor (Starting method)		W	30 x1 (Direct drive)	24 x1 (Direct drive)		
Air flow	Cooling	m <sup>3</sup> /min	Hi: 7.9 Me: 6.0 Lo: 5.3 ULo: 5.0	32.1		
	Heating		Hi: 10.6 Me: 6.5 Lo: 5.1 ULo: 4.6	25.6		
Available external static pressure		Pa	0	0		
Outside air intake			Not possible			
Air filter, Quality / Quantity			Polypropylene net ( washable ) x 2			
Shock & vibration absorber			Rubber sleeve (for fan motor)	Rubber sleeve (for fan motor & compressor)		
Electric heater			-			
Operation control	Remote control		Wireless remote control			
	Room temperature control		Microcomputer thermostat			
	Operation display		RUN: Green, TIMER: Yellow, HI POWER: Green, 3D AUTO: Green			
Safety equipments			Compressor overheat protection, Overcurrent protection, Frost protection, Serial signal error protection, Indoor fan motor error protection, Heating overload protection (High pressure control), Cooling overload protection			
Installation data	Refrigerant piping size (O.D)		mm			
	Connecting method		Flare connection			
	Attached length of piping		m			
	Insulation for piping		Necessary (Both sides), independent			
	Refrigerant line (one way) length		m			
	Vertical height diff. between O.U. and I.U.		m			
Drain hose			Hose connectable ( VP 16 )	Holes φ 20 x 2 pcs		
Drain pump, max lift height		mm	-	-		
Recommended breaker size		A	16			
L.R.A. (Locked rotor ampere)		A	4.0 / 3.8 / 3.7 (220/ 230/ 240 V)			
Interconnecting wires		Size x Core number	1.5mm <sup>2</sup> x 4 cores (Including earth cable) / Terminal block (Screw fixing type)			
IP number			IPX0	IPX4		
Standard accessories			Mounting kit, Clean filter (Allergen clear filter x 1, Photocatalytic washable deodorizing filter x 1)			
Option parts			Interface kit (SC-BIKN-E)			
Note (1) The data are measured at the following conditions.			The pipe length is 7.5m.			
Operation	Item	Indoor air temperature		Outdoor air temperature		Standards
		DB	WB	DB	WB	
	Cooling	27°C	19°C	35°C	24°C	
Heating	20°C	-	7°C	6°C		
(2) This air-conditioner is manufactured and tested in conformity with the ISO.						
(3) Sound level indicates the value in an anechoic chamber. During operation these value are somewhat higher due to ambient conditions.						
(4) Select the breaker size according to the own national standard.						

Item		Model		SRK35ZM-S	
				Indoor unit SRK35ZM-S	Outdoor unit SRC35ZM-S
Power source				Single phase, 220 - 240V, 50Hz	
Operation data	Nominal cooling capacity (range)		kW	3.5 ( 1.0 (Min.) - 3.8 (Max.))	
	Nominal heating capacity (range)		kW	4.0 ( 1.3 (Min.) - 4.8 (Max.))	
	Power consumption	Cooling	kW	1.01 ( 0.21 - 1.24 )	
		Heating		1.00 ( 0.29 - 1.45 )	
	Max power consumption			1.65	
	Running current	Cooling	A	4.9 / 4.7 / 4.5 (220/ 230/ 240 V)	
		Heating		4.9 / 4.7 / 4.5 (220/ 230/ 240 V)	
	Inrush current, max current			4.9 / 4.7 / 4.5 (220/ 230/ 240 V) Max. 9	
	Power factor	Cooling	%	93.4	
		Heating		92.5	
	EER	Cooling		3.47	
	COP	Heating		4.00	
	Sound power level	Cooling	dB(A)	58	
		Heating		59	
Sound pressure level	Cooling	dB(A)	Hi: 42 Me: 32 Lo: 26 ULo: 22		
	Heating		Hi: 43 Me: 37 Lo: 25 ULo:22		
Silent mode sound pressure level			Cooling:45 / Heating:45		
Exterior dimensions (Height x Width x Depth)		mm	294 x 798 x 229		
Exterior appearance ( Munsell color )			Fine snow ( 8.0Y 9.3/0.1 ) near equivalent		
Net weight		kg	9.5		
Compressor type & Q'ty			—		
Compressor motor (Starting method)		kW	—		
Refrigerant oil (Amount, type)		ℓ	—		
Refrigerant (Type, amount, pre-charge length)		kg	R410A 1.05 in outdoor unit (incl. the amount for the piping of 15m )		
Heat exchanger			Louver fins & inner grooved tubing		
Refrigerant control			M fins & inner grooved tubing		
Fan type & Q'ty			Capillary tubes + Electronic expansion valve		
Fan motor (Starting method)		W	Tangential fan x 1		
Air flow	Cooling	m <sup>3</sup> /min	Propeller fan x 1		
	Heating		30 x1 (Direct drive)		
Available external static pressure		Pa	24 x1 (Direct drive)		
Outside air intake			Hi: 10.1 Me: 6.4 Lo: 5.4 ULo: 5.0		
Air filter, Quality / Quantity			Hi: 12.8 Me: 9.4 Lo: 6.1 ULo: 4.8		
Shock & vibration absorber			0		
Electric heater			0		
Operation control	Remote control		Wireless remote control		
	Room temperature control		Microcomputer thermostat		
	Operation display		RUN: Green, TIMER: Yellow, HI POWER: Green, 3D AUTO: Green		
Safety equipments			Compressor overheat protection, Overcurrent protection, Frost protection, Serial signal error protection, Indoor fan motor error protection, Heating overload protection (High pressure control), Cooling overload protection		
Installation data	Refrigerant piping size (O.D)	mm	Liquid line : ϕ 6.35 (1/4") Gas line : ϕ 9.52 (3/8")		
	Connecting method		Flare connection		
	Attached length of piping	m	Liquid line : 0.53 / Gas line : 0.40		
	Insulation for piping		Necessary (Both sides), independent		
	Refrigerant line (one way) length	m	Max. 15		
	Vertical height diff. between O.U. and I.U.	m	Max. 10 (Outdoor unit is higher) / Max. 10 (Outdoor unit is lower)		
Drain hose			Hose connectable ( VP 16 )		
Drain pump, max lift height		mm	—		
Recommended breaker size		A	16		
L.R.A. (Locked rotor ampere)		A	4.9 / 4.7 / 4.5 (220/ 230/ 240 V)		
Interconnecting wires		Size x Core number	1.5mm <sup>2</sup> x 4 cores (Including earth cable) / Terminal block (Screw fixing type)		
IP number			IPX0		
Standard accessories			IPX4		
Option parts			Mounting kit, Clean filter (Allergen clear filter x 1, Photocatalytic washable deodorizing filter x 1)		
			Interface kit (SC-BIKN-E)		
Note (1) The data are measured at the following conditions.				The pipe length is 7.5m.	
Operation	Item	Indoor air temperature		Outdoor air temperature	
		DB	WB	DB	WB
	Cooling	27°C	19°C	35°C	24°C
Heating	20°C	—	7°C	6°C	
(2) This air-conditioner is manufactured and tested in conformity with the ISO.					
(3) Sound level indicates the value in an anechoic chamber. During operation these value are somewhat higher due to ambient conditions.					
(4) Select the breaker size according to the own national standard.					

Item		Model		SRK50ZM-S		
				Indoor unit SRK50ZM-S	Outdoor unit SRC50ZM-S	
Power source				Single phase, 220 - 240V, 50Hz		
Operation data	Nominal cooling capacity (range)		kW	5.0 ( 1.6 (Min.) - 5.5 (Max.))		
	Nominal heating capacity (range)		kW	5.8 ( 1.6 (Min.) - 6.6 (Max.))		
	Power consumption	Cooling	kW	1.55 ( 0.40 - 2.20 )		
		Heating		1.59 ( 0.42 - 2.10 )		
	Max power consumption			2.68		
	Running current	Cooling	A	7.1 / 6.8 / 6.5 (220/ 230/ 240 V)		
		Heating		7.3 / 7.0 / 6.7 (220/ 230/ 240 V)		
	Inrush current, max current			7.3 / 7.0 / 6.7 (220/ 230/ 240 V) Max. 14		
	Power factor	Cooling	%	99		
		Heating		99		
	EER	Cooling		3.23		
	COP	Heating		3.65		
	Sound power level	Cooling	dB(A)	60		
		Heating		61		
Sound pressure level	Cooling		Hi: 46 Me: 37 Lo: 28 ULo: 25			
	Heating		Hi: 45 Me: 37 Lo: 31 ULo:27			
Silent mode sound pressure level			Cooling:43 / Heating:45			
Exterior dimensions (Height x Width x Depth)		mm	294 x 798 x 229			
Exterior appearance ( Munsell color )			Fine snow ( 8.0Y 9.3/0.1 ) near equivalent			
Net weight		kg	9.5			
Compressor type & Q'ty			—			
Compressor motor (Starting method)		kW	—			
Refrigerant oil (Amount, type)		ℓ	—			
Refrigerant (Type, amount, pre-charge length)		kg	R410A 1.35 in outdoor unit (incl. the amount for the piping of 15m )			
Heat exchanger			Louver fins & inner grooved tubing			
Refrigerant control			M fins & inner grooved tubing			
Fan type & Q'ty			Capillary tubes + Electronic expansion valve			
Fan motor (Starting method)		W	Tangential fan x 1			
Air flow		m <sup>3</sup> /min	Propeller fan x 1			
Available external static pressure		Pa	30 x1 (Direct drive)			
Outside air intake			34 x1 (Direct drive)			
Air filter, Quality / Quantity			Hi: 11.3 Me: 7.8 Lo: 6.0 ULo: 5.3			
Shock & vibration absorber			Hi: 13.5 Me: 10.2 Lo: 7.5 ULo: 6.2			
Electric heater			0			
Operation control			Not possible			
Remote control			Polypropylene net ( washable ) x 2			
Room temperature control			Rubber sleeve (for fan motor)			
Operation display			Rubber sleeve (for fan motor & compressor)			
Safety equipments			—			
Refrigerant piping size (O.D)		mm	Wireless remote control			
Connecting method			Microcomputer thermostat			
Attached length of piping		m	RUN: Green, TIMER: Yellow, HI POWER: Green, 3D AUTO: Green			
Insulation for piping			Compressor overheat protection, Overcurrent protection, Frost protection, Serial signal error protection, Indoor fan motor error protection, Heating overload protection (High pressure control), Cooling overload protection			
Refrigerant line (one way) length		m	Liquid line : ϕ 6.35 (1/4") Gas line : ϕ 12.7 (1/2")			
Vertical height diff. between O.U. and I.U.		m	Flare connection			
Drain hose			Flare connection			
Drain pump, max lift height		mm	Liquid line : 0.53 / Gas line : 0.40			
Recommended breaker size		A	Necessary (Both sides), independent			
L.R.A. (Locked rotor ampere)		A	Max. 25			
Interconnecting wires		Size x Core number	Max. 15 (Outdoor unit is higher) / Max. 15 (Outdoor unit is lower)			
IP number			Hose connectable ( VP 16 )			
Standard accessories			Holes ϕ 20 x 5 pcs			
Option parts			16			
Note (1) The data are measured at the following conditions.			7.3 / 7.0 / 6.7 (220/ 230/ 240 V)			
			1.5mm <sup>2</sup> x 4 cores (Including earth cable) / Terminal block (Screw fixing type)			
			IPX0			
			IPX4			
			Mounting kit, Clean filter (Allergen clear filter x 1, Photocatalytic washable deodorizing filter x 1)			
			Interface kit (SC-BIKN-E)			
Note (1) The data are measured at the following conditions.			The pipe length is 7.5m.			
Operation	Item	Indoor air temperature		Outdoor air temperature		Standards
		DB	WB	DB	WB	
	Cooling	27°C	19°C	35°C	24°C	
Heating	20°C	—	7°C	6°C		
(2) This air-conditioner is manufactured and tested in conformity with the ISO.						
(3) Sound level indicates the value in an anechoic chamber. During operation these value are somewhat higher due to ambient conditions.						
(4) Select the breaker size according to the own national standard.						

## 2. EXTERIOR DIMENSIONS

### (1) Indoor units

Models SRK20ZM-S, 25ZM-S, 35ZM-S, 50ZM-S

Symbol	Content	
A	Gas piping	Model 20~35 : $\phi 9.52$ (3/8") (Flare) 50 : $\phi 12.7$ (1/2") (Flare)
B	Liquid piping	$\phi 6.35$ (1/4") (Flare)
C	Hole on wall for right rear piping	( $\phi 65$ )
D	Hole on wall for left rear piping	( $\phi 65$ )
E	Drain hose	VP16
F	Outlet for wiring	
G	Outlet for piping (on both side)	

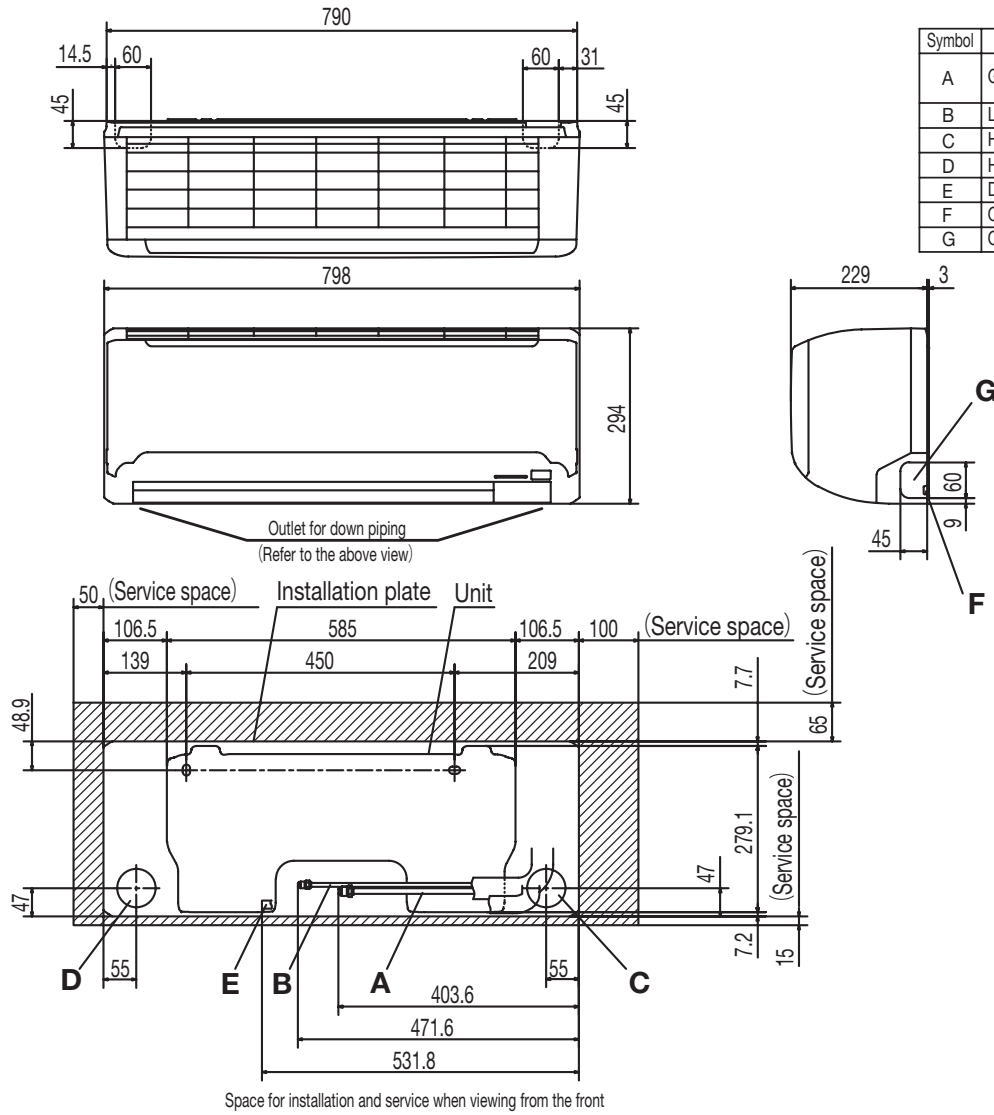

Wireless remote control

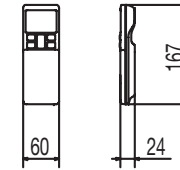

Wired - remote control  
(Option)

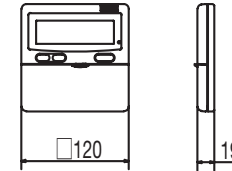

- Notes (1) The model name label is attached on the underside of the panel.  
 (2) It takes the interface kit (SC-BIKN-E) to connect the wired remote control.  
 Unit:mm

RLA000Z054

(2) Outdoor units

Models SRC20ZM-S, 25ZM-S, 35ZM-S

Symbol	Content	
A	Service valve connection (gas side)	$\phi 9.52$ (3/8") (Flare)
B	Service valve connection (liquid side)	$\phi 6.35$ (1/4") (Flare)
C	Pipe / cable draw-out hole	
D	Drain discharge hole	$\phi 20 \times 2$ places
E	Anchor bolt hole	M10 $\times$ 4 places

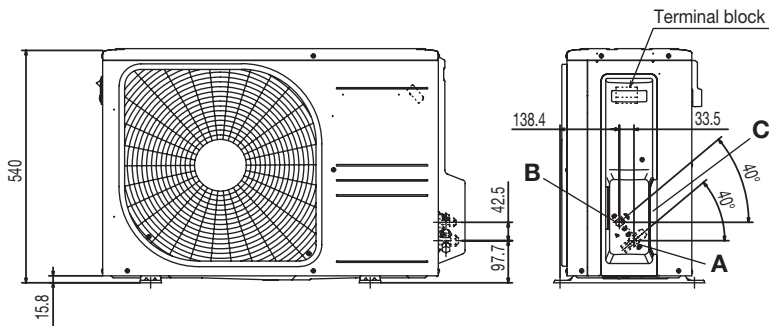
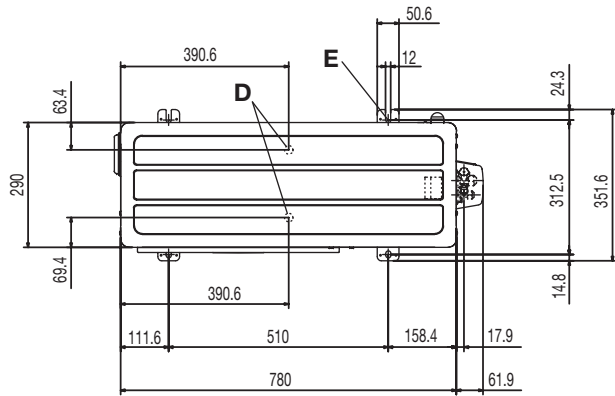

Notes

- (1) It must not be surrounded by walls on the four sides.
- (2) The unit must be fixed with anchor bolts. An anchor bolt must not protrude more than 15mm.
- (3) Where the unit is subject to strong winds, lay it in such a direction that the blower outlet faces perpendicularly to the dominant wind direction.
- (4) Leave 1m or more space above the unit.
- (5) A wall in front of the blower outlet must not exceed the units height.
- (6) The model name label is attached on the right side of the unit.

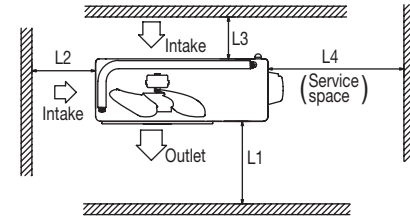

Minimum installation space

Dimensions	Examples of installation			
	I	II	III	IV
L1	Open	280	280	180
L2	100	75	Open	Open
L3	100	80	80	80
L4	250	Open	250	Open

Unit:mm

RCV000Z019

RCT000Z009

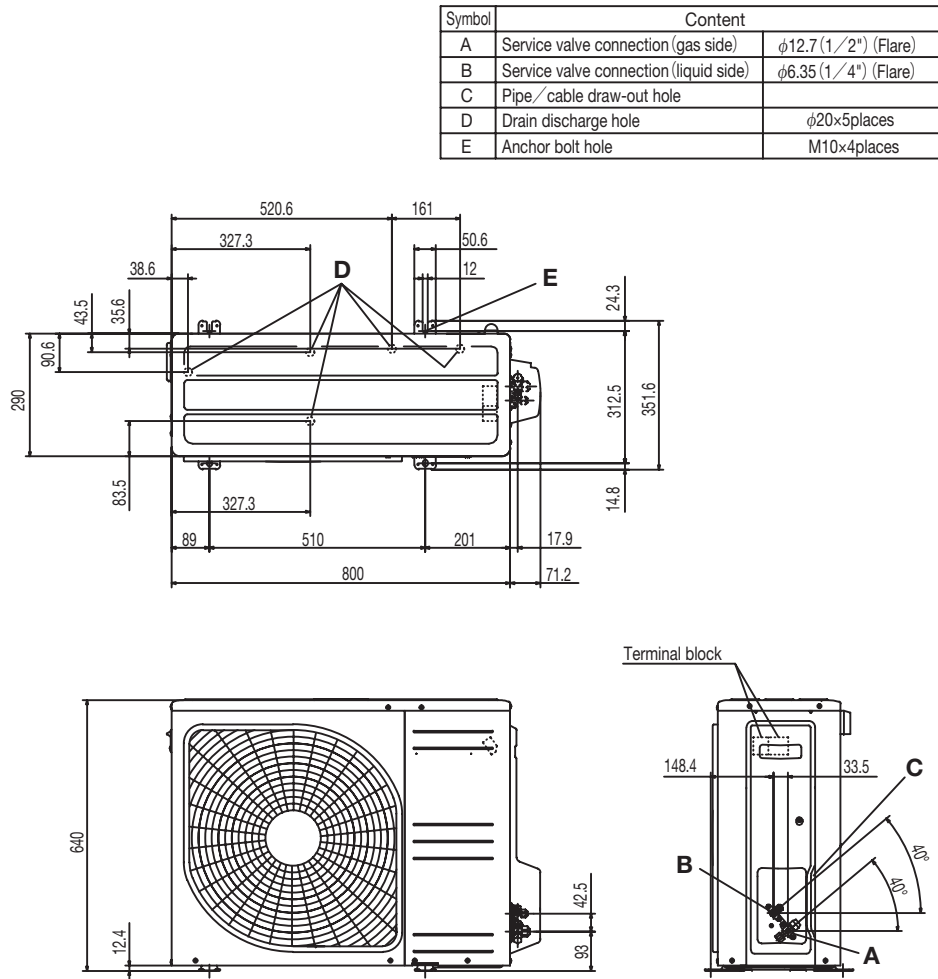

Notes

- (1) It must not be surrounded by walls on the four sides.
- (2) The unit must be fixed with anchor bolts. An anchor bolt must not protrude more than 15mm.
- (3) Where the unit is subject to strong winds, lay it in such a direction that the blower outlet faces perpendicularly to the dominant wind direction.
- (4) Leave 1m or more space above the unit.
- (5) A wall in front of the blower outlet must not exceed the units height.
- (6) The model name label is attached on the right side of the unit.

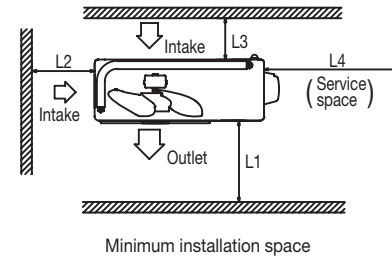

Dimensions	Examples of installation			
	I	II	III	IV
L1	Open	280	280	180
L2	100	75	Open	Open
L3	100	80	80	80
L4	250	Open	250	Open

Unit:mm

Models SRC50ZM-S



(3) Remote control  
(a) Wireless remote control

Unit : mm

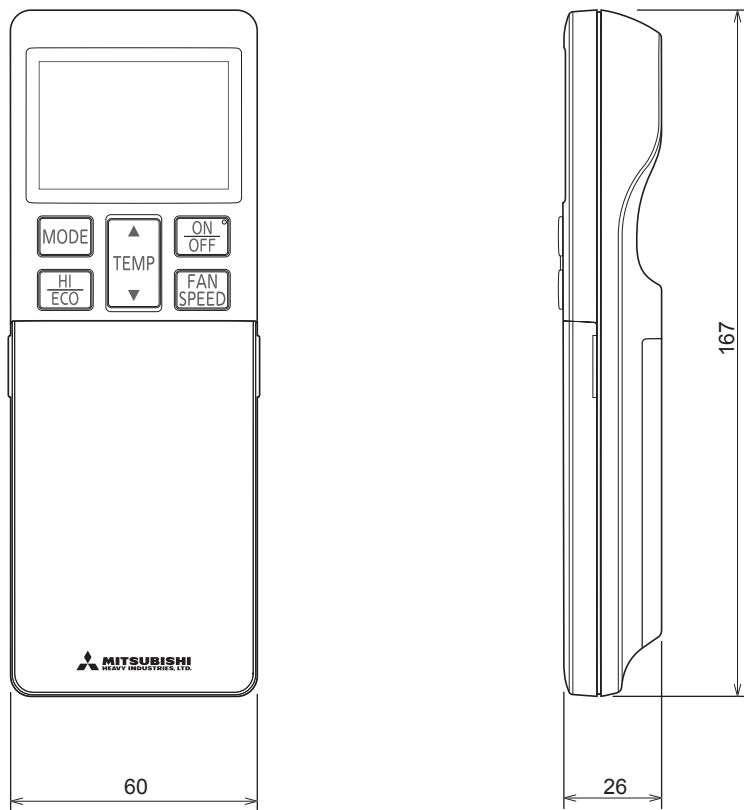

**(b) Wired remote control (option parts)**

**Interface kit (SC-BIKN-E) is required to use the wired remote control.**

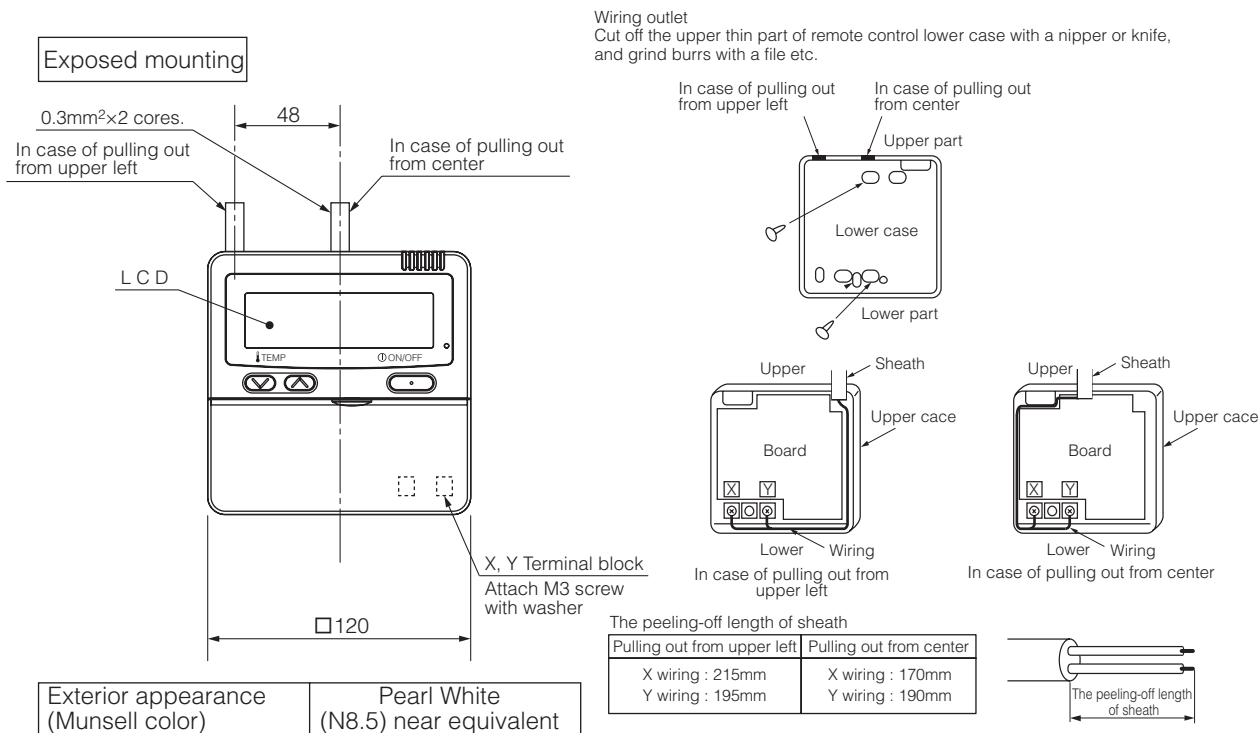

**Embedded mounting**

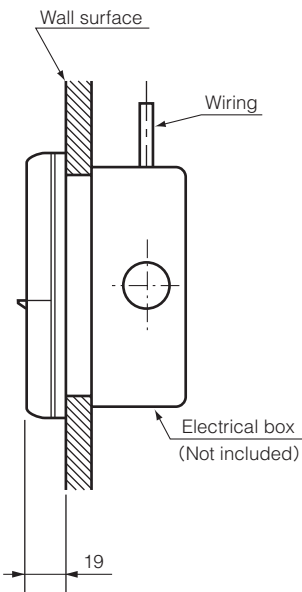

**Remote control installation dimensions**

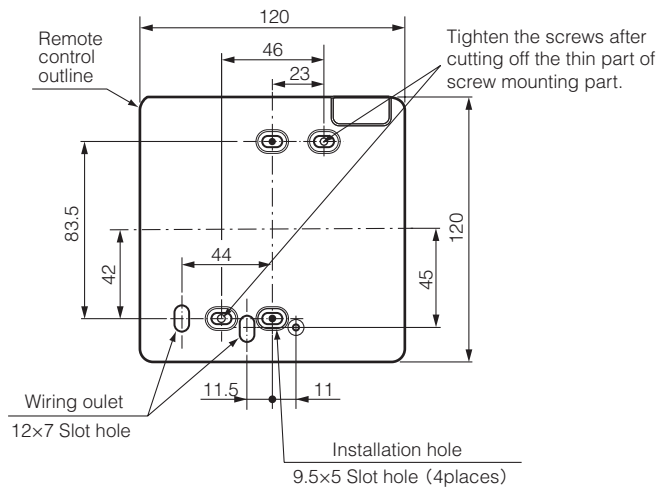

(1) Installation screw for remote control  
M4 Screw (2 pieces)

Unit:mm

**Wiring specifications**

(1) If the prolongation is over 100m, change to the size below.  
But, wiring in the remote control case should be under 0.5mm<sup>2</sup>. Change the wire size outside of the case according to wire connecting. Waterproof treatment is necessary at the wire connecting section. Be careful about contact failure.

Length	Wiring thickness
100 to 200m	0.5mm <sup>2</sup> ×2 cores
Under 300m	0.75mm <sup>2</sup> ×2 cores
Under 400m	1.25mm <sup>2</sup> ×2 cores
Under 600m	2.0mm <sup>2</sup> ×2 cores

PJZ000Z295

### 3. ELECTRICAL WIRING

(1) Indoor units

Models SRK20ZM-S, 25ZM-S, 35ZM-S, 50ZM-S

Item	Description
CNE-CNY	Connector
FM <sub>i</sub>	Fan motor
SM <sub>i</sub>	Flap motor
LM <sub>1,2</sub>	Louver motor
HD	Humidity sensor
Th <sub>1</sub>	Room temp. sensor
Th <sub>2,3</sub>	Heat exch. sensor
DS	Diode stack
F	Fuse
T	Terminal block
Va	Varistor

Mark	Color
BK	Black
BL	Blue
RD	Red
WH	White
Y	Yellow
Y/G	Yellow/Green

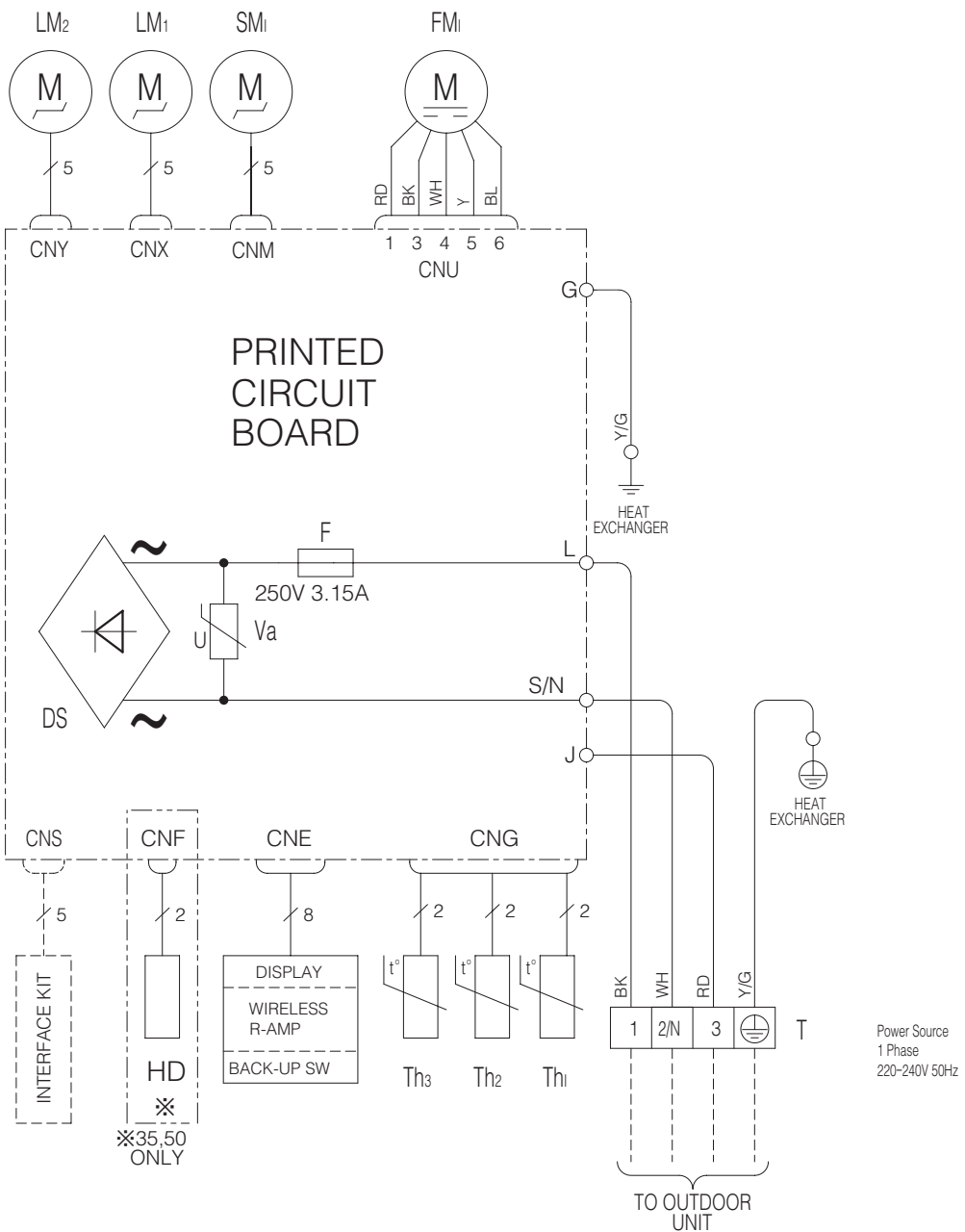

Power Source  
1 Phase  
220-240V 50Hz

(2) Outdoor units

Models SRC20ZM-S, 25ZM-S, 35ZM-S

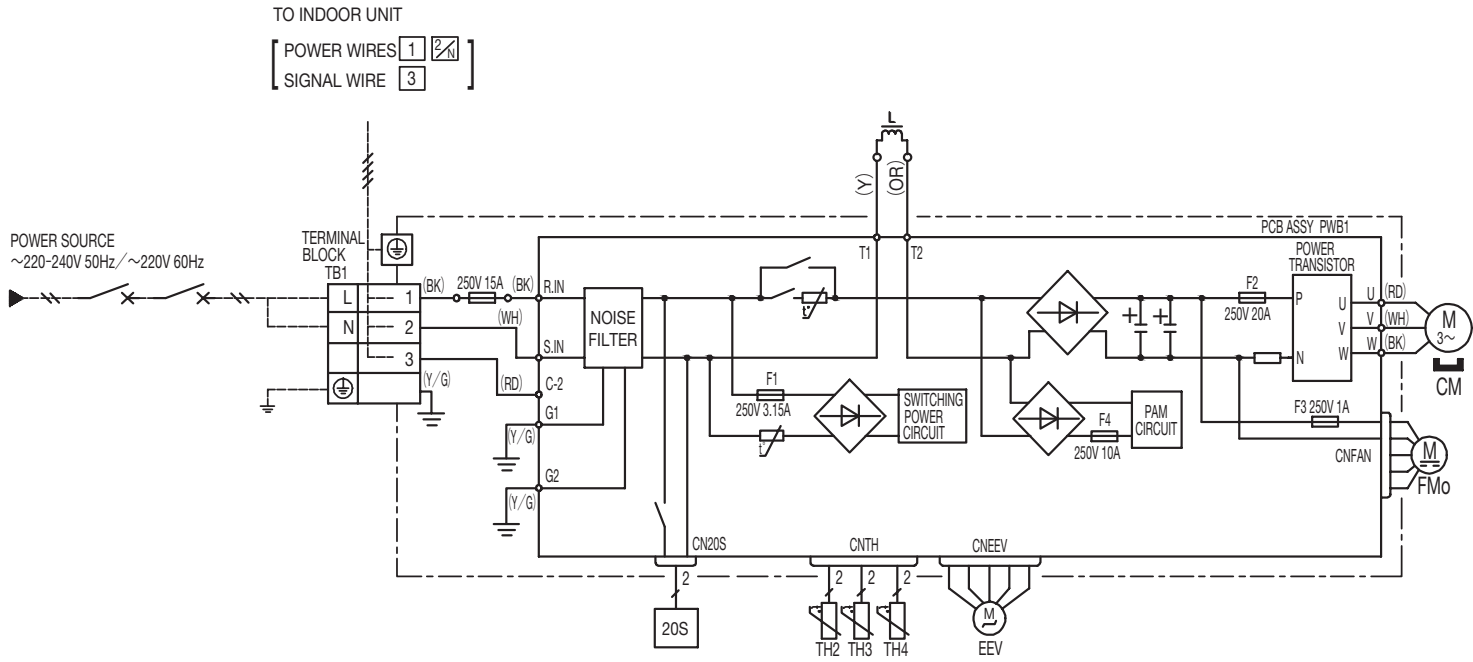

Power cable, indoor-outdoor connecting wires

Model	MAX running current (A)	Power cable size (mm <sup>2</sup> )	Power cable length (m)	indoor-outdoor wire size x number	Earth wire size (mm <sup>2</sup> )
20	9	2.0	32	1.5mm <sup>2</sup> x 3	1.5
25					
35					

- The specifications shown in the above table are for units without heaters. For units with heaters, refer to the installation instructions or the construction instructions of the indoor unit.
- Switchgear of Circuit breaker capacity which is calculated from MAX. over current should be chosen along the regulations in each country.
- The cable specifications are based on the assumption that a metal or plastic conduit is used with no more than three cables contained in a conduit and a voltage drop is 2%. For an installation falling outside of these conditions, please follow the internal cabling regulations. Adapt it to the regulation in effect in each country.

Item	Description
CM	Compressor motor
CN20S	Connector
CNTH	
CNEEV	
CNFAN	
EEV	Electric expansion valve (coil)
FMo	Fan motor
L	Reactor
TB1	Terminal block
TH2	Heat exchanger sensor (outdoor unit)
TH3	Outdoor air temp.sensor
TH4	Discharge pipe temp.sensor
20S	Solenoid valve for 4 way valve

Mark	Color
BK	Black
OR	Orange
RD	Red
WH	White
Y	Yellow
Y/G	Yellow/Green

RWC000Z272

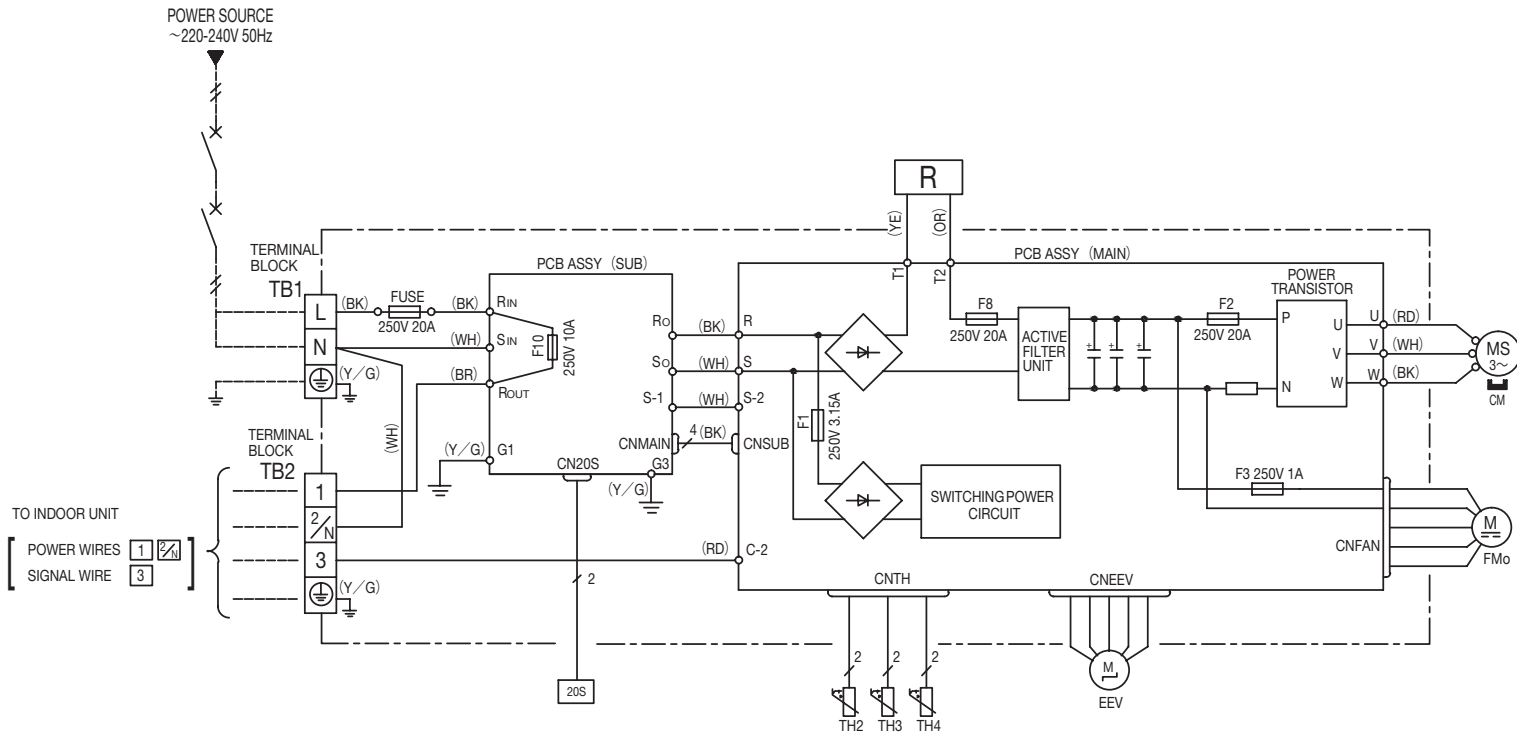

Power cable, indoor-outdoor connecting wires

Model	MAX running current (A)	Power cable size (mm <sup>2</sup> )	Power cable length (m)	indoor-outdoor wire size x number	Earth wire size (mm <sup>2</sup> )
50	14	2.0	18	1.5mm <sup>2</sup> x 3	1.5

- The specifications shown in the above table are for units without heaters. For units with heaters, refer to the installation instructions or the construction instructions of the indoor unit.
- Switchgear of Circuit breaker capacity which is calculated from MAX. over current should be chosen along the regulations in each country.
- The cable specifications are based on the assumption that a metal or plastic conduit is used with no more than three cables contained in a conduit and a voltage drop is 2%. For an installation falling outside of these conditions, please follow the internal cabling regulations. Adapt it to the regulation in effect in each country.

Item	Description
CM	Compressor motor
CNEEV~CN20S	Connector
EEV	Electric expansion valve (coil)
FMo	Fan motor
R	Reactor
TB1,2	Terminal block
TH2	Heat exchanger sensor (outdoor unit)
TH3	Outdoor air temp.sensor
TH4	Discharge pipe temp.sensor
20S	Solenoid valve for 4 way valve

Mark	Color
BK	Black
BR	Brown
OR	Orange
RD	Red
WH	White
YE	Yellow
Y/G	Yellow/Green

RWC000Z269

# 4. NOISE LEVEL

Model SRK20ZM-S

Condition ISO-T1, JIS C 9612

(Indoor Unit)

Model	SRK20ZM-S	
Noise Level	Cooling	33 dB(A)
	Heating	36 dB(A)

●Mike position



× ..... Cooling ○ — Heating

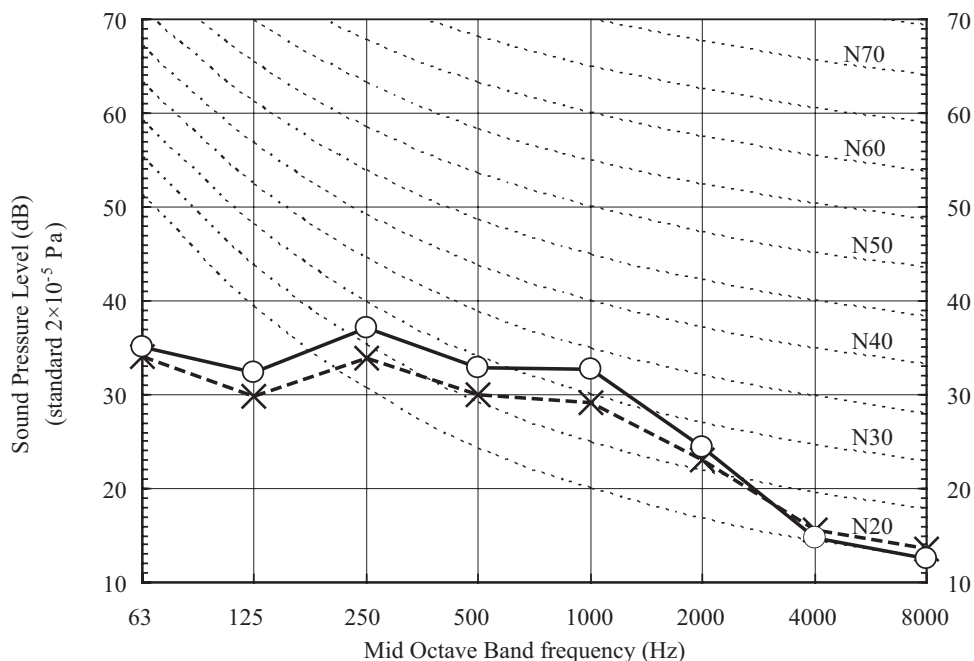

(Outdoor Unit)

Model	SRC20ZM-S	
Noise Level	Cooling	47 dB(A)
	Heating	46 dB(A)

●Mike position: at highest noise level in position as mentioned below  
Distance from front side 1m

× ..... Cooling ○ — Heating

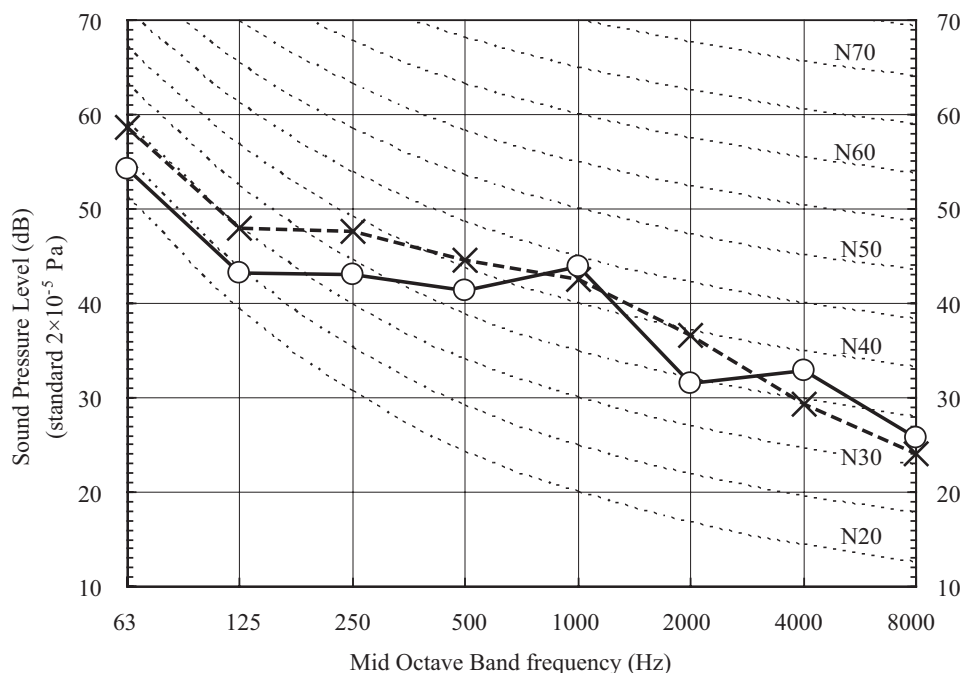

**Model SRK25ZM-S**

(Indoor Unit)

Model	SRK25ZM-S	
Noise Level	Cooling	34 dB(A)
	Heating	39 dB(A)

Condition ISO-T1, JIS C 9612

●Mike position



× ..... Cooling ○ — Heating

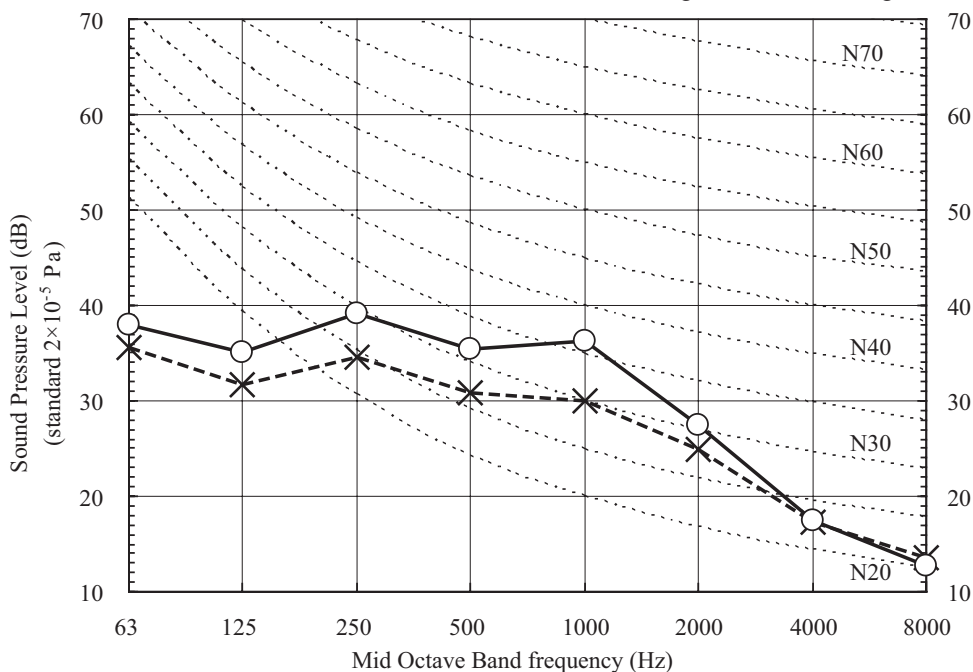

(Outdoor Unit)

Model	SRC25ZM-S	
Noise Level	Cooling	48 dB(A)
	Heating	49 dB(A)

●Mike position: at highest noise level in position as mentioned below  
Distance from front side 1m

× ..... Cooling ○ — Heating

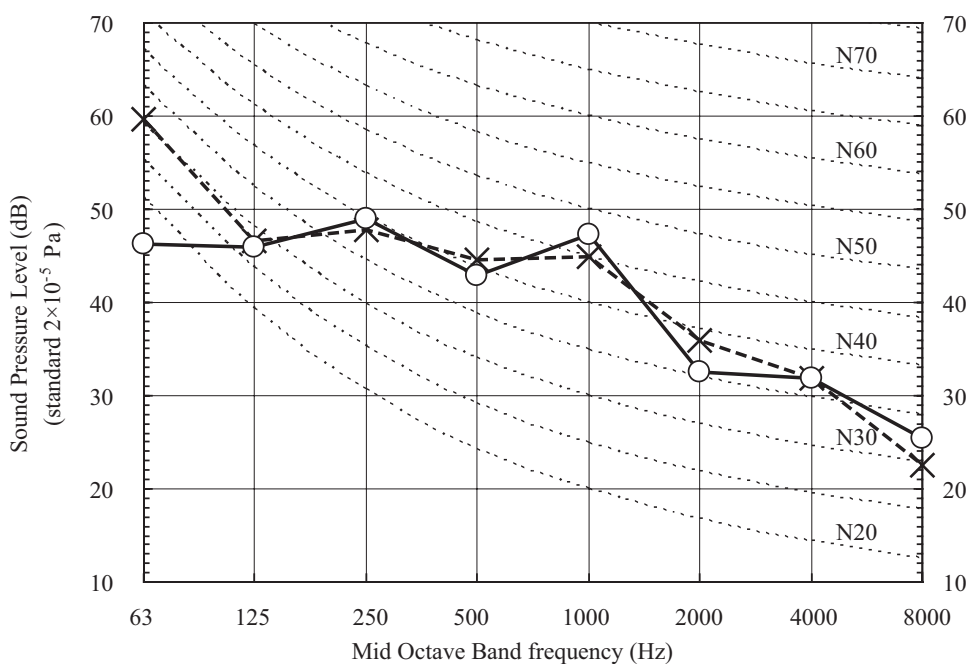

**Model SRK35ZM-S**

(Indoor Unit)

Model	SRK35ZM-S	
Noise Level	Cooling	42 dB(A)
	Heating	43 dB(A)

Condition ISO-T1, JIS C 9612

●Mike position

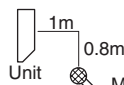

Mike position (Center & Low points)

× ..... Cooling ○ — Heating

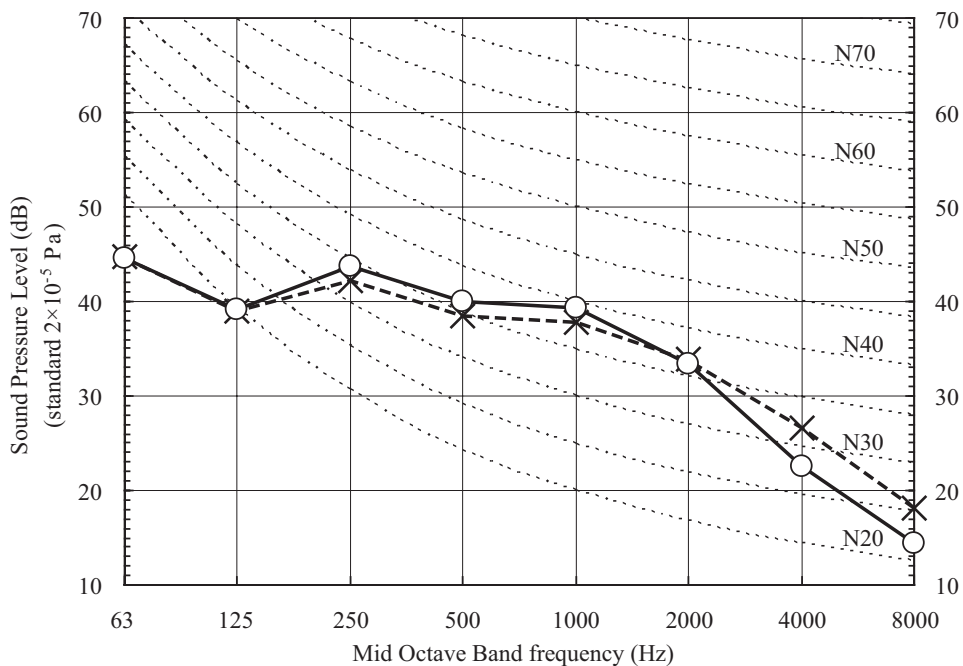

(Outdoor Unit)

Model	SRC35ZM-S	
Noise Level	Cooling	50 dB(A)
	Heating	51 dB(A)

●Mike position: at highest noise level in position as mentioned below  
Distance from front side 1m

× ..... Cooling ○ — Heating

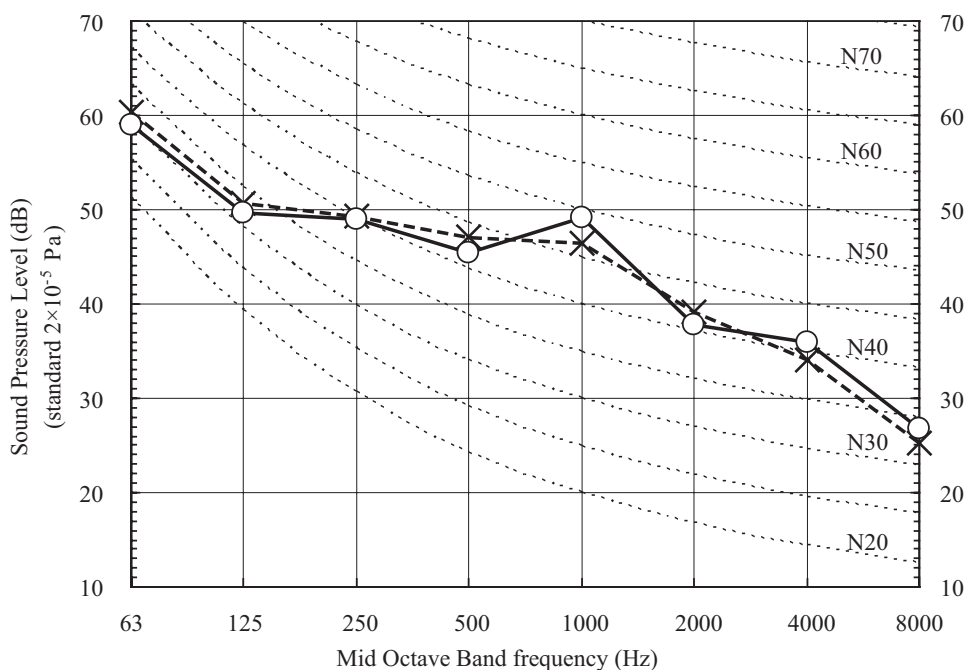



**Model SRK50ZM-S**

(Indoor Unit)

Model	SRK50ZM-S	
Noise Level	Cooling	46 dB(A)
	Heating	45 dB(A)

Condition ISO-T1, JIS C 9612

● Mike position



× ..... Cooling ○ — Heating

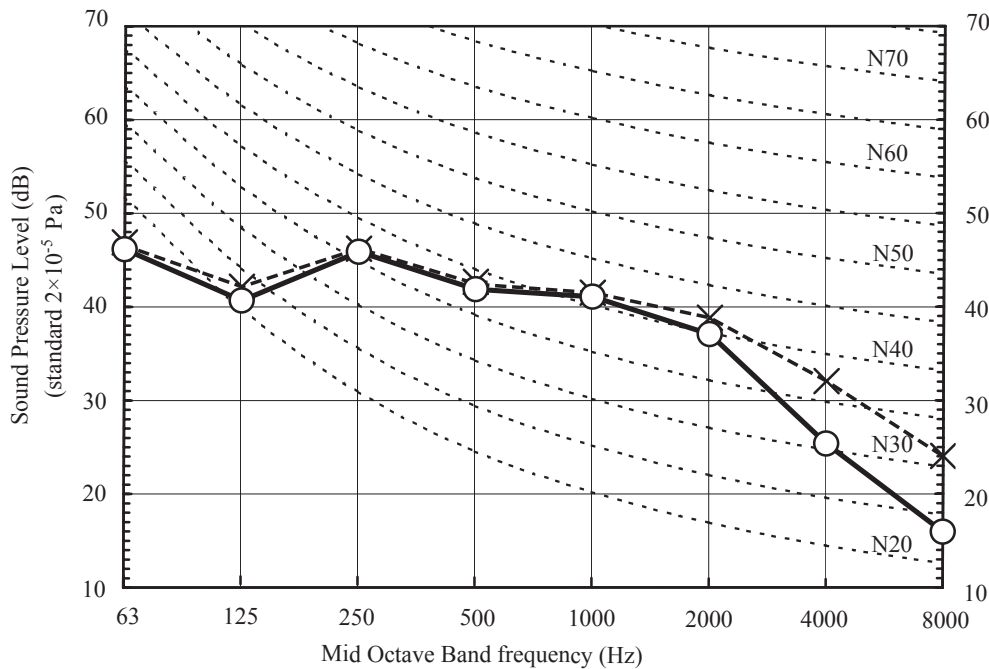

(Outdoor Unit)

Model	SRC50ZM-S	
Noise Level	Cooling	51 dB(A)
	Heating	53 dB(A)

● Mike position: at highest noise level in position as mentioned below  
Distance from front side 1m

× ..... Cooling ○ — Heating

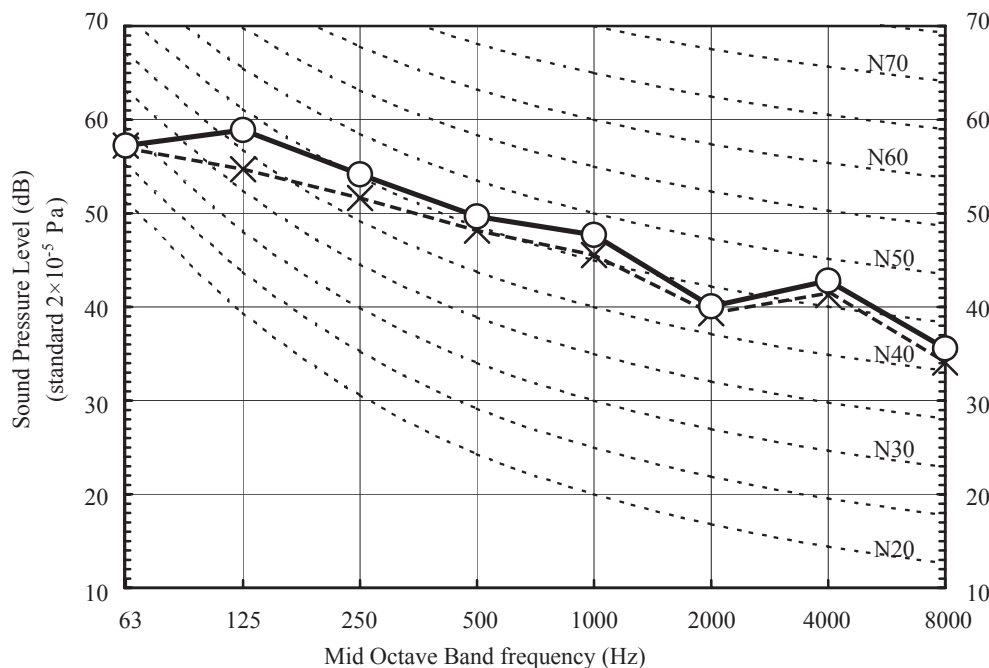

# 5. PIPING SYSTEM

Models SRK20ZM-S, 25ZM-S

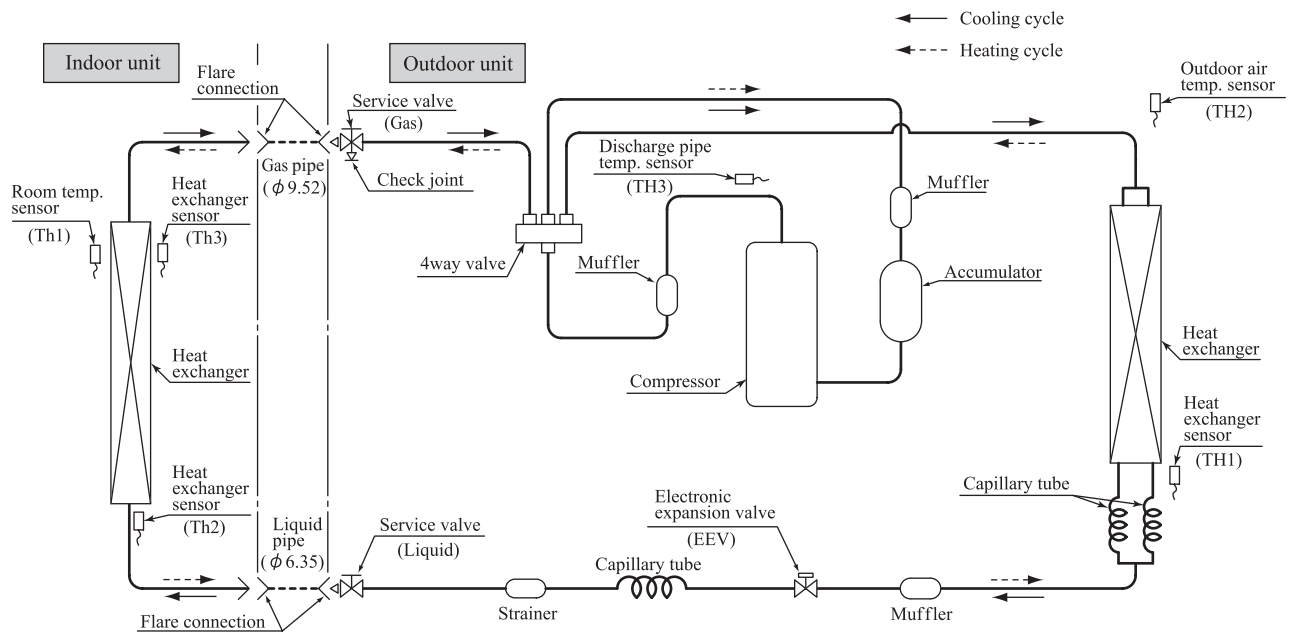

## Model SRK35ZM-S

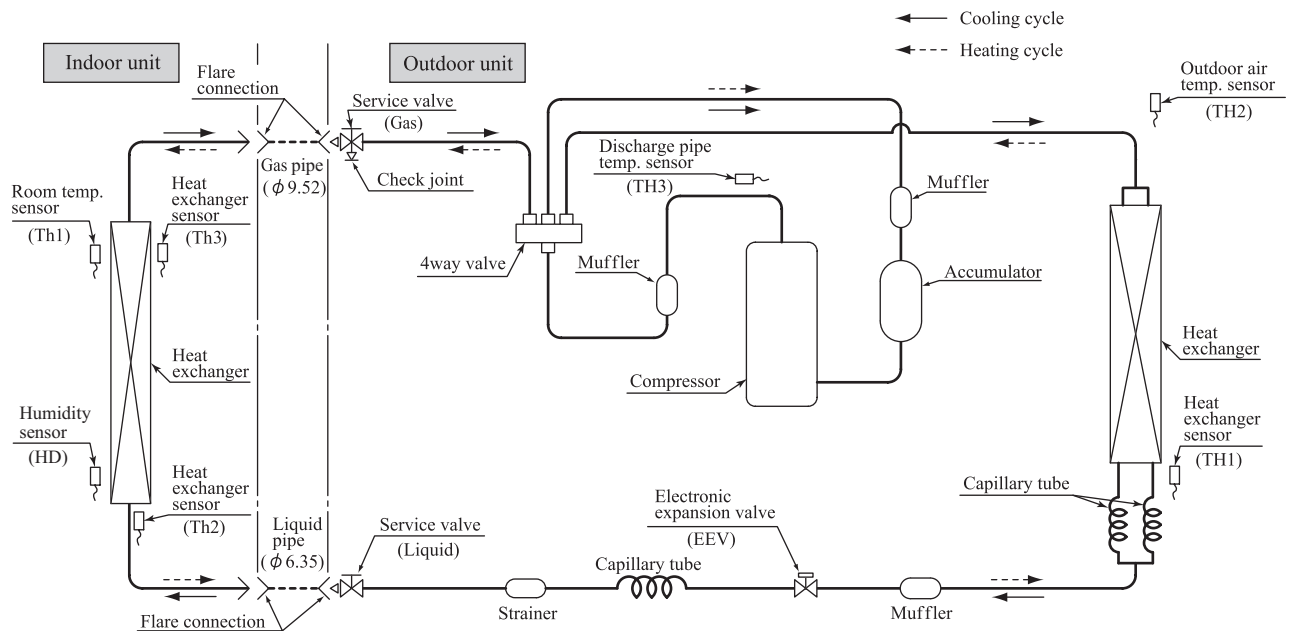

Model SRK50ZM-S

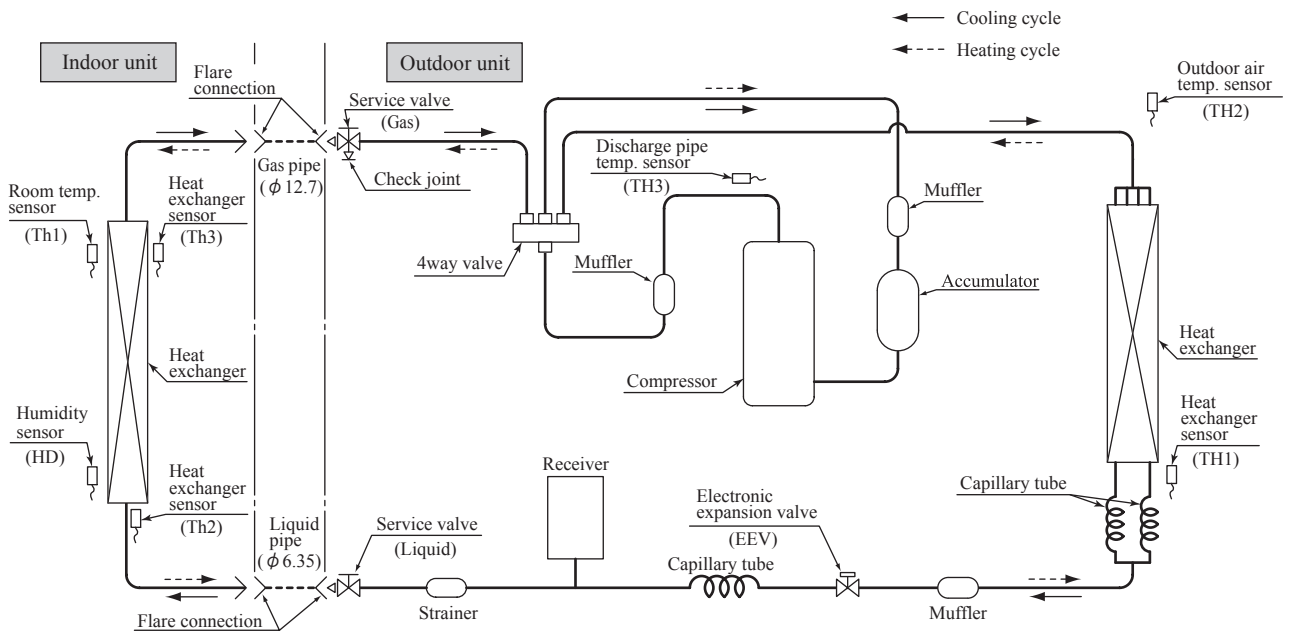

## 6. RANGE OF USAGE & LIMITATIONS

Models	SRK20,25,35ZM-S	SRK50ZM-S
Item		
Indoor return air temperature (Upper, lower limits)	Cooling operation : Approximately 18 to 32°C D.B. Heating operation : Approximately 10 to 30°C D.B. (Refer to the selection chart)	
Outdoor air temperature (Upper, lower limits)	Cooling operation : Approximately -15 to 46°C D.B. Heating operation : Approximately -15 to 24°C D.B. (Refer to the selection chart)	
Refrigerant line (one way) length	Max. 15m	Max. 25m
Vertical height difference between outdoor unit and indoor unit	Max. 10m (Outdoor unit is higher) Max. 10m (Outdoor unit is lower)	Max. 15m (Outdoor unit is higher) Max. 15m (Outdoor unit is lower)
Power source voltage	Rating ± 10%	
Voltage at starting	Min. 85% of rating	
Frequency of ON-OFF cycle	Max. 4 times/h (Inching prevention 10 minutes)	Max. 7 times/h (Inching prevention 5 minutes)
ON and OFF interval	Min. 3 minutes	

### Selection chart

Correct the cooling and heating capacity in accordance with the conditions as follows. The net cooling and heating capacity can be obtained in the following way.

**Net capacity = Capacity shown on specification × Correction factors as follows.**

#### (1) Coefficient of cooling and heating capacity in relation to temperatures

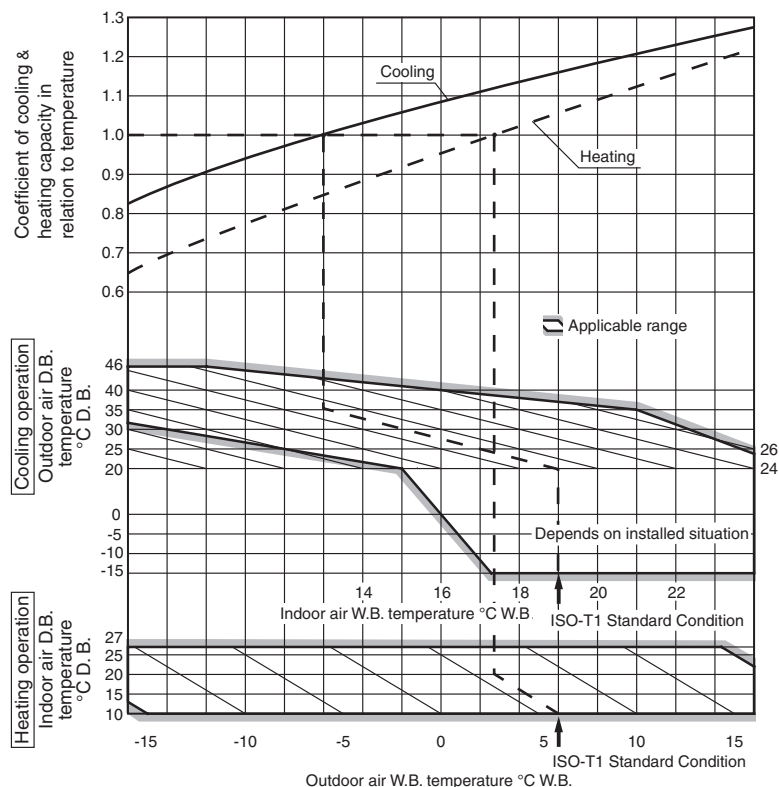

**(2) Correction of cooling and heating capacity in relation to one way length of refrigerant piping**

It is necessary to correct the cooling and heating capacity in relation to the one way piping length between the indoor and outdoor units.

Piping length [m]	7	10	15	20	25	30
Cooling	1.0	0.99	0.975	0.965	0.95	0.935
Heating	1.0	1.0	1.0	1.0	1.0	1.0

**(3) Correction relative to frosting on outdoor heat exchanger during heating**

In additions to the foregoing corrections (1), (2) the heating capacity needs to be adjusted also with respect to the frosting on the outdoor heat exchanger.

Air inlet temperature of outdoor unit in °CWB	-15	-10	-9	-7	-5	-3	-1	1	3	5 or more
Adjustment coefficient	0.95	0.95	0.94	0.93	0.91	0.88	0.86	0.87	0.92	1.00

**How to obtain the cooling and heating capacity**

Example : The net cooling capacity of the model SRK35ZM-S with the piping length of 15m, indoor wet-bulb temperature at 19.0°C and outdoor dry-bulb temperature 35°C is Net cooling capacity =

$$\begin{array}{ccccccc}
 \frac{3.5}{\uparrow} & \times & \frac{0.975}{\uparrow} & \times & \frac{1.0}{\uparrow} & \cong & 3.4 \text{ kW} \\
 \text{SRK35ZM-S} & & \text{Length 15m} & & \text{Factor by air} & & \\
 & & & & \text{temperatures} & & 
 \end{array}$$

# 7. CAPACITY TABLES

**Model SRK20ZM-S** Cooling Mode (kW)

Air flow	Outdoor air temp.	Indoor air temp													
		21°CDB		23°CDB		26°CDB		27°CDB		28°CDB		31°CDB		33°CDB	
		14°CWB	16°CWB	18°CWB	19°CWB	20°CWB	22°CWB	24°CWB	TC	SHC	TC	SHC	TC	SHC	TC
Hi 7.8 (m³/min)	10	2.25	1.93	2.36	1.90	2.45	1.99	2.49	1.96	2.53	1.94	2.60	2.02	2.67	1.97
	12	2.21	1.91	2.32	1.88	2.41	1.97	2.45	1.95	2.50	1.93	2.58	2.01	2.65	1.96
	14	2.17	1.89	2.28	1.86	2.38	1.96	2.42	1.94	2.47	1.91	2.55	2.00	2.62	1.95
	16	2.13	1.87	2.24	1.85	2.34	1.94	2.39	1.92	2.43	1.90	2.52	1.99	2.59	1.94
	18	2.08	1.85	2.19	1.82	2.30	1.92	2.35	1.90	2.40	1.88	2.49	1.98	2.56	1.93
	20	2.04	1.83	2.15	1.81	2.26	1.91	2.31	1.89	2.36	1.87	2.45	1.97	2.53	1.92
	22	1.99	1.81	2.10	1.78	2.22	1.89	2.28	1.88	2.32	1.86	2.42	1.95	2.50	1.91
	24	1.94	1.78	2.05	1.76	2.18	1.88	2.24	1.86	2.28	1.85	2.38	1.94	2.47	1.90
	26	1.90	1.76	2.01	1.74	2.14	1.86	2.20	1.85	2.24	1.83	2.35	1.93	2.43	1.89
	28	1.85	1.74	1.96	1.72	2.09	1.84	2.15	1.83	2.20	1.82	2.31	1.92	2.40	1.88
	30	1.79	1.70	1.90	1.70	2.05	1.83	2.11	1.82	2.16	1.80	2.27	1.90	2.36	1.87
	32	1.74	1.65	1.85	1.68	2.00	1.81	2.07	1.80	2.12	1.79	2.23	1.89	2.32	1.86
	34	1.69	1.60	1.80	1.65	1.95	1.79	2.02	1.78	2.07	1.77	2.19	1.88	2.28	1.85
	35	1.66	1.58	1.77	1.64	1.93	1.78	2.00	1.78	2.05	1.76	2.17	1.87	2.26	1.84
	36	1.63	1.55	1.74	1.62	1.90	1.77	1.98	1.77	2.02	1.75	2.15	1.87	2.24	1.83
	38	1.58	1.50	1.68	1.60	1.85	1.75	1.93	1.75	1.98	1.74	2.11	1.85	2.20	1.82
	39	1.55	1.47	1.66	1.57	1.83	1.74	1.91	1.74	1.95	1.73	2.08	1.84	2.18	1.81

Heating Mode (HC) (kW)

Air flow	outdoor air temp.	Indoor air temp				
		16°CDB	18°CDB	20°CDB	22°CDB	24°CDB
		Hi 9.8 (m³/min)	-15°CWB	1.66	1.63	1.59
-10°CWB	1.88		1.85	1.82	1.78	1.74
-5°CWB	2.04		2.01	1.97	1.94	1.91
0°CWB	2.13		2.10	2.07	2.04	2.01
5°CWB	2.72		2.69	2.67	2.62	2.58
6°CWB	2.76		2.73	2.70	2.67	2.63
10°CWB	2.94		2.91	2.89	2.85	2.82
15°CWB	3.20		3.17	3.14	3.11	3.08
20°CWB	3.43	3.41	3.39	3.35	3.32	

**Model SRK25ZM-S** Cooling Mode (kW)

Air flow	Outdoor air temp.	Indoor air temp													
		21°CDB		23°CDB		26°CDB		27°CDB		28°CDB		31°CDB		33°CDB	
		14°CWB	16°CWB	18°CWB	19°CWB	20°CWB	22°CWB	24°CWB	TC	SHC	TC	SHC	TC	SHC	TC
Hi 7.9 (m³/min)	10	2.82	2.23	2.95	2.19	3.06	2.27	3.11	2.24	3.16	2.21	3.26	2.28	3.34	2.21
	12	2.77	2.20	2.90	2.17	3.01	2.25	3.07	2.22	3.12	2.20	3.22	2.27	3.31	2.20
	14	2.71	2.17	2.85	2.14	2.97	2.23	3.03	2.21	3.08	2.18	3.18	2.25	3.28	2.19
	16	2.66	2.15	2.80	2.12	2.92	2.21	2.98	2.19	3.04	2.16	3.15	2.24	3.24	2.18
	18	2.60	2.12	2.74	2.09	2.88	2.19	2.94	2.17	2.99	2.14	3.11	2.22	3.20	2.17
	20	2.55	2.09	2.68	2.07	2.83	2.17	2.89	2.14	2.95	2.12	3.07	2.21	3.17	2.15
	22	2.49	2.06	2.63	2.04	2.78	2.14	2.84	2.12	2.90	2.10	3.02	2.20	3.13	2.14
	24	2.43	2.03	2.57	2.01	2.72	2.12	2.80	2.11	2.85	2.08	2.98	2.18	3.08	2.13
	26	2.37	2.00	2.51	1.98	2.67	2.10	2.74	2.09	2.80	2.07	2.93	2.16	3.04	2.11
	28	2.31	1.97	2.44	1.96	2.61	2.08	2.69	2.07	2.75	2.05	2.89	2.14	3.00	2.10
	30	2.24	1.94	2.38	1.92	2.56	2.05	2.64	2.05	2.70	2.03	2.84	2.13	2.95	2.08
	32	2.18	1.91	2.31	1.89	2.50	2.03	2.58	2.03	2.64	2.01	2.79	2.11	2.90	2.07
	34	2.11	1.88	2.25	1.87	2.44	2.01	2.53	2.00	2.59	1.99	2.74	2.09	2.85	2.05
	35	2.08	1.87	2.21	1.85	2.41	1.99	2.50	1.99	2.56	1.97	2.71	2.08	2.83	2.04
	36	2.04	1.85	2.18	1.84	2.38	1.98	2.47	1.98	2.53	1.96	2.69	2.08	2.80	2.03
	38	1.97	1.82	2.11	1.81	2.32	1.96	2.41	1.96	2.47	1.94	2.63	2.05	2.75	2.02
	39	1.94	1.80	2.07	1.79	2.28	1.94	2.38	1.94	2.44	1.93	2.61	2.05	2.72	2.01

Heating Mode (HC) (kW)

Air flow	outdoor air temp.	Indoor air temp				
		16°CDB	18°CDB	20°CDB	22°CDB	24°CDB
		Hi 10.6 (m³/min)	-15°CWB	1.97	1.93	1.88
-10°CWB	2.23		2.19	2.16	2.10	2.06
-5°CWB	2.41		2.38	2.33	2.30	2.27
0°CWB	2.53		2.49	2.45	2.42	2.38
5°CWB	3.22		3.19	3.17	3.10	3.06
6°CWB	3.27		3.24	3.20	3.16	3.12
10°CWB	3.48		3.45	3.42	3.38	3.34
15°CWB	3.79		3.75	3.73	3.69	3.65
20°CWB	4.07	4.04	4.02	3.97	3.94	

**Model SRK35ZM-S** Cooling Mode (kW)

Air flow	Outdoor air temp.	Indoor air temp													
		21°CDB		23°CDB		26°CDB		27°CDB		28°CDB		31°CDB		33°CDB	
		14°CWB	16°CWB	18°CWB	19°CWB	20°CWB	22°CWB	24°CWB	TC	SHC	TC	SHC	TC	SHC	TC
Hi 10.1 (m³/min)	10	3.94	3.00	4.13	2.95	4.28	3.04	4.35	3.00	4.43	2.97	4.56	3.04	4.68	2.94
	12	3.87	2.97	4.06	2.92	4.22	3.02	4.29	2.98	4.37	2.94	4.51	3.02	4.63	2.93
	14	3.80	2.93	3.99	2.88	4.16	2.99	4.24	2.96	4.31	2.91	4.46	3.00	4.59	2.91
	16	3.72	2.89	3.91	2.85	4.09	2.96	4.18	2.93	4.25	2.89	4.40	2.98	4.54	2.89
	18	3.65	2.85	3.84	2.81	4.03	2.93	4.11	2.90	4.19	2.87	4.35	2.96	4.49	2.88
	20	3.57	2.81	3.76	2.77	3.96	2.90	4.05	2.87	4.13	2.84	4.29	2.94	4.43	2.85
	22	3.49	2.77	3.68	2.73	3.89	2.86	3.98	2.83	4.06	2.80	4.23	2.92	4.38	2.84
	24	3.40	2.72	3.59	2.69	3.81	2.83	3.91	2.81	3.99	2.78	4.17	2.89	4.32	2.81
	26	3.32	2.68	3.51	2.65	3.74	2.80	3.84	2.78	3.92	2.75	4.11	2.86	4.26	2.80
	28	3.23	2.63	3.42	2.61	3.66	2.77	3.77	2.76	3.85	2.72	4.04	2.84	4.20	2.77
	30	3.14	2.59	3.33	2.57	3.58	2.74	3.70	2.72	3.78	2.70	3.98	2.82	4.13	2.75
	32	3.05	2.54	3.24	2.52	3.50	2.70	3.62	2.69	3.70	2.66	3.91	2.79	4.06	2.73
	34	2.95	2.50	3.14	2.48	3.41	2.66	3.54	2.66	3.62	2.63	3.84	2.77	4.00	2.69
	35	2.91	2.48	3.10	2.46	3.37	2.65	3.50	2.64	3.58	2.62	3.80	2.75	3.96	2.68
	36	2.86	2.46	3.05	2.44	3.33	2.63	3.46	2.63	3.54	2.60	3.76	2.72	3.92	2.67
	38	2.76	2.41	2.95	2.40	3.24	2.59	3.38	2.59	3.46	2.57	3.69	2.70	3.85	2.65
	39	2.71	2.39	2.90	2.37	3.20	2.57	3.33	2.58	3.42	2.56	3.65	2.69	3.81	2.64

Heating Mode (HC) (kW)

Air flow	outdoor air temp.	Indoor air temp				
		16°CDB	18°CDB	20°CDB	22°CDB	24°CDB
		Hi 12.8 (m³/min)	-15°CWB	2.46	2.41	2.35
-10°CWB	2.79		2.74	2.70	2.63	2.58
-5°CWB	3.02		2.97	2.91	2.88	2.83
0°CWB	3.16		3.12	3.06	3.02	2.98
5°CWB	4.03		3.98	3.96	3.88	3.83
6°CWB	4.09		4.04	4.00	3.95	3.90
10°CWB	4.35		4.31	4.28	4.22	4.18
15°CWB	4.73		4.69	4.66	4.61	4.56
20°CWB	5.09	5.05	5.02	4.96	4.92	

Note(1) These data show average statuses.  
Depending on the system control, there may be ranges where the operation is not conducted continuously.  
These data show the case where the operation frequency of a compressor is fixed.  
(2) Capacities are based on the following conditions.  
Corresponding refrigerant piping length :7m  
Level difference of Zero.  
(3) Symbols are as follows.  
TC : Total cooling capacity (kW)  
SHC : Sensible heat capacity (kW)  
HC : Heating capacity (kW)

**Model SRK50ZM-S**

Cooling Mode

(kW)

Air flow	Outdoor air temp.	Indoor air temp													
		21°CDB		23°CDB		26°CDB		27°CDB		28°CDB		31°CDB		33°CDB	
		14°CWB	16°CWB	18°CWB	19°CWB	20°CWB	22°CWB	24°CWB	TC	SHC	TC	SHC	TC	SHC	TC
Hi 11.3 (m <sup>3</sup> /min)	10	5.63	4.09	5.90	4.02	6.11	4.12	6.22	4.05	6.32	3.99	6.51	4.05	6.69	3.92
	12	5.53	4.03	5.80	3.97	6.03	4.07	6.14	4.01	6.25	3.96	6.44	4.02	6.62	3.89
	14	5.43	3.98	5.70	3.91	5.94	4.03	6.05	3.98	6.16	3.92	6.37	4.00	6.55	3.86
	16	5.32	3.92	5.59	3.86	5.85	3.98	5.96	3.93	6.08	3.88	6.29	3.96	6.48	3.84
	18	5.21	3.85	5.48	3.80	5.75	3.94	5.88	3.90	5.99	3.84	6.21	3.93	6.41	3.81
	20	5.10	3.79	5.37	3.74	5.65	3.89	5.78	3.85	5.90	3.80	6.13	3.90	6.33	3.78
	22	4.98	3.73	5.25	3.68	5.55	3.84	5.69	3.81	5.80	3.76	6.05	3.86	6.25	3.75
	24	4.86	3.67	5.14	3.62	5.45	3.79	5.59	3.76	5.71	3.72	5.96	3.83	6.17	3.72
	26	4.74	3.60	5.01	3.56	5.34	3.74	5.49	3.71	5.61	3.67	5.87	3.79	6.08	3.69
	28	4.61	3.54	4.89	3.50	5.23	3.69	5.39	3.67	5.50	3.63	5.78	3.76	5.99	3.66
	30	4.49	3.46	4.76	3.43	5.11	3.64	5.28	3.62	5.40	3.58	5.68	3.72	5.90	3.62
	32	4.35	3.40	4.63	3.37	5.00	3.58	5.17	3.57	5.29	3.54	5.58	3.68	5.81	3.59
	34	4.22	3.33	4.49	3.31	4.88	3.52	5.06	3.52	5.18	3.49	5.48	3.64	5.71	3.55
	35	4.15	3.29	4.42	3.27	4.82	3.49	5.00	3.49	5.12	3.45	5.43	3.62	5.66	3.53
	36	4.08	3.26	4.35	3.24	4.76	3.47	4.94	3.46	5.06	3.43	5.37	3.60	5.61	3.50
	38	3.94	3.19	4.21	3.18	4.63	3.42	4.82	3.42	4.94	3.39	5.27	3.54	5.50	3.47
	39	3.87	3.15	4.14	3.14	4.57	3.39	4.76	3.39	4.88	3.36	5.21	3.52	5.45	3.45

Heating Mode (HC)

(kW)

Air flow	outdoor air temp.	indoor air temp				
		16°CDB	18°CDB	20°CDB	22°CDB	24°CDB
		Hi 13.5 (m <sup>3</sup> /min)	-15°CWB	3.57	3.49	3.41
-10°CWB	4.04		3.97	3.91	3.81	3.73
-5°CWB	4.37		4.31	4.22	4.18	4.11
0°CWB	4.59		4.52	4.44	4.39	4.32
5°CWB	5.84		5.77	5.74	5.63	5.55
6°CWB	5.94		5.87	5.80	5.73	5.66
10°CWB	6.31		6.25	6.21	6.12	6.06
15°CWB	6.86		6.80	6.76	6.68	6.62
20°CWB	7.38	7.32	7.28	7.20	7.14	

Note(1) These data show average statuses.  
Depending on the system control, there may be ranges where the operation is not conducted continuously.  
These data show the case where the operation frequency of a compressor is fixed.

(2) Capacities are based on the following conditions.  
Corresponding refrigerant piping length :7m  
Level difference of Zero.

(3) Symbols are as follows.  
TC : Total cooling capacity (kW)  
SHC : Sensible heat capacity (kW)  
HC : Heating capacity (kW)

# 8. APPLICATION DATA

## (1) Installation of indoor unit

Models SRK20ZM-S, 25ZM-S, 35ZM-S, 50ZM-S

RLA012A020

- This installation manual illustrates the method of installing an indoor unit.
- For electrical wiring work, please see instructions set out on the backside.
- For outdoor unit installation and refrigerant piping, please refer to page 29.

- A wired remote control unit is supplied separately as an optional part.
- When install the unit, be sure to check whether the selection of installation place, power supply specifications, usage limitation (piping length, height differences between indoor and outdoor units, power supply voltage and etc.) and installation spaces.

### SAFETY PRECAUTIONS

- Read the "SAFETY PRECAUTIONS" carefully first of all and strictly follow it during the installation work in order to protect yourself.
- The precautionary items mentioned below are distinguished into two levels, **WARNING** and **CAUTION**.
  - **WARNING**: Wrong installation would cause serious consequences such as injuries or death.
  - **CAUTION**: Wrong installation might cause serious consequences depending on circumstances.
- Both mentions the important items to protect your health and safety so strictly follow them by any means.
- Be sure to confirm no anomaly on the equipment by commissioning after completed installation and explain the operating methods as well as the maintenance methods of this equipment to the user according to the owner's manual.

- Keep the installation manual together with owner's manual at a place where any user can read at any time. Moreover if necessary, ask to hand them to a new user.
- For installing qualified personnel, take precautions in respect to themselves by using suitable protective clothing, gloves, etc., and then perform the installation works.
- Please pay attention not to fall down the tools, etc. when installing the unit at the high position.
- If unusual noise can be heard during operation, consult the dealer.
- The meanings of "Marks" used here are shown as follows:

	Never do it under any circumstances.		Always do it according to the instruction.
---	--------------------------------------	---	--

<b>WARNING</b>	
<ul style="list-style-type: none"> <li>• <b>Installation must be carried out by the qualified installer.</b> If you install the system by yourself, it may cause serious trouble such as water leaks, electric shocks, fire and personal injury, as a result of a system malfunction. Do not carry out the installation and maintenance work except the by qualified installer.</li> <li>• <b>Install the system in full accordance with the installation manual.</b> Incorrect installation may cause bursts, personal injury, water leaks, electric shocks and fire.</li> <li>• <b>Be sure to use only for household and residence.</b> If this appliance is installed in inferior environment such as machine shop and etc., it can cause malfunction.</li> <li>• <b>Use the original accessories and the specified components for installation.</b> If parts other than those prescribed by us are used, It may cause water leaks, electric shocks, fire and personal injury.</li> <li>• <b>Install the unit in a location with good support.</b> Unsuitable installation locations can cause the unit to fall and cause material damage and personal injury.</li> <li>• <b>Ventilate the working area well in the event of refrigerant leakage during installation.</b> If the refrigerant comes into contact with naked flames, poisonous gas is produced.</li> <li>• <b>When installing in small rooms, take prevention measures not to exceed the density limit of refrigerant in the event of leakage, referred by the formula (accordance with ISO5149).</b> If the density of refrigerant exceeds the limit, please consult the dealer and install the ventilation system, otherwise lack of oxygen can occur, which can cause serious accident.</li> <li>• <b>After completed installation, check that no refrigerant leaks from the system.</b> If refrigerant leaks into the room and comes into contact with an oven or other hot surface, poisonous gas is produced.</li> <li>• <b>Use the prescribed pipes, flare nuts and tools for R410A.</b> Using existing parts (for R22 or R407C) can cause the unit failure and serious accidents due to burst of the refrigerant circuit.</li> </ul>	<ul style="list-style-type: none"> <li>• <b>Tighten the flare nut by torque wrench with specified method.</b> If the flare nut were tightened with excess torque, this may cause burst and refrigerant leakage after a long period.</li> <li>• <b>The electrical installation must be carried out by the qualified electrician in accordance with "the norm for electrical work" and "national wiring regulation", and the system must be connected to the dedicated circuit.</b> Power supply with insufficient capacity and incorrect function done by improper work can cause electric shocks and fire.</li> <li>• <b>Be sure to shut off the power before starting electrical work.</b> Failure to shut off the power can cause electric shocks, unit failure or incorrect function of equipment.</li> <li>• <b>Be sure to use the cables conformed to safety standard and cable ampacity for power distribution work.</b> Unconformable cables can cause electric leak, anomalous heat production or fire.</li> <li>• <b>This appliance must be connected to main power supply by means of a circuit breaker or switch (fuse:16A) with a contact separation of at least 3mm.</b></li> <li>• <b>When plugging this appliance, a plug conforming to the norm IEC60884-1 must be used.</b></li> <li>• <b>Use the prescribed cables for electrical connection, tighten the cables securely in terminal block and relieve the cables correctly to prevent overloading the terminal blocks.</b> Loose connections or cable mountings can cause anomalous heat production or fire.</li> <li>• <b>Arrange the wiring in the control box so that it cannot be pushed up further into the box. Install the service panel correctly.</b> Incorrect installation may result in overheating and fire.</li> <li>• <b>Be sure to switch off the power supply in the event of installation, inspection or servicing.</b> If the power supply is not shut off, there is a risk of electric shocks, unit failure or personal injury due to the unexpected start of fan.</li> <li>• <b>Be sure to wear protective goggles and gloves while at work.</b></li> <li>• <b>Earth leakage breaker must be installed.</b> If the earth leakage breaker is not installed, it can cause electric shocks.</li> </ul>
<ul style="list-style-type: none"> <li>• <b>Do not put the drainage pipe directly into drainage channels where poisonous gases such as sulphide gas can occur.</b> Poisonous gases will flow into the room through drainage pipe and seriously affect the user's health and safety. This can also cause the corrosion of the indoor unit and a resultant unit failure or refrigerant leak.</li> <li>• <b>Ensure that no air enters in the refrigerant circuit when the unit is installed and removed.</b> If air enters in the refrigerant circuit, the pressure in the refrigerant circuit becomes too high, which can cause burst and personal injury.</li> </ul>	<ul style="list-style-type: none"> <li>• <b>Do not processing, splice the power cord, or share a socket with other power plugs.</b> This may cause fire or electric shock due to defecting contact, defecting insulation and over-current etc.</li> <li>• <b>Do not bundling, winding or processing for the power cord. Or, do not deforming the power plug due to tread it.</b> This may cause fire or heating.</li> </ul>

<b>WARNING</b>	
<ul style="list-style-type: none"> <li>• <b>Do not vent R410A into the atmosphere : R410A is a fluorinated greenhouse gas, covered by the Kyoto Protocol with Global Warming Potential (GWP)=1975.</b></li> <li>• <b>Do not run the unit with removed panels or protections.</b> Touching rotating equipments, hot surfaces or high voltage parts can cause personal injury due to entrapment, burn or electric shocks.</li> </ul>	<ul style="list-style-type: none"> <li>• <b>Do not perform any change of protective device itself or its setup condition.</b> The forced operation by short-circuiting protective device of pressure switch and temperature controller or the use of non specified component can cause fire or burst.</li> </ul>
<b>CAUTION</b>	
<ul style="list-style-type: none"> <li>• <b>Carry out the electrical work for ground lead with care.</b> Do not connect the ground lead to the gas line, water line, lightning conductor or telephone line's ground lead. Incorrect grounding can cause unit faults such as electric shocks due to short-circuiting.</li> </ul>	
<ul style="list-style-type: none"> <li>• <b>Use the circuit breaker of correct capacity. Circuit breaker should be the one that disconnect all poles under over current.</b> Using the incorrect one could cause the system failure and fire.</li> <li>• <b>Install isolator or disconnect switch on the power supply wiring in accordance with the local codes and regulations.</b> The isolator should be locked in OFF state in accordance with EN60204-1.</li> <li>• <b>Be sure to install indoor unit properly according to the installation manual in order to run off the drainage smoothly.</b> Improper installation of indoor unit can cause dropping water into the room and damaging personal property.</li> <li>• <b>Install the drainage pipe to run off drainage securely according to the installation manual.</b> Incorrect installation of the drainage pipe can cause dropping water into the room and damaging personal property.</li> <li>• <b>Be sure to install the drainage pipe with descending slope of 1/100 or more, and not to make traps and air-bleedings.</b> Check if the drainage runs off securely during commissioning and ensure the space for inspection and maintenance.</li> <li>• <b>Secure a space for installation, inspection and maintenance specified in the manual.</b> Insufficient space can result in accident such as personal injury due to</li> </ul>	<ul style="list-style-type: none"> <li>falling from the installation place.</li> <li>• <b>For installation work, be careful not to get injured with the heat exchanger, piping flare portion or screws etc.</b></li> <li>• <b>Be sure to insulate the refrigerant pipes so as not to condense the ambient air moisture on them.</b> Insufficient insulation can cause condensation, which can lead to moisture damage on the ceiling, floor, furniture and any other valuables.</li> <li>• <b>When perform the air conditioner operation (cooling or drying operation) in which ventilator is installed in the room. In this case, using the air conditioner in parallel with the ventilator, there is the possibility that drain water may backflow in accordance with the room lapse into the negative pressure status. Therefore, set up the opening port such as incorporate the air into the room that may appropriate to ventilation (For example; Open the door a little). In addition, just as above, so set up the opening port if the room lapse into negative pressure status due to register of the wind for the high rise apartment etc.</b></li> <li>• <b>Be sure to perform air tightness test by pressurizing with nitrogen gas after completed refrigerant piping work.</b> If the density of refrigerant exceeds the limit in the event of refrigerant leakage in the small room, lack of oxygen can occur, which can cause serious accidents.</li> </ul>
<ul style="list-style-type: none"> <li>• <b>Do not install the unit in the locations listed below.</b> <ul style="list-style-type: none"> <li>• Locations where carbon fiber, metal powder or any powder is floating.</li> <li>• Locations where any substances that can affect the unit such as sulphide gas, chloride gas, acid and alkaline can occur.</li> <li>• Vehicles and ships.</li> <li>• Locations where cosmetic or special sprays are often used.</li> <li>• Locations with direct exposure of oil mist and steam such as kitchen and machine plant.</li> <li>• Locations where any machines which generate high frequency harmonics are used.</li> <li>• Locations with salty atmospheres such as coastlines.</li> <li>• Locations with heavy snow (If installed, be sure to provide base flame and snow hood mentioned in the manual).</li> <li>• Locations where the unit is exposed to chimney smoke.</li> <li>• Locations at high altitude (more than 1000m high).</li> <li>• Locations with ammonic atmospheres.</li> <li>• Locations where heat radiation from other heat source can affect the unit.</li> <li>• Locations without good air circulation.</li> <li>• Locations with any obstacles which can prevent inlet and outlet air of the unit.</li> <li>• Locations where short circuit of air can occur (in case of multiple units installation).</li> <li>• Locations where strong air blows against the air outlet of outdoor unit.</li> <li>• Locations where something located above the unit could fall.</li> </ul> </li> <li>It can cause remarkable decrease in performance, corrosion and damage of components, malfunction and fire.</li> <li>• <b>Do not install the indoor unit in the locations listed below (Be sure to install the indoor unit according to the installation manual for each model because each indoor unit has each limitation).</b> <ul style="list-style-type: none"> <li>• Locations with any obstacles which can prevent inlet and outlet air of the unit.</li> <li>• Locations where vibration can be amplified due to insufficient strength of structure.</li> <li>• Locations where the infrared receiver is exposed to the direct sunlight or the strong light beam (in case of the infrared specification unit).</li> <li>• Locations where an equipment affected by high harmonics is placed (TV set or radio receiver is placed within 1m).</li> <li>• Locations where drainage cannot run off safely.</li> </ul> </li> <li>It can affect performance or function and etc.</li> <li>• <b>Do not install the unit near the location where leakage of combustible gases can occur.</b></li> </ul>	<ul style="list-style-type: none"> <li>If leaked gases accumulate around the unit, it can cause fire.</li> <li>• <b>Do not install the unit where corrosive gas (such as sulfurous acid gas etc.) or combustible gas (such as thinner and petroleum gases) can accumulate or collect, or where volatile combustible substances are handled.</b> Corrosive gas can cause corrosion of heat exchanger, breakage of plastic parts and etc. And combustible gas can cause fire.</li> <li>• <b>Do not use the indoor unit at the place where water splashes may occur such as in laundries.</b> Since the indoor unit is not waterproof, it can cause electric shocks and fire.</li> <li>• <b>Do not install nor use the system close to the equipment that generates electromagnetic fields or high frequency harmonics.</b> Equipment such as inverters, standby generators, medical high frequency equipments and telecommunication equipments can affect the system, and cause malfunctions and breakdowns. The system can also affect medical equipment and telecommunication equipment, and obstruct its function or cause jamming.</li> <li>• <b>Do not place any variables which will be damaged by getting wet under the indoor unit.</b> When the relative humidity is higher than 80% or drainage pipe is clogged, condensation or drainage water can drop and it can cause the damage of valuables.</li> <li>• <b>Do not install the wireless remote control at the direct sunlight.</b> It can cause malfunction or deformation of the wireless remote control.</li> <li>• <b>Do not use the unit for special purposes such as storing foods, cooling precision instruments and preservation of animals, plants or art.</b> It can cause the damage of the items.</li> <li>• <b>Do not use any materials other than a fuse with the correct rating in the location where fuses are to be used.</b> Connecting the circuit with copper wire or other metal thread can cause unit failure and fire.</li> <li>• <b>Do not touch any buttons with wet hands.</b> It can cause electric shocks.</li> <li>• <b>Do not touch any refrigerant pipes with your hands when the system is in operation.</b> During operation the refrigerant pipes become extremely hot or extremely cold depending the operating condition, and it can cause burn injury or frost injury.</li> </ul>



## BEFORE INSTALLATION

- Before installation check that the power supply matches the air conditioner.

Standard accessories (Installation kit) Accessories for indoor unit		Q'ty
①	Installation board (Attached to the rear of the indoor unit)	1
②	Wireless remote control	1
③	Remote control holder	1
④	Tapping screws (for installation board ø4 X 25mm)	5
⑤	Wood screws (for remote control holder ø3.5 X 16mm)	2
⑥	Battery [R03 (AAA, Micro) 1.5V]	2
⑦	Air-cleaning filters	2
⑧	Filter holders (Attached to the front panel of indoor unit)	2
⑨	Insulation (#486 50 x 100 t3)	1

Option parts		Q'ty
a	Sealing plate	1
b	Sleeve	1
c	Inclination plate	1
d	Putty	1
e	Drain hose (extension hose)	1
f	Piping cover (for insulation of connection piping)	1

Necessary tools for the installation work	
1	Plus headed driver
2	Knife
3	Saw
4	Tape measure
5	Hammer
6	Spanner wrench
7	Torque wrench (14.0 ~ 61.0N·m (1.4 ~ 6.1kgf·m))
8	Hole core drill (65mm in diameter)
9	Wrench key (Hexagon) [4m/m]
10	Flaring tool set (Designed specifically for R410A)
11	Gas leak detector (Designed specifically for R410A)
12	Gauge for projection adjustment (Used when flare is made by using conventional flare tool)
13	Pipe bender

## SELECTION OF INSTALLATION LOCATION

(Install at location that meets the following conditions, after getting approval from the customer)

### Indoor unit

- Where there is no obstructions to the air flow and where the cooled and heated air can be evenly distributed.
- A solid place where the unit or the wall will not vibrate.
- A place where there will be enough space for servicing. (Where space mentioned below can be secured)
- Where wiring and the piping work will be easy to conduct.
- The place where receiving part is not exposed to the direct rays of the sun or the strong rays of the street lighting.
- A place where it can be easily drained.
- A place separated at least 1m away from the television or the radio. (To prevent interference to images and sounds.)
- Places where this unit is not affected by the high frequency equipment or electric equipment.
- Avoid installing this unit in place where there is much oil mist.
- Places where there is no electric equipment or household under the installing unit.

### Wireless remote control

- A place where the air conditioner can be received the signal surely during operating the wireless remote control.
- Places where there is no affected by the TV and radio etc.
- Do not place where exposed to direct sunlight or near heat devices such as a stove.

## INSTALLATION OF INDOOR UNIT

### Installation of installation board

Look for the inside wall structures (Intermediats support or pillar and firmly install the unit after level surface has been checked.)

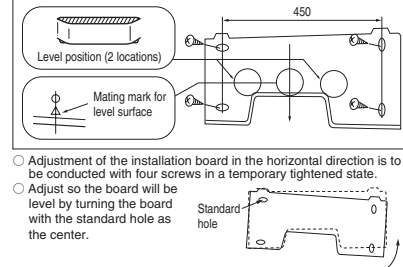

- Adjustment of the installation board in the horizontal direction is to be conducted with four screws in a temporary tightened state.
- Adjust so the board will be level by turning the board with the standard hole as the center.

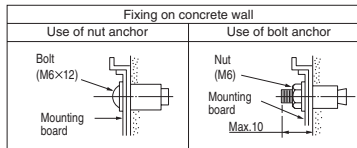

### Drilling of holes and fixture of sleeve (Option parts)

When drilling the wall that contains a metal lath, wire lath or metal plate, be sure to use pipe hole sleeve sold separately.

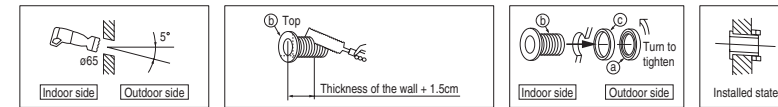

- Drill a hole with whole core drill.
- In case of rear piping draw out, cut off the lower and the right side portions of the sleeve collar.

### Installing the support of piping

#### In case of piping in the right rear direction

Shaping of pipings      Taping of the exterior

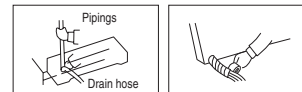

- Hold the bottom of the piping and fix direction before stretching it and shaping it.
- Tape only the portion that goes through the wall.
- Always tape the wiring with the piping.

Sufficient care must be taken not to damage the panel when connecting pipes.

• Matters of special notice when piping from left or central/rear of the unit.  
(Top view)

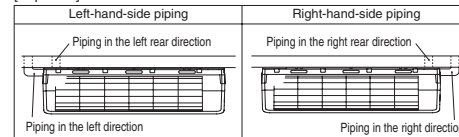

Piping is possible in the rear, left, left rear, left downward, right or downward direction.

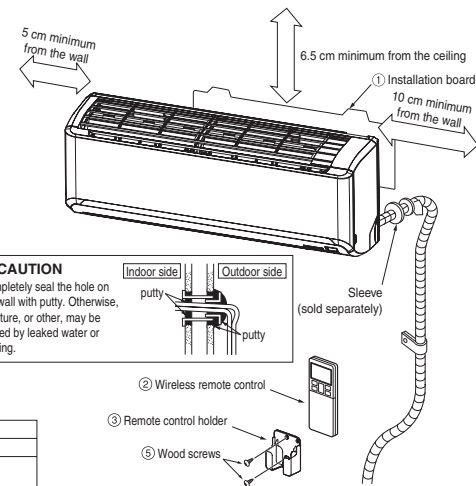
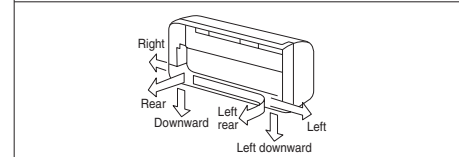

### CAUTION

Completely seal the hole on the wall with putty. Otherwise, furniture, or other, may be wetted by leaked water or dewing.

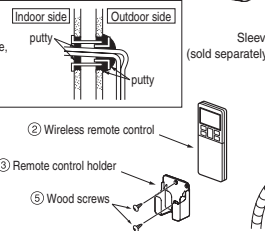

### Relation between setting plate and indoor unit

#### INSTALLATION SPACE (INDOOR UNIT) (FRONT VIEW)

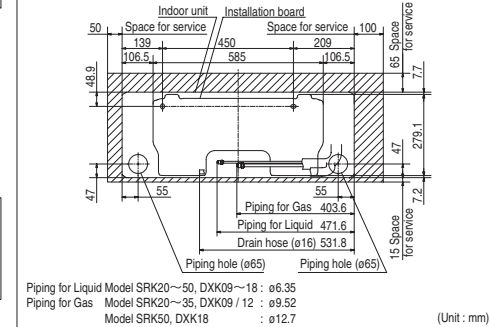

### [Drain hose changing procedures]

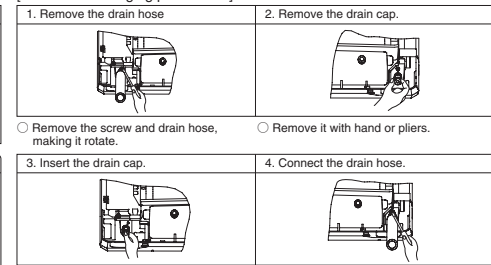

- Remove the screw and drain hose, making it rotate.
- Remove it with hand or pliers.
- Insert the drain cap which was removed at procedure "2" securely using a hexagonal wrench etc. Note: Be careful that if it is not inserted securely, water leakage may occur.
- Insert the drain hose securely, making rotate. And install the screw. Note: Be careful that if it is not inserted securely, water leakage may occur.

### Fixing of indoor unit

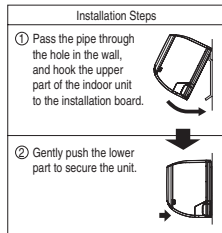
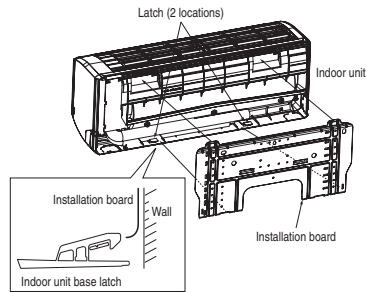

#### • How to remove the indoor unit from the installation board

- Push up at the marked portion of the indoor unit base lower latch, and slightly pull it toward you. (both right and left hand sides) (The indoor unit base lower latch can be removed from the installation board)
- Push up the indoor unit upward. So the indoor unit will be removed from the installation board.

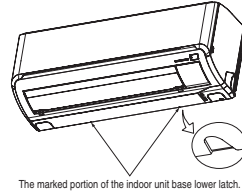

Since this air conditioner has been designed to collect dew drops on the rear surface to the drain pan, do not attach the power cord above the gutter.



### Drainage

- Arrange the drain hose in a downward angle.
  - Avoid the following drain piping.
- CAUTION** Go through all installation steps and check if the drainage is all right. Otherwise water leak may occur.

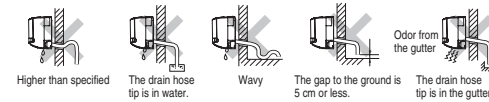

- Pour water to the drain pan located under the heat exchanger, and ensure that the water is discharged outdoor.
- When the extended drain hose is indoor, securely insulate it with a heat insulator available in the market.

## CONNECTION OF REFRIGERANT PIPINGS

**Preparation** Keep the openings of the pipes covered with tapes etc. to prevent dust, sand, etc. from entering them.



- Remove the flared nuts. (on both liquid and gas sides)

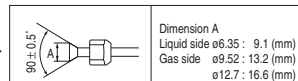

- Install the removed flared nuts to the pipes to be connected, then flared the pipes.

**CAUTION**  
Do not apply refrigerating machine oil to the flared surface.

#### • Flaring work

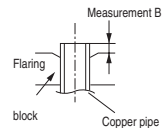

Copper pipe diameter	Measurement B (mm)		
	Clutch type flare tool for R410A	Conventional (R22) flare tool	
		Clutch type	Wing nut type
ø6.35	0.0 - 0.5	1.0 - 1.5	1.5 - 2.0
ø9.52	0.0 - 0.5	1.0 - 1.5	1.5 - 2.0
ø12.7	0.0 - 0.5	1.0 - 1.5	2.0 - 2.5

Use a flare tool designed for R410A or a conventional flare tool.  
Please note that measurement B (protrusion from the flaring block) will vary depending on the type of a flare tool in use.  
If a conventional flare tool is used, please use a copper pipe gauge or a similar instrument to check protrusion so that you can keep measurement B to a correct value.

### Connection

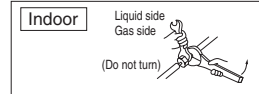

- Connect the pipes on both liquid and gas sides.
- Tighten the nuts to the following torque.  
Liquid side (ø6.35): 14.0 - 18.0 N·m (1.4 - 1.8 kgf·m)  
Gas side (ø9.52): 34.0 - 42.0 N·m (3.4 - 4.2 kgf·m)  
(ø12.7): 49.0 - 61.0 N·m (4.9 - 6.1 kgf·m)

**CAUTION**  
Do not apply excess torque to the flared nuts. Otherwise, the flared nuts may check depending.

### Insulation of the connection portion

Cover the coupling with insulator and then cover it with tapes.

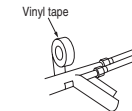

Use an attached insulation pad for heat insulation.

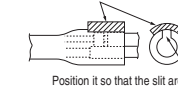

- Cover the indoor unit's flare-connected joints, after they are checked for a gas leak, with an indoor unit heat insulating material and then wrap them with a tape with an attached insulation pad placed over the heat insulating material's slit area.

### Finishing work and fixing

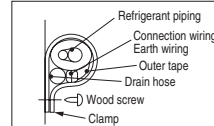

Cover the exterior portion with outer tape and shape the piping so it will match the contours of the route that the piping to take.  
Also fix the wiring and pipings to the wall with clamps.

### Open/close and detachment/attachment of the air inlet panel

- To open, pull the panel at both ends of lower part and release latches, then pull up the panel until you feel resistance.  
(The panel stops at approx. 60° open position)
- To close, hold the panel at both ends of lower part to lower downward and push it slightly until the latch works.
- To remove, pull up the panel to the position shown in right illustration and pull it toward you.
- To install, insert the panel arm into the slot on the front panel from the position shown in right illustration, hold the panel at both ends of lower part, lower it downward slowly, then push it slightly until the latch works.

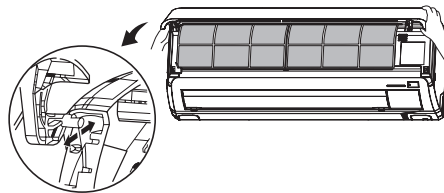

### How to remove and fit the front panel

- Removing
  - Remove the air inlet panel.
  - Remove the 2 set screws.
  - Remove the 3 latches in the upper section.
  - Move the lower part of the panel forward and push upwards to remove.
- Fitting
  - Do remove the air filter.
  - Cover the body with the front panel.
  - Fit the 3 latches in the upper section.
  - Tighten the 2 set screws.
  - Fit the air filter.
  - Fit the air inlet panel.

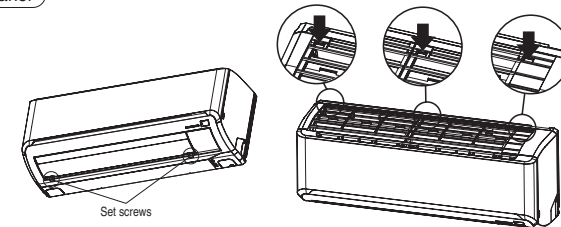

## ELECTRICAL WIRING WORK

### Preparation of indoor unit

#### Mounting of connecting wires

- ① Remove the lid.
- ② Remove the terminal cover.
- ③ Remove the wiring clamp.
- ④ Connect the connecting wire securely to the terminal block.
  - 1) Connect the connection wire securely to the terminal block. If the wire is not affixed completely, contact will be poor, and it is dangerous as the terminal block may heat up and catch fire.
  - 2) Take care not to confuse the terminal numbers for indoor and outdoor connections.
- ⑤ Fix the connecting wire by wiring clamp.
- ⑥ Attach the terminal cover.
- ⑦ Attach the lid.

### CAUTION

In case of faulty wiring connection, the indoor unit stops, and then the run lamp turns on and the timer lamp blinks.

Use cables for interconnection wiring to avoid loosening of the wires. CENELEC code for cables Required field cables.

H05RN4G1.5 (example) or 245IEC57
H Harmonized cable type
05 300/500 volts
R Natural-and/or synth, rubber wire insulation
N Polychloroprene rubber conductors insulation
R Stranded core
4or5 Number of conductors
G One conductor of the cable is the earth conductor (yellow/green)
1.5 Section of copper wire (mm <sup>2</sup> )

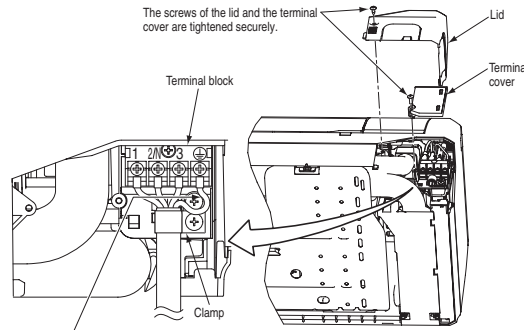

• Earth wire shall be Yellow/Green (Y/G) in color and longer than other AC wires for safety reason.

### Installing the air-cleaning filters

1. Open the air inlet panel and remove the air filters.
2. Install the air-cleaning filter in the filter holders, and then install the filter holders in the air conditioner.
  - Each air-cleaning filter can be installed in the left or right filter holder.
3. Install the air filters and close the inlet panel.

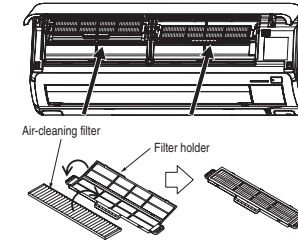

## INSTALLATION OF WIRELESS REMOTE CONTROL

### Mounting method of battery

- Uncover the wireless remote control, and mount the batteries [R03 (AAA, Micro), ×2 pieces] in the body regularly. (Fit the poles with the indication marks, ⊕ & ⊖ without fail)

**CAUTION**  
Do not use new and old batteries together.

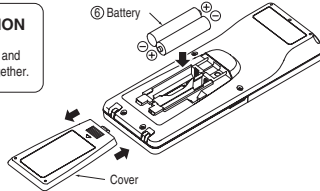

### Fixing to pillar or wall

- Conventionally, operate the wireless remote control by holding in your hand.
- Avoid installing it on a clay wall etc.

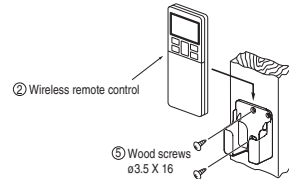

## INSTALLING TWO AIR CONDITIONERS IN THE SAME ROOM

When two air conditioners are installed in the same room, use this setting when the two air conditioners are not operated with one wireless remote control. Set the wireless remote control and indoor unit.

### Setting the wireless remote control

- ① Pull out the cover and take out batteries.
- ② Disconnect the switching line next to the battery with wire cutters.

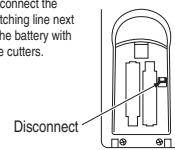

- ③ Insert batteries. Close the cover.

### Setting an indoor unit

- ① Turn off the power supply, and turn it on after 1 minute.
- ② Point the wireless remote control that was set according to the procedure described on the left side at the indoor unit and send a signal by pressing the AC L switch on the wireless remote control. Since the signal is sent in about 6 seconds after the ACL switch is pressed, point the wireless remote control at the indoor unit for some time.
- ③ Check that the reception buzzer sound "pip" is emitted from the indoor unit. At completion of the setting, the indoor unit emits a buzzer sound "pip". (If no reception tone is emitted, start the setting from the beginning again.)

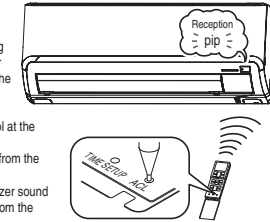

## HOW TO RELOCATE OR DISPOSE OF THE UNIT

- In order to protect the environment, be sure to pump down (recovery of refrigerant).
- Pump down is the method of recovering refrigerant from the indoor unit to the outdoor unit when the pipes are removed from the unit.

- Forced cooling operation  
Turn on a power supply again after a while after turn off a power supply. Then press continually the ON/OFF button 5 seconds or more.

<How to pump down>

- ① Connect charge hose to check joint of outdoor unit.
- ② Liquid side : Close the liquid valve with hexagon wrench key.  
Gas side : Fully open the gas valve.  
Carry out cooling operation. (If indoor temperature is low, operate forced cooling operation.)
- ③ After low pressure gauge become 0.01MPa, stop cooling operation and close the gas valve.

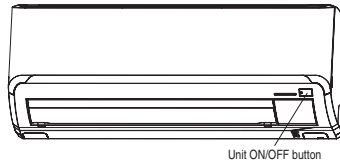

## CONCERNING TERMINAL CONNECTION FOR AN INTERFACE

- ① Remove the front panel and lid of control.
- ② Remove the control.
- ③ There is a terminal (respectively marked with CNS) for the indoor control board. In connecting an interface, connect to the respective terminal securely with the connection harness supplied with an optional "Interface connection kit SC-BIKN-E" and fasten the connection harness onto the indoor control box with the clamp supplied with the kit. For more details, please refer to the user's manual of your "Interface connection kit SC-BIKN-E".

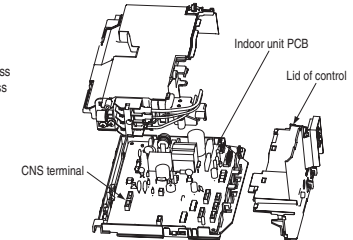

## INSTALLATION TEST CHECK POINTS

Check the following points again after completion of the installation, and before turning on the power. Conduct a test run again and ensure that the unit operates properly. At the same time, explain to the customer how to use the unit and how to take care of the unit following the user's manual.

### After installation

- The power supply voltage is correct as the rating.
- No gas leaks from the joints of the service valve.
- Power cables and crossover wires are securely fixed to the terminal board.
- The screw of the lid and the terminal cover are tightened securely.

- Service valve is fully open.
- The pipe joints for indoor and outdoor pipes have been insulated.

### Test run

- Air conditioning operation is normal.
- No abnormal noise.
- Water drains smoothly.
- Protective functions are not working.

- The wireless remote control is normal.
- Operation of the unit has been explained to the customer. (Three-minutes restart preventive timer)  
When the air conditioner is restarted or when changing the operation, the unit will not start operating for approximately 3 minutes. This is to protect the unit and it is not a malfunction.

(2) Installation of outdoor unit

Models SRC20ZM-S, 25ZM-S, 35ZM-S, 50ZM-S

- This installation manual deals with outdoor units and general installation specifications only. For indoor units, refer to page 25.
- When install the unit, be sure to check whether the selection of installation place, power supply specifications, usage limitation (piping length, height differences between indoor and outdoor units, power supply voltage and etc.) and installation spaces.

**SAFETY PRECAUTIONS**

- Read the "SAFETY PRECAUTIONS" carefully first of all and strictly follow it during the installation work in order to protect yourself.
- The precautionary items mentioned below are distinguished into two levels, **⚠ WARNING** and **⚠ CAUTION**.
  - ⚠ **WARNING** : Wrong installation would cause serious consequences such as injuries or death.
  - ⚠ **CAUTION** : Wrong installation might cause serious consequences depending on circumstances.
 Both mentions the important items to protect your health and safety so strictly follow them by any means.
- Be sure to confirm no anomaly on the equipment by commissioning after completed installation and explain the operating methods as well as the maintenance methods of this equipment to the user according to the owner's manual.
- Keep the installation manual together with owner's manual at a place where any user can read at any time. Moreover if necessary, ask to hand them to a new user.
- For installing qualified personnel, take precautions in respect to themselves by using suitable protective clothing, groves, etc., and then perform the installation works.
- Please pay attention not to fall down the tools, etc. when installing the unit at the high position.
- If unusual noise can be heard during operation, consult the dealer.
- The meanings of "Marks" used here are shown as follows:

	Never do it under any circumstances.			Always do it according to the instruction.
--	--------------------------------------	--	--	--

**⚠ WARNING**

	<ul style="list-style-type: none"> <li>• <b>Installation must be carried out by the qualified installer.</b> If you install the system by yourself, it may cause serious trouble such as water leaks, electric shocks, fire and personal injury, as a result of a system malfunction. Do not carry out the installation and maintenance work except the by qualified installer.</li> <li>• <b>Install the system in full accordance with the installation manual.</b> Incorrect installation may cause bursts, personal injury, water leaks, electric shocks and fire.</li> <li>• <b>Be sure to use only for household and residence.</b> If this appliance is installed in inferior environment such as machine shop and etc., it can cause malfunction.</li> <li>• <b>When installing in small rooms, take prevention measures not to exceed the density limit of refrigerant in the event of leakage, referred by the formula (accordance with ISO5149).</b> If the density of refrigerant exceeds the limit, please consult the dealer and install the ventilation system, otherwise lack of oxygen can occur, which can cause serious accident.</li> <li>• <b>Use the original accessories and the specified components for installation.</b> If parts other than those prescribed by us are used, It may cause water leaks, electric shocks, fire and personal injury.</li> <li>• <b>Install the unit in a location with good support.</b> Unsuitable installation locations can cause the unit to fall and cause material damage and personal injury.</li> <li>• <b>Ensure the unit is stable when installed, so that it can withstand earthquakes and strong winds.</b> Unsuitable installation locations can cause the unit to fall and cause material damage and personal injury.</li> </ul>	<ul style="list-style-type: none"> <li>• <b>Ventilate the working area well in the event of refrigerant leakage during installation.</b> If the refrigerant comes into contact with naked flames, poisonous gas is produced.</li> <li>• <b>Use the prescribed pipes, flare nuts and tools for R410A.</b> Using existing parts (for R22 or R407C) can cause the unit failure and serious accidents due to burst of the refrigerant circuit.</li> <li>• <b>Tighten the flare nut by torque wrench with specified method.</b> If the flare nut were tightened with excess torque, this may cause burst and refrigerant leakage after a long period.</li> <li>• <b>Do not open the service valves for liquid line and gas line until completed refrigerant piping work, air tightness test and evacuation.</b> If the compressor is operated in state of opening service valves before completed connection of refrigerant piping work, air can be sucked into refrigerant circuit, which can cause bust or personal injury due to anomalously high pressure in the refrigerant.</li> <li>• <b>The electrical installation must be carried out by the qualified electrician in accordance with "the norm for electrical work" and "national wiring regulation", and the system must be connected to the dedicated circuit.</b> Power supply with insufficient capacity and incorrect function done by improper work can cause electric shocks and fire.</li> <li>• <b>Be sure to shut off the power before starting electrical work.</b> Failure to shut off the power can cause electric shocks, unit failure or incorrect function of equipment.</li> <li>• <b>Be sure to use the cables conformed to safety standard and cable ampacity for power distribution work.</b> Unconformable cables can cause electric leak, anomalous heat production or fire.</li> <li>• <b>This appliance must be connected to main power supply by means of a</b></li> </ul>	<ul style="list-style-type: none"> <li>• <b>circuit breaker or switch (fuse:16A) with a contact separation of at least 3mm.</b></li> <li>• <b>Arrange the wiring in the control box so that it cannot be pushed up further into the box. Install the service panel correctly.</b> Incorrect installation may result in overheating and fire.</li> <li>• <b>Use the prescribed cables for electrical connection, tighten the cables securely in terminal block and relieve the cables correctly to prevent overloading the terminal blocks.</b> Loose connections or cable mountings can cause anomalous heat production or fire.</li> <li>• <b>Be sure to fix up the service panels.</b> Incorrect fixing can cause electric shocks or fire due to intrusion of dust or water.</li> <li>• <b>Be sure to switch off the power supply in the event of installation, inspection or servicing.</b> If the power supply is not shut off, there is a risk of electric shocks, unit failure or personal injury due to the unexpected start of fan.</li> <li>• <b>Stop the compressor before removing the pipe after shutting the service valve on pump down work.</b> If the pipe is removed when the compressor is in operation with the service valve open, air would be mixed in the refrigeration circuit and it could cause explosion and injuries due to abnormal high pressure in the cooling cycle.</li> <li>• <b>Only use prescribed optional parts. The installation must be carried out by the qualified installer.</b> If you install the system by yourself, it can cause serious trouble such as water leaks, electric shocks, fire.</li> <li>• <b>Be sure to wear protective goggles and gloves while at work.</b></li> <li>• <b>Earth leakage breaker must be installed.</b> If the earth leakage breaker is not installed, it can cause electric shocks.</li> </ul>
	<ul style="list-style-type: none"> <li>• <b>Ensure that no air enters in the refrigerant circuit when the unit is installed and removed.</b> If air enters in the refrigerant circuit, the pressure in the refrigerant circuit becomes too high, which can cause burst and personal injury.</li> <li>• <b>Do not processing, splice the power cord, or share a socket with other power plugs.</b> This may cause fire or electric shock due to defecting contact, defecting insulation and over-current etc.</li> </ul>	<ul style="list-style-type: none"> <li>• <b>Do not bundling, winding or processing for the power cord. Or, do not deforming the power plug due to tread it.</b> This may cause fire or heating.</li> <li>• <b>Do not run the unit with removed panels or protections.</b> Touching rotating equipments, hot surfaces or high voltage parts can cause personal injury due to entrapment, burn or electric shocks.</li> </ul>	<ul style="list-style-type: none"> <li>• <b>Do not perform any change of protective device itself or its setup condition.</b> The forced operation by short-circuiting protective device of pressure switch and temperature controller or the use of non specified component can cause fire or burst.</li> </ul>

## ⚠ CAUTION



• **Carry out the electrical work for ground lead with care.**  
Do not connect the ground lead to the gas line, water line, lightning conductor or telephone line's ground lead. Incorrect grounding can cause unit faults such as electric shocks due to short-circuiting.



• **Use the circuit breaker for all pole correct capacity. Circuit breaker should be the one that disconnect all poles under over current.**  
Using the incorrect circuit breaker, it can cause the unit malfunction and fire.

• **Install isolator or disconnect switch on the power supply wiring in accordance with the local codes and regulations.**  
The isolator should be locked in OFF state in accordance with EN60204-1.

• **After maintenance, all wiring, wiring ties and the like, should be returned to their original state and wiring route, and the necessary clearance from all metal parts should be secured.**

• **Secure a space for installation, inspection and maintenance specified in the manual.**  
Insufficient space can result in accident such as personal injury due to falling from the installation place.

• **Take care when carrying the unit by hand.**  
If the unit weights more than 20kg, it must be carried by two or more persons. Do not carry by the plastic straps, always use the carry handle when carrying the unit by hand. Use gloves to minimize the risk of cuts by the aluminum fins.

• **Dispose of any packing materials correctly.**  
Any remaining packing materials can cause personal injury as it contains nails and wood. And to avoid danger of suffocation, be sure to keep the plastic wrapper away from children and to dispose after tear it up.

• **Be sure to insulate the refrigerant pipes so as not to condense the ambient air moisture on them.**  
Insufficient insulation can cause condensation, which can lead to moisture damage on the ceiling, floor, furniture and any other valuables.

• **When perform the air conditioner operation (cooling or drying operation) in which ventilator is installed in the room. In this case, using the air conditioner in parallel with the ventilator, there is the possibility that drain water may backflow in accordance with the room lapse into the negative pressure status. Therefore, set up the opening port such as incorporate the air into the room that may appropriate to ventilation (For example; Open the door a little). In addition, just as above, so set up the opening port if the room lapse into negative pressure status due to register of the wind for the high rise apartment etc.**



• **Do not install the unit in the locations listed below.**

- Locations where carbon fiber, metal powder or any powder is floating.
- Locations where any substances that can affect the unit such as sulphide gas, chloride gas, acid and alkaline can occur.
- Vehicles and ships.
- Locations where cosmetic or special sprays are often used.
- Locations with direct exposure of oil mist and steam such as kitchen and machine plant.
- Locations where any machines which generate high frequency harmonics are used.
- Locations with salty atmospheres such as coastlines.
- Locations with heavy snow (If installed, be sure to provide base flame and snow hood mentioned in the manual).
- Locations where the unit is exposed to chimney smoke.
- Locations at high altitude (more than 1000m high).
- Locations with ammoniac atmospheres.
- Locations where heat radiation from other heat source can affect the unit.
- Locations without good air circulation.
- Locations with any obstacles which can prevent inlet and outlet air of the unit.
- Locations where short circuit of air can occur (in case of multiple units installation).
- Locations where strong air blows against the air outlet of outdoor unit.
- Locations where something located above the unit could fall.

It can cause remarkable decrease in performance, corrosion and damage of components, malfunction and fire.

• **Do not install the outdoor unit in the locations listed below.**

- Locations where discharged hot air or operating sound of the outdoor unit can bother neighborhood.
- Locations where outlet air of the outdoor unit blows directly to an animal or plants. The outlet air can affect adversely to the plant etc.
- Locations where vibration can be amplified and transmitted due to insufficient strength of structure.
- Locations where vibration and operation sound generated by the outdoor unit can affect seriously (on the wall or at the place near bed room).
- Locations where an equipment affected by high harmonics is placed (TV set or radio receiver is placed within 1m).
- Locations where drainage cannot run off safely.
- It can affect surrounding environment and cause a claim.

• **Do not install the unit near the location where leakage of combustible gases can occur.**  
If leaked gases accumulate around the unit, it can cause fire.

• **Do not install the unit where corrosive gas (such as sulfurous acid gas etc.) or combustible gas (such as thinner and petroleum gases) can accumulate or collect, or where volatile combustible substances are handled.**  
Corrosive gas can cause corrosion of heat exchanger, breakage of plastic parts and etc. And combustible gas can cause fire.

• **Do not install nor use the system close to the equipment that generates electromagnetic fields or high frequency harmonics.**  
Equipment such as inverters, standby generators, medical high frequency equipments and telecommunication equipments can affect the system, and cause malfunctions and breakdowns. The system can also affect medical equipment and telecommunication equipment, and obstruct its function or cause jamming.

• **Do not install the outdoor unit in a location where insects and small animals can inhabit.**  
Insects and small animals can enter the electric parts and cause damage or fire. Instruct the user to keep the surroundings clean.

• **Do not use the base flame for outdoor unit which is corroded or damaged due to long periods of operation.**  
Using an old and damage base flame can cause the unit falling down and cause personal injury.

• **Do not use any materials other than a fuse with the correct rating in the location where fuses are to be used.**  
Connecting the circuit with copper wire or other metal thread can cause unit failure and fire.

• **Do not touch any buttons with wet hands.**  
It can cause electric shocks.

• **Do not touch any refrigerant pipes with your hands when the system is in operation.**  
During operation the refrigerant pipes become extremely hot or extremely cold depending the operating condition, and it can cause burn injury or frost injury.

• **Do not touch the suction or aluminum fin on the outdoor unit.**  
This may cause injury.

• **Do not put anything on the outdoor unit and operating unit.**  
This may cause damage the objects or injury due to falling to the object.

• **Do not use the unit for special purposes such as storing foods, cooling precision instruments and preservation of animals, plants or art.**

• **Do not clean up the unit with water.**

### Check before installation work

- Model name and power source
- Refrigerant piping length
- Piping, wiring and miscellaneous small parts
- Indoor unit installation manual

Accessories for outdoor unit		Q'ty
① (Heat pump type only)	Model SRC20~35	1
	Model DXC09,12	1
	Model SRC50/DXC18	4

Option parts		Q'ty
② Drain elbow (Heat pump type only)		1
④ Sealing plate		1
⑤ Sleeve		1
⑥ Inclination plate		1
⑦ Putty		1
⑧ Drain hose (extension hose)		1
⑨ Piping cover (for insulation of connection piping)		1

Necessary tools for the installation work	
9 Wrench key (Hexagon) [4m/m]	
10 Vacuum pump	
11 Vacuum pump adapter (Anti-reverse flow type) (Designed specifically for R410A)	
12 Gauge manifold (Designed specifically for R410A)	
13 Charge hose (Designed specifically for R410A)	
14 Flaring tool set (Designed specifically for R410A)	
15 Gas leak detector (Designed specifically for R410A)	
16 Gauge for projection adjustment (Used when flare is made by using conventional flare tool)	
1 Plus headed driver	
2 Knife	
3 Saw	
4 Tape measure	
5 Hammer	
6 Spanner wrench	
7 Torque wrench [14.0~62.0N·m (1.4~6.2kgf·m)]	
8 Hole core drill (65mm in diameter)	

### Notabilia as a unit designed for R410A

- Do not use any refrigerant other than R410A. R410A will rise to pressure about 1.6 times higher than that of a conventional refrigerant. A cylinder containing R410A has a pink indication mark on the top.
- A unit designed for R410A has adopted a different size indoor unit service valve charge port and a different size check joint provided in the unit to prevent the charging of a wrong refrigerant by mistake. The processed dimension of the flared part of a refrigerant pipe and a flare nut's parallel side measurement have also been altered to raise strength against pressure. Accordingly, you are required to arrange dedicated R410A tools listed in the table on the left before installing or servicing this unit.
- Do not use a charge cylinder. The use of a charge cylinder will cause the refrigerant composition to change, which results in performance degradation.
- In charging refrigerant, always take it out from a cylinder in the liquid phase.
- All indoor units must be models designed exclusively for R410A. Check connectable indoor unit models in a catalog, etc. (A wrong indoor unit, if connected into the system, will impair proper system operation)



# 1. HAULAGE AND INSTALLATION (Take particular care in carrying in or moving the unit, and always perform such an operation with two or more persons.)

**CAUTION** When a unit is hoisted with slings for haulage, take into consideration the offset of its gravity center position. If not properly balanced, the unit can be thrown off-balance and fall.

## 1) Delivery

- Deliver the unit as close as possible to the installation site before removing it from the packaging.
- When you have to unpack the unit for a compelling reason before you haul it to the installation point, hoist the unit with nylon slings or ropes and protection pads so that you may not damage the unit.

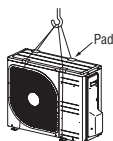

## 2) Portage

- The right hand side of the unit as viewed from the front (diffuser side) is heavier. A person carrying the right hand side must take heed of this fact. A person carrying the left hand side must hold with his right hand the handle provided on the front panel of the unit and with his left hand the corner column section.

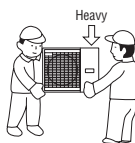

## 3) Selecting the installation location

Be careful of the following conditions and choose an installation place.

- Where air is not trapped.
- Where the installation fittings can be firmly installed.
- Where wind does not hinder the intake and outlet pipes.
- Out of the heat range of other heat sources.
- A place where stringent regulation of electric noises is applicable.
- Where it is safe for the drain water to be discharged.
- Where noise and hot air will not bother neighboring residents.
- Where snow will not accumulate.
- Where strong winds will not blow against the outlet pipe.
- A place where no TV set or radio receiver is placed within 1m.  
(If electrical interference is caused, seek a place less likely to cause the problem)
- If a operation is conducted when the outdoor air temperature is  $-5^{\circ}\text{C}$  lower, the outdoor unit should be installed at a place where it is not influenced by natural wind.
- Where it is likely that the unit is subjected to strong winds, provide wind guards according to the following guidelines. Strong winds can cause performance degradation, an accidental stop due to a rise of high pressure and a broken fan.

- (2) If the unit can be affected by strong wind, following measures are required.  
Strong wind can cause damage of fan (fan motor), or can cause performance degradation, or can trigger anomalous stop of the unit due to rising of high pressure.

1 Place the unit outlet side is turned to the wall.

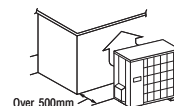

2 Install so the direction of the air from the blowing outlet will be perpendicular to the direction of the wind.

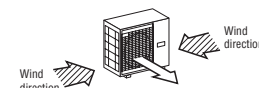

## 5) Installation space

- Walls surrounding the unit in the four sides are not acceptable.
- There must be a 1-meter or larger space in the above.
- When more than one unit are installed side by side, provide a 250mm or wider interval between them as a service space. In order to facilitate servicing of controllers, please provide a sufficient space between units so that their top plates can be removed easily.
- Where a danger of short-circuiting exists, install guide louvers.
- When more than one unit are installed, provide sufficient intake space consciously so that short-circuiting may not occur.
- Where piling snow can bury the outdoor unit, provide proper snow guards.

Example installation Size	Model SRC20~50/DXC09~18 (mm)			
	I	II	III	IV
L1	Open	280	280	180
L2	100	75	Open	Open
L3	100	80	80	80
L4	250	Open	250	Open

The height of a wall is 1200mm or less.

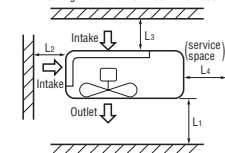

## 4) Caution about selection of installation location

(1) If the unit is installed in the area where the snow will accumulate, following measures are required.  
The bottom plate of unit and intake, outlet may be blocked by snow.

- 1 Install the unit on the base so that the bottom is higher than snow cover surface.      2 Install the unit under or provide the roof on site.

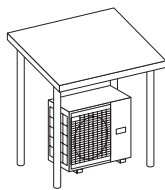
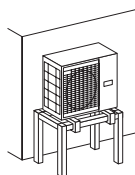

- Since drain water generated by defrost control may freeze, following measures are required.
- Do not execute drain piping work by using a drain elbow and drain grommets (accessories).  
[Refer to Drain piping work.]

## 6) Installation

① Anchor bolt fixed position

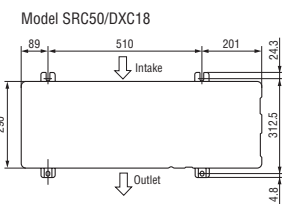
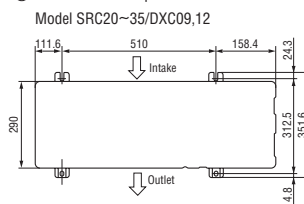

② Notabilia for installation

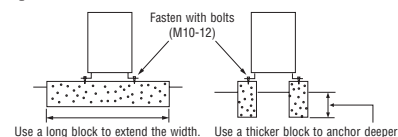

- In installing the unit, fix the unit's legs with bolts specified on the above.
- The protrusion of an anchor bolt on the front side must be kept within 15mm.
- Securely install the unit so that it does not fall over during earthquakes or strong winds, etc.
- Refer to the above illustrations for information regarding concrete foundations.
- Install the unit in a level area. (With a gradient of 5mm or less.) Improper installation can result in a compressor failure, broken piping within the unit and abnormal noise generation.

## 2. REFRIGERANT PIPING WORK

### 1) Restrictions on unit installation and use

- Check the following points in light of the indoor unit specifications and the installation site.
- Observe the following restrictions on unit installation and use. Improper installation can result in a compressor failure or performance degradation.
- Additional refrigerant charge is not required at all (Model SRC20~35/DXC09,12).

Restrictions		Dimensional restrictions		Marks appearing in the drawing on the right
		Model SRC20~35/DXC09,12	Model SRC50/DXC18	
Main pipe length		15m or less	25m or less	L
Elevation difference between indoor and outdoor units	When the outdoor unit is positioned higher,	10m or less	15m or less	H
	When the outdoor unit is positioned lower,	10m or less	15m or less	H

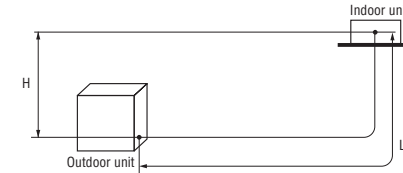

**CAUTION** The use restrictions appearing in the table above are applicable to the standard pipe size combinations shown in the table below.

### 2) Determination of pipe size

Determine refrigerant pipe size pursuant to the following guidelines based on the indoor unit specifications.

	Model SRC20~35/DXC09,12		Model SRC50/DXC18	
	Gas pipe	Liquid pipe	Gas pipe	Liquid pipe
Outdoor unit connected	ø9.52 Flare	ø6.35 Flare	ø12.7 Flare	ø6.35 Flare
Refrigerant piping (branch pipe L)	ø9.52	ø6.35	ø12.7	ø6.35
Indoor unit connected	ø9.52	ø6.35	ø12.7	ø6.35

#### When pipe is brazing.

##### About brazing

**Brazing must be performed under a nitrogen gas flow.** Without nitrogen gas, a large quantity of foreign matters (oxidized film) are created, causing a critical failure from capillary tube or expansion valve clogging.

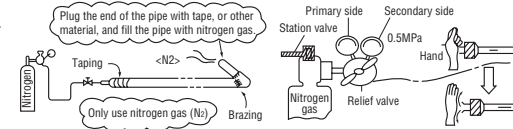

Pipe diameter [mm]	ø6.35	ø9.52	ø12.7
Minimum pipe wall thickness [mm]	0.8	0.8	0.8
Pipe material*	O-type pipe	O-type pipe	O-type pipe

\*Phosphorus deoxidized seamless copper pipe ICS 23.040.15, ICS 77.150.30

### 3) Refrigerant pipe wall thickness and material

- Select refrigerant pipes of the table shown on the right wall thickness and material as specified for each pipe size.

**NOTE** Select pipes having a wall thickness larger than the specified minimum pipe thickness.

### 4) On-site piping work

**IMPORTANT** Take care so that installed pipes may not touch components within a unit. If touching with an internal component, it will generate abnormal sounds and/or vibrations.

#### How to remove the side cover

Please remove the screw of a side cover and remove to the front.

- Carry out the on site piping work with the service valve fully closed.
- Give sufficient protection to a pipe end (compressed and blazed, or with an adhesive tape) so that water or foreign matters may not enter the piping.
- Bend a pipe to a radius as large as practical (R100~R150). Do not bend a pipe repeatedly to correct its form.
- Flare connection is used between the unit and refrigerant pipe. Flare a pipe after engaging a flare nut onto it. Flare dimensions for R410A are different from those for conventional R407C. Although we recommend the use of flaring tools designed specifically for R410A, conventional flaring tools can also be used by adjusting the measurement of protrusion B with a protrusion control gauge.
- The pipe should be anchored every 1.5m or less to isolate the vibration.
- Tighten a flare joint securely.

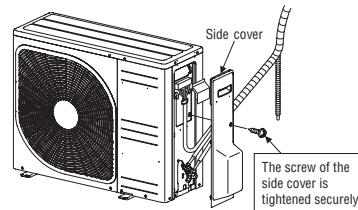

Flared pipe end : A (mm)	
Copper pipe outer diameter	A -04
ø6.35	9.1
ø9.52	13.2
ø12.7	16.6

Copper pipe protrusion for flaring : B (mm)		
Copper pipe outer diameter	In the case of a rigid (clutch) type	
	With an R410A tool	With a conventional tool
ø6.35	0~0.5	1.0~1.5
ø9.52		
ø12.7		

**CAUTION** Do not apply force beyond proper fastening torque in tightening the flare nut.

Fix both liquid and gas service valves at the valve main bodies as illustrated on the right, and then fasten them, applying appropriate fastening torque.

Service valve size (mm)	Tightening torque (N·m)	Tightening angle (°)	Recommended length of a tool handle (mm)
ø6.35 (1/4")	14~18	45~60	150
ø9.52 (3/8")	34~42	30~45	200
ø12.7 (1/2")	49~61	30~45	250

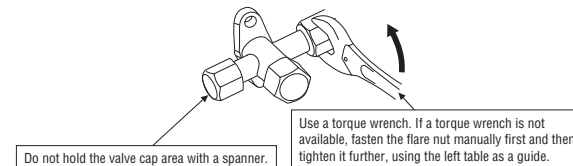

### 5) Air tightness test

- ① Although outdoor and indoor units themselves have been tested for air tightness at the factory, check the connecting pipes after the installation work for air tightness from the service valve's check joint equipped on the outdoor unit side. While conducting a test, keep the service valve shut all the time.
  - a) Raise the pressure to 0.5MPa, and then stop. Leave it for five minutes to see if the pressure drops.
  - b) Then raise the pressure to 1.5MPa, and stop. Leave it for five more minutes to see if the pressure drops.
  - c) Then raise the pressure to the specified level (4.15MPa), and record the ambient temperature and the pressure.
  - d) If no pressure drop is observed with an installation pressurized to the specified level and left for about one day, it is acceptable. When the ambient temperature fall 1°C, the pressure also fall approximately 0.01MPa. The pressure, if changed, should be compensated for.
  - e) If a pressure drop is observed in checking e) and a) – d), a leak exists somewhere. Find a leak by applying bubble test liquid to welded parts and flare joints and repair it. After repair, conduct an air tightness test again.
- ② In conducting an air tightness test, use nitrogen gas and pressurize the system with nitrogen gas from the gas side. Do not use a medium other than nitrogen gas under any circumstances.

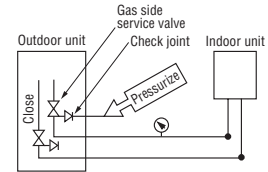

### 6) Evacuation

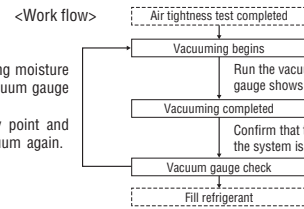

When the system has remaining moisture inside or a leaky point, the vacuum gauge indicator will rise. Check the system for a leaky point and then draw air to create a vacuum again.

#### Pay attention to the following points in addition to the above for the R410A and compatible machines.

- To prevent a different oil from entering, assign dedicated tools, etc. to each refrigerant type. Under no circumstances must a gauge manifold and a charge hose in particular be shared with other refrigerant types (R22, R407C, etc.).
- Use a counterflow prevention adapter to prevent vacuum pump oil from entering the refrigerant system.

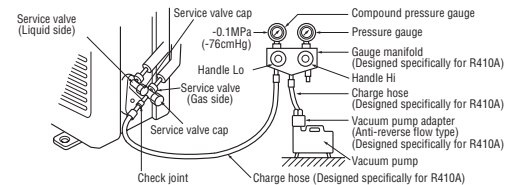

Securely tighten the service valve cap and the check joint blind nut after adjustment.

Service valve size (mm)	Service valve cap tightening torque (N·m)	Check joint blind nut tightening torque (N·m)
ø6.35 (1/4")	20 ~ 30	10 ~ 12
ø9.52 (3/8")		
ø12.7 (1/2")	25 ~ 35	

### 7) Additional refrigerant charge (Model SRC50/DXC18)

- (1) Calculate a required refrigerant charge volume from the following table.

	Additional charge volume (kg) per meter of refrigerant piping (liquid pipe ø6.35)	Refrigerant volume charged for shipment at the factory (kg)	Installation's pipe length (m) covered without additional refrigerant charge
Model SRC50/DXC18	0.02	1.35	15

- This unit contains factory charged refrigerant covering 15m of refrigerant piping and additional refrigerant charge on the installation site is not required for an installation with up to 15m refrigerant piping. When refrigerant piping exceeds 15m, additionally charge an amount calculated from the pipe length and the above table for the portion in excess of 15m.

Formula to calculate the volume of additional refrigerant required

$$\text{Additional charge volume (kg)} = \{ \text{Main length (m)} - \text{Factory charged volume 15 (m)} \} \times 0.02 \text{ (kg/m)}$$

- \* When an additional charge volume calculation result is negative, it is not necessary to charge refrigerant additionally.
- For an installation measuring 15m or shorter in pipe length, please charge the refrigerant volume charged for shipment at the factory, when you recharge refrigerant after servicing etc.

### 8) Heating and condensation prevention

- (1) Dress refrigerant pipes (both gas and liquid pipes) for heat insulation and prevention of dew condensation.
  - Improper heat insulation/anti-dew dressing can result in a water leak or dripping causing damage to household effects, etc.
- (2) Use a heat insulating material that can withstand 120°C or a higher temperature. Poor heat insulating capacity can cause heat insulation problems or cable deterioration.
  - All gas pipes must be securely heat insulated in order to prevent damage from dripping water that comes from the condensation formed on them during a cooling operation or personal injury from burns because their surface can reach quite a high temperature due to discharged gas flowing inside during a heating operation.
  - Wrap indoor units' flare joints with heat insulating parts (pipe cover) for heat insulation (both gas and liquid pipes).
  - Give heat insulation to both gas and liquid side pipes. Bundle a heat insulating material and a pipe tightly together so that no gaps may be left between them and wrap them together with a connecting cable by a dressing tape.
  - **Both gas and liquid pipes need to be dressed with 20mm or thicker heat insulation materials above the ceiling where relative humidity exceeds 70%.**

- (2) Charging refrigerant

- Since R410A refrigerant must be charged in the liquid phase, you should charge it, keeping the container cylinder upside down or using a refrigerant cylinder equipped with a siphon tube.
- Charge refrigerant always from the liquid side service port with the service valve shut. When you find it difficult to charge a required amount, fully open the outdoor unit valves on both liquid and gas sides and charge refrigerant from the gas (suction) side service port, while running the unit in the cooling mode. In doing so, care must be taken so that refrigerant may be discharged from the cylinder in the liquid phase all the time. When the cylinder valve is throttled down or a dedicated conversion tool to change liquid phase refrigerant into mist is used to protect the compressor, however, adjust charge conditions so that refrigerant will gasify upon entering the unit.
- In charging refrigerant, always charge a calculated volume by using a scale to measure the charge volume.
- When refrigerant is charged with the unit being run, complete a charge operation within 30minutes. Running the unit with an insufficient quantity of refrigerant for a long time can cause a compressor failure.

**NOTE** Put down the refrigerant volume calculated from the pipe length onto the caution label attached on the service panel.

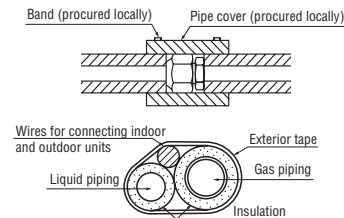



### 3. DRAIN PIPING WORK

- Execute drain piping by using a drain elbow and drain grommets supplied separately as accessories, where water drained from the outdoor unit is a problem.
- Water may drip where there is a larger amount of drain water. Seal around the drain elbow and drain grommets with putty or adequate caulking material.
- Condensed water may flow out from vicinity of service valve or connected pipes.
- Where you are likely to have several days of sub-zero temperatures in a row, do not use a drain elbow and drain grommets. (There is a risk of drain water freezing inside and blocking the drain.)

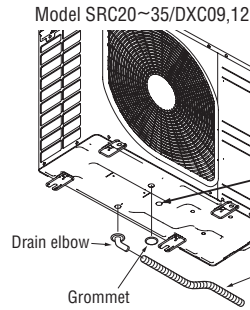

#### CAUTION

Do not put a grommet on this hole. This is a supplementary drain hole to discharge drain water, when a large quantity of it is gathered.

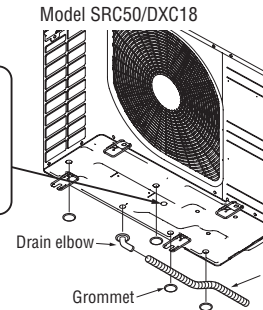

- When condensed water needs to be led to a drain, etc., install the unit on a flat base (supplied separately as an optional part) or concrete blocks. Then, please secure space for the drain elbow and the drain hose.

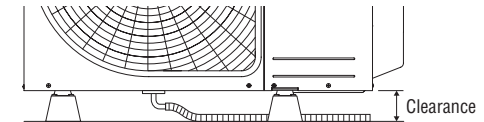

### 4. ELECTRICAL WIRING WORK For details of electrical cabling, refer to the indoor unit installation manual.

Electrical installation work must be performed by an electrical installation service provider qualified by a power provider of the country. Electrical installation work must be executed according to the technical standards and other regulations applicable to electrical installations in the country.

- Do not use any supply cord lighter than one specified in parentheses for each type below.
  - braided cord (code designation 60245 IEC 51)
  - ordinary tough rubber sheathed cord (code designation 60245 IEC 53)
  - flat twin tinsel cord (code designation 60227 IEC 41)
- Use polychloroprene sheathed flexible cord (code designation 60245 IEC57) for supply cords of parts of appliances for outdoor use.
- Ground the unit. Do not connect the grounding wire to a gas pipe, water pipe, lightning rod or telephone grounding wire. If improperly grounded, an electric shock or malfunction may result.
- A grounding wire must be connected before connecting the power cable. Provide a grounding wire longer than the power cable.
- The installation of an impulse withstanding type earth leakage breaker is necessary. A failure to install an earth leakage breaker can result in an accident such as an electric shock or a fire.
- Do not turn on the power until the electrical work is completed.
- Do not use a condensive capacitor for power factor improvement under any circumstances. (It does not improve power factor, while it can cause an abnormal overheat accident)
- For power supply cables, use conduits.
- Do not lay electronic control cables (wireless remote control and signaling wires) and other cables together outside the unit. Laying them together can result in the malfunctioning or a failure of the unit due to electric noises.
- Fasten cables so that may not touch the piping, etc.
- When cables are connected, make sure that all electrical components within the electrical component box are free of loose connector coupling or terminal connection and then attach the cover securely. (Improper cover attachment can result in malfunctioning or a failure of the unit, if water penetrates into the box.)
- Never use a shield cable.
- SRC-ZMA-S, SRC-ZMXA-S and DXC-ZMA-S complies with the DRED (Demand Response Enabling Devices) standard AS/NZS4755.3.1 and supports demand response modes 1, 2, and 3 (DRM1, 2, and 3). Since the air conditioner limits the electric power or energy by receiving the DRED input signal, the sense of cooling operation or heating operation may deteriorate over time. The outdoor unit of this air conditioner is equipped with a terminal block for DRED input and supports ELV (Extra-Low Voltage) complying with AS/NZS60335.1.

#### CAUTION

In case of faulty wiring connection, the indoor unit stops, and then the run lamp turns on and the timer lamp blinks.

Use cables for interconnection wiring to avoid loosening of the wires. CENELEC code for cables Required field cables.

H05RNR4G1.5 (Example) or 245IEC57	
H	Harmonized cable type
05	300/500 volts
R	Natural-and/or synth. rubber wire insulation
N	Polychloroprene rubber conductors insulation
R	Stranded core
4or5	Number of conductors
G	One conductor of the cable is the earth conductor (yellow/green)
1.5	Section of copper wire (mm <sup>2</sup> )

**Power cable, indoor - outdoor connecting wire circuit diagram**

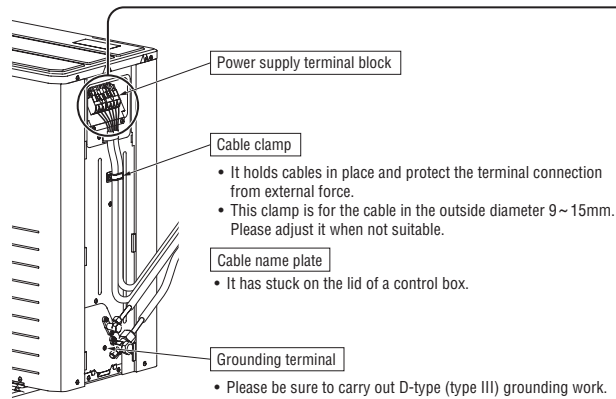

**Model SRC20~35ZM-S  
Model SRC20~35ZMX-S**

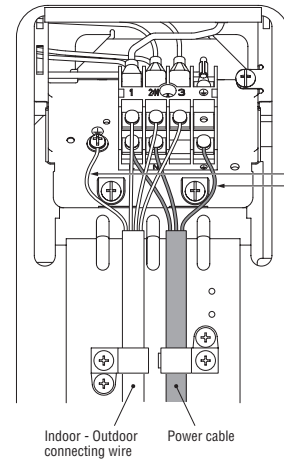

**Model SRC20~35ZMA-S  
Model SRC20~35ZMXA-S  
Model DXC09, 12ZMA-S**

• Earth wire shall be Yellow/Green (Y/G) in color and longer than other AC wires for safety reason.

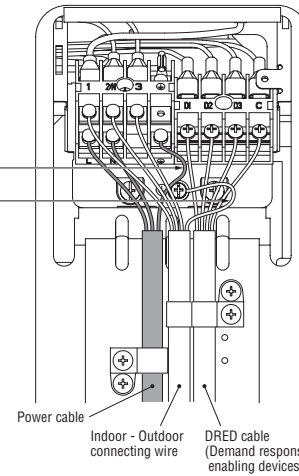

**Power cable, indoor-outdoor connecting wires**

**Model SRC-ZM-S  
Model SRC-ZMX-S**

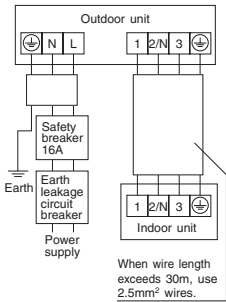

**Model SRC-ZMA-S  
Model SRC-ZMXA-S**

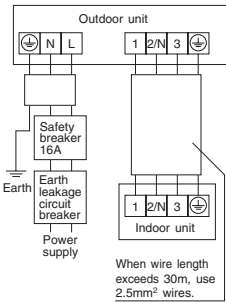

**Model DXC-ZMA-S**

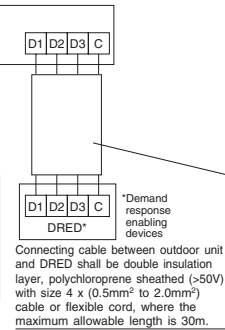

- Always perform grounding system installation work with the power cord unplugged.
- Connect a pair bearing a common terminal number with an indoor-outdoor connecting wire.
- In cabling, fasten cables securely with cable clamps so that no external force may work on terminal connections.
- Grounding terminals are provided in the control box.

**CAUTION** Always use an earth leakage circuit breaker designed for inverter circuits to prevent a faulty operation.

Phase	Earth leakage breaker	Switchgear or Circuit Breaker		Power source (minimum)	Interconnecting and grounding wires (minimum)
		Switch breaker	Over current protector rated capacity		
Single-phase	15A, 30mA, 0.1sec or less	30A	16A	2.0mm <sup>2</sup>	1.5mm <sup>2</sup> X 4

- The specifications shown in the above table are for units without heaters. For units with heaters, refer to the installation instructions or the construction instructions of the indoor unit.
- Switchgear or Circuit breaker capacity which is calculated from MAX. over current should be chosen along the regulations in each country.
- The cable specifications are based on the assumption that a metal or plastic conduit is used with no more than three cables contained in a conduit and a voltage drop is 2%. For an installation falling outside of these conditions, please follow the internal cabling regulations. Adapt it to the regulation in effect in each country.

**Model SRC50ZM-S**

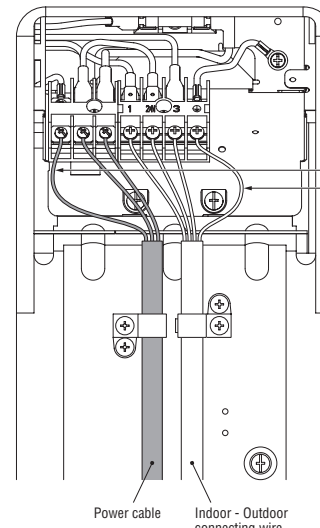

**Model SRC50ZMA-S  
Model DXC18ZMA-S**

• Earth wire shall be Yellow/Green (Y/G) in color and longer than other AC wires for safety reason.

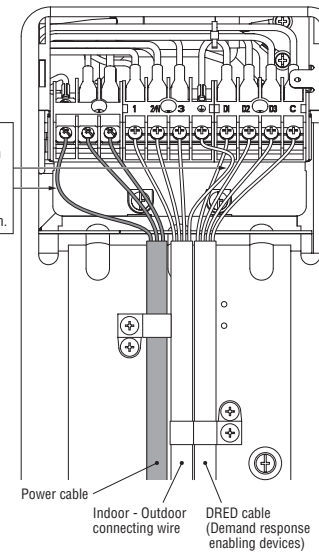

## 5. UTILIZATION OF EXISTING PIPING

Check whether an existing pipe system is reusable or not by using the following flow chart.

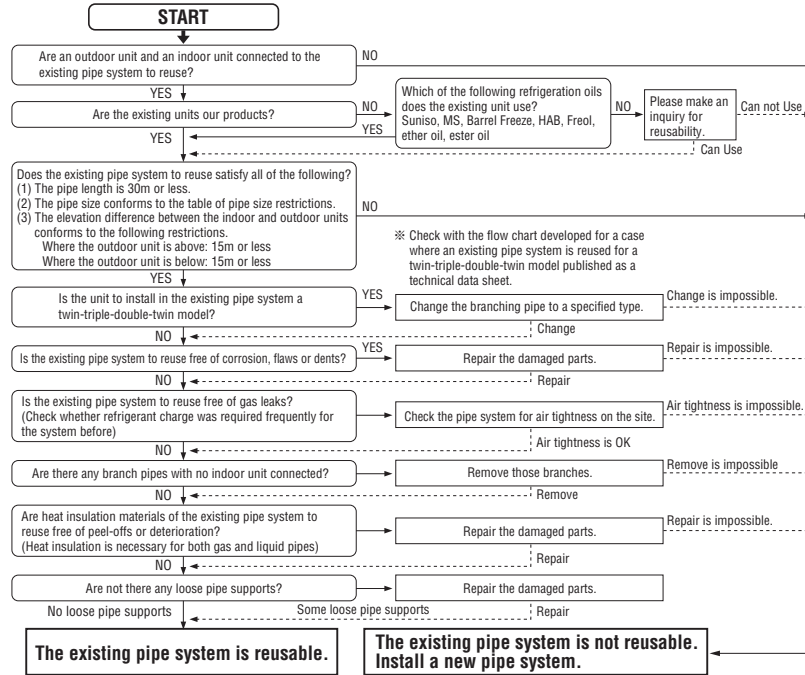

<Table of pipe size restrictions>

◎: Standard pipe size

Additional charge volume per meter of pipe		0.02kg/m
Pipe size	Liquid pipe	ø6.35
	Gas pipe	ø9.52
	Usability	◎
20-35	Maximum one-way pipe length	15
	Length covered without additional charge	10

- Please consult with our distributor in the area, if you need to recover refrigerant and charge it again.
- Any combinations of pipe sizes not listed in the table are not usable.



**WARNING**

<Where the existing unit can be run for a cooling operation.>

Carry out the following steps with the existing unit (in the order of (1), (2), (3) and (4))

- (1) Run the unit for 30 minutes for a cooling operation.
- (2) Stop the indoor fan and run the unit for 3 minutes for a cooling operation (returning liquid)
- (3) Close the liquid side service valve of the outdoor unit and pump down (refrigerant recovery)
- (4) Blow with nitrogen gas. ※ If discolored refrigeration oil or any foreign matters is discharged by the blow, wash the pipe system or install a new pipe system.
  - For the flare nut, do not use the old one, but use the one supplied with the outdoor unit. Process a flare to the dimensions specified for R410A.

<Where the existing unit cannot be run for a cooling operation.>

Wash the pipe system or install a new pipe system.

- If you choose to wash the pipe system, please contact our distributor in the area.

## INSTALLATION TEST CHECK POINTS

Check the following points again after completion of the installation, and before turning on the power. Conduct a test run again and ensure that the unit operates properly. Explain to the customer how to use the unit and how to take care of the unit following the instruction manual.

### After installation

- |  |   |
|--|---|
| <input type="checkbox"/> Power cables and connecting wires are securely fixed to the terminal block. | <input type="checkbox"/> The pipe joints for indoor and outdoor pipes have been insulated.                      |
| <input type="checkbox"/> The power supply voltage is correct as the rating.                          | <input type="checkbox"/> The reverse flow check cap is attached.  |
| <input type="checkbox"/> The drain hose is fixed securely.   | <input type="checkbox"/> The cover of the pipe cover (A) faces downward to prevent rain from entering.          |
| <input type="checkbox"/> Service valve is fully open.  | <input type="checkbox"/> Gaps are properly sealed between the pipe covers (A) (B) and the wall surface / pipes. |
| <input type="checkbox"/> No gas leaks from the joints of the service valve.                          | <input type="checkbox"/> The screw of the side cover is tightened securely.                                     |

# 9. OUTLINE OF OPERATION CONTROL BY MICROCOMPUTER

## (1) Operation control function by wireless remote control

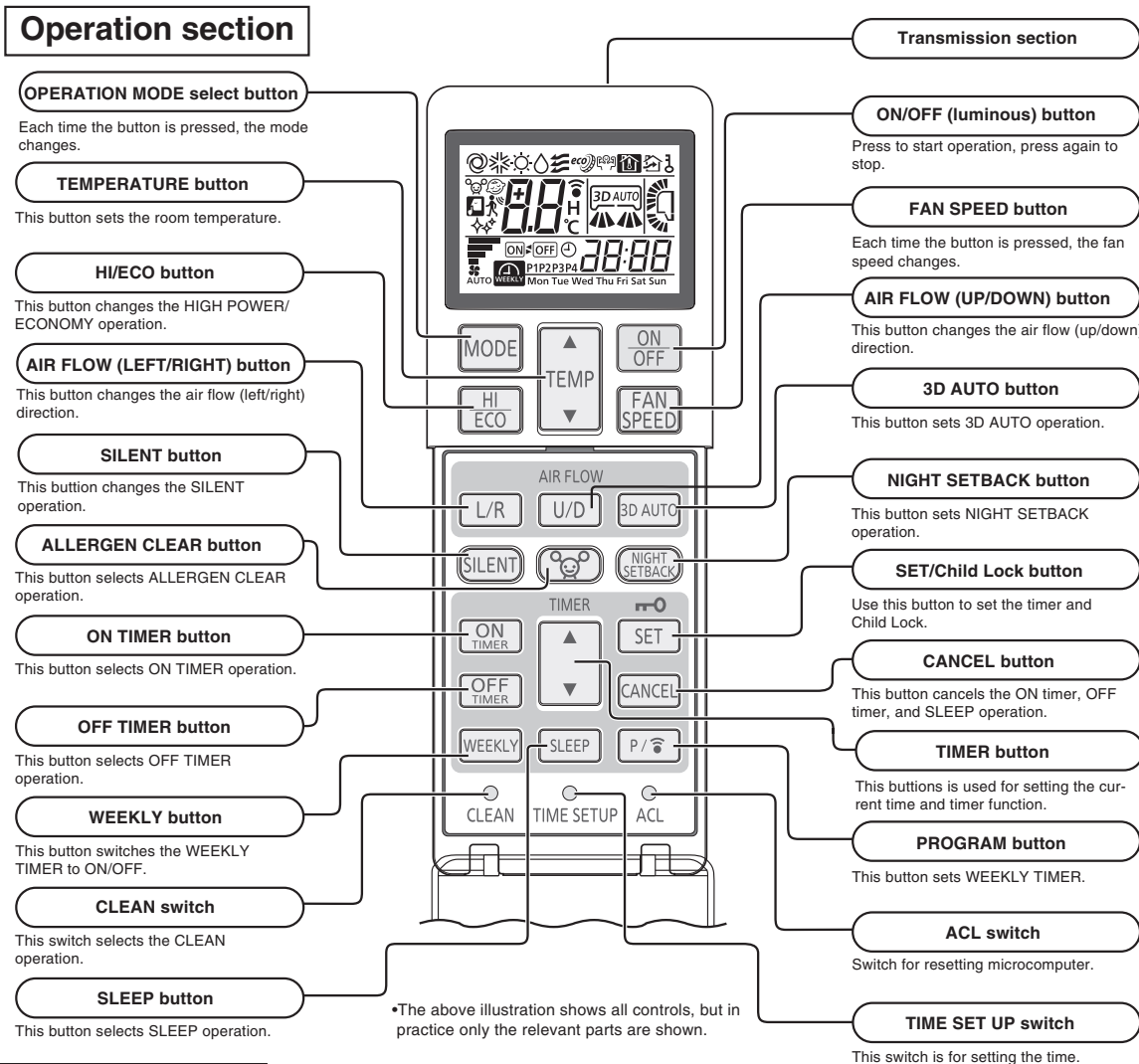

## Unit display section

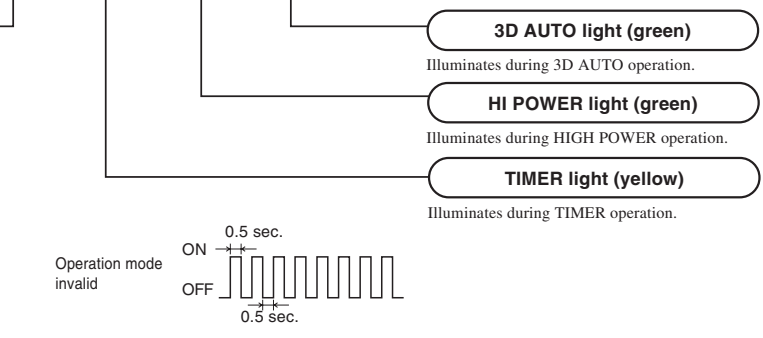
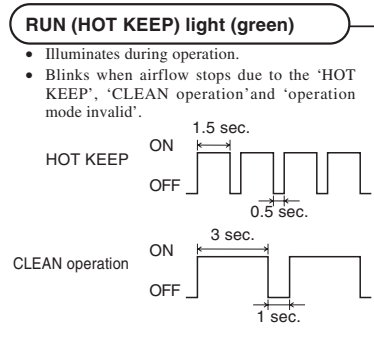
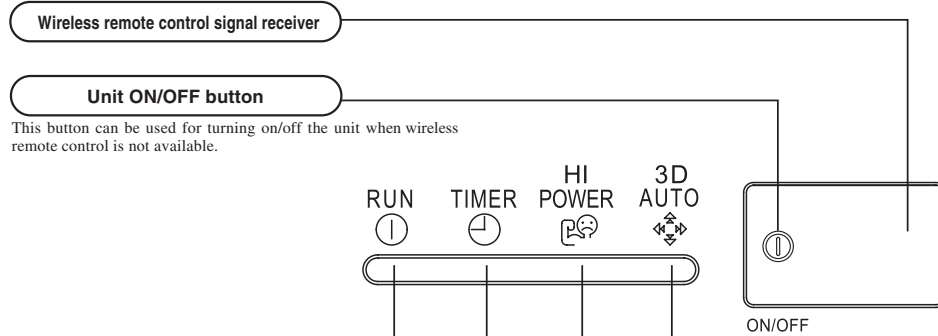

**(2) Unit ON/OFF button**

When the wireless remote control batteries become weak, or if the wireless remote control is lost or malfunctioning, this button may be used to turn the unit on and off.

**(a) Operation**

Push the button once to place the unit in the automatic mode. Push it once more to turn the unit off.

**(b) Details of operation**

The unit will go into the automatic mode in which it automatically determines, from indoor temperature (as detected by sensor), whether to go into the cooling, thermal dry or heating modes.

Function	Indoor temperature setting	Fan speed	Flap/Louver	Timer Switch
Operation mode				
COOL	About 24°C	Auto	Auto	Continuous
DRY	About 25°C			
HEAT	About 26°C			

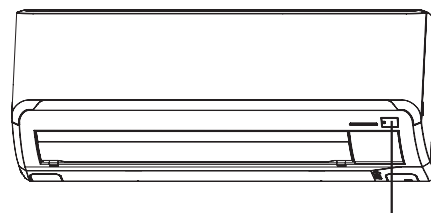

Unit ON/OFF button

**(3) Auto restart function**

**(a)** Auto restart function records the operational status of the air-conditioner immediately prior to be switched off by a power cut, and then automatically resumes operations after the power has been restored.

**(b)** The following settings will be cancelled:

- (i) Timer settings
- (ii) HIGH POWER operation

- Notes
- (1) Auto restart function is set at on when the air-conditioner is shipped from the factory. Consult with your dealer if this function needs to be switched off.
  - (2) When power failure occurs, the timer setting is cancelled. Once power is resumed, reset the timer.
  - (3) If the jumper wire (JA1) "AUTO RESTART" is cut, auto restart is disabled. (See the diagram at right)

Jumper wire (JA1)

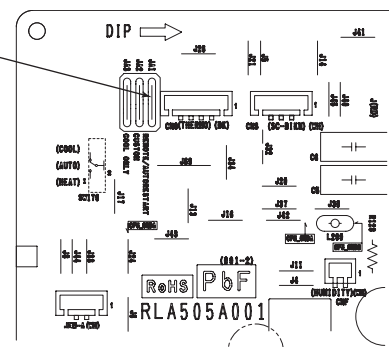

**(4) Installing two air conditioners in the same room**

When two air conditioners are installed in the room, use setting when the two air conditioners are not operated with one wireless remote control. Set the wireless remote control and indoor unit.

**(a) Setting the wireless remote control**

- (i) Pull out the cover and take out batteries.
- (ii) Disconnect the switching line next to the battery with wire cutters.
- (iii) Insert batteries. Close the cover.

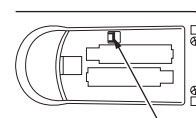

Disconnect

**(b) Setting an indoor unit**

- (i) Turn off the power supply, and turn it on after 1 minute.
- (ii) Point the wireless remote control that was set according to the procedure described on the left side at the indoor unit and send a signal by pressing the ACL switch on the wireless remote control.  
Since the signal is sent in about 6 seconds after the ACL switch is pressed, point the wireless remote control at the indoor unit for some time.
- (iii) Check that the reception buzzer sound "pip" is emitted from the indoor unit.  
At completion of the setting, the indoor unit emits a buzzer sound "pip".  
(If no reception tone is emitted, start the setting from the beginning again.)

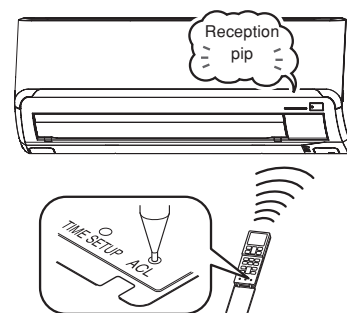

**(5) Selection of the annual cooling function**

**(a) The annual cooling function can be enabled or disabled by means of the jumper wire (JA3) on the indoor unit PCB and the dip switch (SW2-4) on the interface kit (option) PCB.**

Jumper wire (JA3)	Interface kit (SC-BIKN-E) SW2-4	Function
Shorted	ON	Enabled
Shorted	OFF	Disabled
Open	ON	Disabled
Open	OFF	Disabled

Note: (1) Default states of the jumper wire (JA3) and the interface kit at the shipping from factory – On the PCB, the dip switch (SW2-4) is set to enable the annual cooling function.

(2) To cancel the annual cooling setting, consult your dealer.

**(b) Content of control**

(i) If the outdoor air temperature sensor (TH2) detects below 5°C, the indoor unit speed is switched to 7th step.

(ii) If the outdoor air temperature sensor (TH2) detects higher than 10°C, the indoor unit speed is changed to the normal control speed.

**(6) High power operation**

Pressing the HI POWER/ECONO button intensifies the operating power and initiates powerful cooling and heating operation for 15 minutes continuously. The remote control displays and the FAN SPEED display disappears.

**(a)** During the HIGH POWER operation, the room temperature is not controlled. When it causes an excessive cooling and heating, press the HI POWER/ECONO button again to cancel the HIGH POWER operation.

**(b)** HIGH POWER operation is not available during the DRY and the program timer operations.

**(c)** When HIGH POWER operation is set after ON TIMER operation, HIGH POWER operation will start from the set time.

**(d)** When the following operation are set, HIGH POWER operation will be canceled.

- ① When the HI POWER/ECONO button is pressed again.
- ② When the operation mode is changed.
- ③ When it has been 15 minutes since HIGH POWER operation has started.
- ④ When the 3D AUTO button is pressed.
- ⑤ When the SILENT button is pressed.
- ⑥ When the NIGHT SETBACK button is pressed.

**(e)** Not operable while the air conditioner is OFF.

**(f)** After HIGH POWER operation, the sound of refrigerant flowing may be heard.

**(7) Economy operation**

Pressing the HI POWER/ECONO button initiate a soft operation with the power suppressed in order to avoid an excessive cooling or heating. The unit operate 1.5°C higher than the setting temperature during cooling or 2.5°C lower than that during heating. The remote control displays ECONO mark and the FAN SPEED display disappears.

**(a)** It will go into ECONOMY operation at the next time the air conditioner runs in the following cases.

- ① When the air-conditioner is stopped by ON/OFF button during ECONOMY operation.
- ② When the air-conditioner is stopped in SLEEP or OFF TIMER operation during ECONOMY operation.
- ③ When the operation is retrieved from CLEAN or ALLERGEN CLEAR operation.

**(b)** When the following operation are set, ECONOMY operation will be canceled.

- ① When the HI POWER/ECONO button is pressed again.
- ② When the operation mode is changed DRY to FAN.
- ③ When the NIGHT SETBACK button is pressed.

**(c)** Not operable while the air-conditioner is OFF.

**(d)** The setting temperature is adjusted according to the following table.

Mode	Cooling	Heating
Temperature adjustment	① +0.5	① -1.0
	② +1.0	② -2.0
	③ +1.5	③ -2.5

- ① at the start of operation.
- ② one hour after the start of operation.
- ③ two hours after the start of operation.

Jumper wire (JA3)

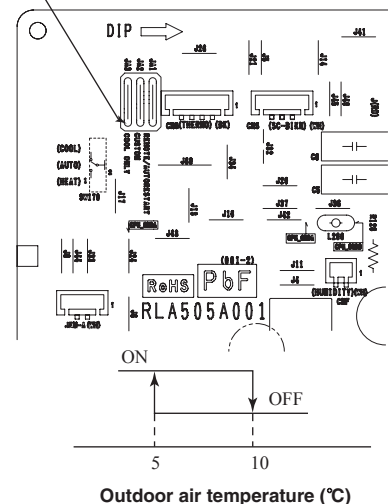

**(8) Flap and louver control**

Control the flap and louver by AIR FLOW  $\blacklozenge$  (UP/DOWN) and  $\blacktriangleleft\blacktriangleright$  (LEFT/RIGHT) button on the wireless remote control.

**(a) Flap**

Each time when you press the AIR FLOW  $\blacklozenge$  (UP/DOWN) button the mode changes as follows.

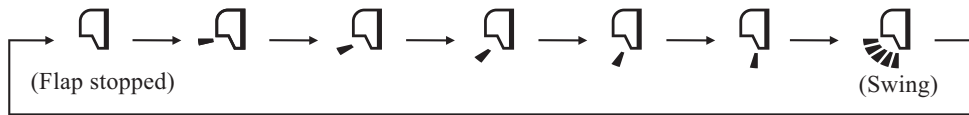

• Angle of Flap from Horizontal

Remote control display					
<b>COOL , DRY, FAN</b>	Approx. 10°	Approx. 25°	Approx. 40°	Approx. 50°	Approx. 60°
<b>HEAT</b>	Approx. 25°	Approx. 40°	Approx. 50°	Approx. 60°	Approx. 70°

**(b) Louver**

Each time when you press the AIR FLOW  $\blacktriangleleft\blacktriangleright$  (LEFT/RIGHT) button the mode changes as follows.

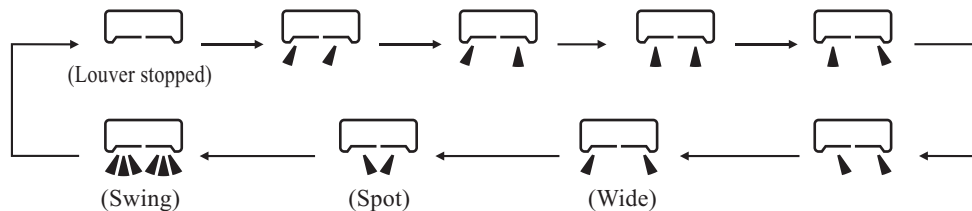

• Angle of Louver

Remote control display					
<b>Center installation</b>	Left Approx. 50°	Left Approx. 20°	Center	Right Approx. 20°	Right Approx. 50°
<b>Right end installation</b>	Left Approx. 50°	Left Approx. 45°	Left Approx. 30°	Center	Right Approx. 20°
<b>Left end installation</b>	Left Approx. 20°	Center	Right Approx. 30°	Right Approx. 45°	Right Approx. 50°

**(c) Swing**

(i) Swing flap

Flap moves in upward and downward directions continuously.

$\blacklozenge$  In HEAT operation       $\blacklozenge$  In COOL, DRY, FAN operation

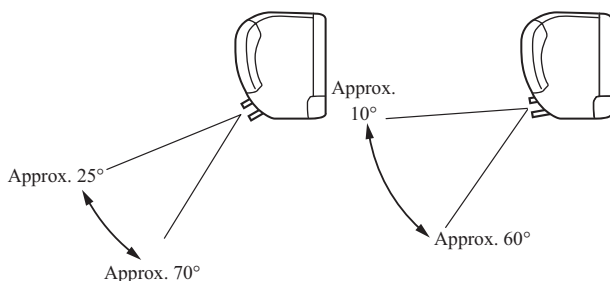

(ii) Swing louver

Louver moves in left and right directions continuously.



**(d) Memory flap (Flap or Louver stopped)**

When you press the AIR FLOW (UP/DOWN or LEFT/RIGHT) button once while the flap or louver is operating, it stops swinging at the position. Since this angle is memorized in the microcomputer, the flap or louver will automatically be set at this angle when the next operation is started.

**(e) When not operating**

The flap returns to the position of air flow directly below, when operation has stopped.



**(9) 3D auto operation**

Control the flap and louver by 3D AUTO button on the wireless remote control.

Air flow selection and air flow direction are automatically controlled, allowing the entire indoor to efficiently conditioned.

**(a) During Cooling and Heating (Including auto cooling and heating)**

(i) Air flow selection is determined according to indoor temperature and setting temperature.

Operation mode	Air flow selection				
	AUTO		HI	MED	LO
Cooling	Indoor temp. – Setting temp. >5°C	Indoor temp. – Setting temp. ≤ 5°C	HI	MED	LO
	HIGH POWER	AUTO			
Heating	Setting temp. – Indoor temp. >5°C	Setting temp. – Indoor temp. ≤ 5°C	HI	MED	LO
	HIGH POWER	AUTO			

(ii) Air flow direction is controlled according to the indoor temperature and setting temperature.

1) When 3D auto operation starts

	Cooling	Heating
Flap	Up/down Swing	
Louver	Wide (Fixed)	Center (Fixed)

2) When Indoor temp. – Setting temp. is ≤ 5°C during cooling and when Setting temp. – Indoor temp. is ≤ 5°C during heating, the system switches to the following air flow direction control. After the louver swings left and right symmetrically for 3 cycles, control is switched to the control in 3).

	Cooling	Heating
Flap	Horizontal blowing (Fixed)	Slant forwardl blowing (Fixed)
Louver	Left/right Swing	

3) After the flap swings for 5 cycles, control is switched to the control in 4).

	Cooling	Heating
Flap	Up/down Swing	
Louver	Center (Fixed)	

4) For 5 minutes, the following air flow direction control is carried out.

	Cooling	Heating
Flap	Horizontal blowing (Fixed)	Slant forwardl blowing (Fixed)
Louver	Wide (Fixed)	

5) After 5 minutes have passed, the air flow direction is determined according to the indoor temperature and setting temperature.

Operation mode	Air flow direction control		
Cooling	Indoor temp. – Setting temp. ≤ 2°C	2°C < Indoor temp. – Setting temp. ≤ 5°C	Indoor temp. – Setting temp. > 5°C
	The control in 4) continues.	Control returns to the control in 2).	Control returns to the control in 1).
Heating	Setting temp. – Indoor temp. ≤ 2°C	2°C < Setting temp. – Indoor temp. ≤ 5°C	Setting temp. – Indoor temp. > 5°C
	The control in 4) continues.	Control returns to the control in 2).	Control returns to the control in 1).

**(b) During DRY Operation (including auto DRY operation)**

Flap	Horizontal blowing (Fixed)
Louver	Wide (Fixed)



**(10) Timer operation**

**(a) Comfortable timer setting (ON timer)**

If the timer is set at ON when the operation select switch is set at the cooling or heating, or the cooling or heating in auto mode operation is selected, the comfortable timer starts and determines the starting time of next operation based on the initial value of 15 minutes and the relationship between the indoor temperature at the setting time (temperature of room temperature sensor) and the setting temperature.

**(b) Sleep timer operation**

Pressing the SLEEP button causes the temperature to be controlled with respect to the set temperature.

**(c) OFF timer operation**

The Off timer can be set at a specific time (in 10-minute units) within a 24-hour period.

**(d) Weekly timer operation**

Timer operation (ON timer, OFF timer) can be set up to 4 times a day for each weekday.

**(11) Silent mode**

As “Silent mode start” signal is received from the wireless remote control, it operates by dropping the outdoor fan tap and the compressor command speed.

	SRK20ZM-S		SRK25ZM-S		SRK35ZM-S		SRK50ZM-S	
	Cooling	Heating	Cooling	Heating	Cooling	Heating	Cooling	Heating
<b>Outdoor fan tap (Upper limit)</b>	4th speed	4th speed	4th speed	4th speed	5th speed	4th speed	4th speed	4th speed
<b>Compressor command speed (Upper limit)</b>	30 rps	46 rps	37 rps	49 rps	50 rps	56 rps	46 rps	46 rps

**(12) Night setback**

As “Night setback” signal is received from the wireless remote control, the heating operation starts with the setting temperature at 10°C.

**(13) Installation location setting**

When the indoor unit is installed at the end of a room, control the air flow direction so that it is not toward the side walls. If you set the wireless remote control installation position, keep it so that the air flow is within the range shown in the following figure.

**(a) Setting**

**(i) If the air conditioning unit is running, press the ON/OFF button to stop.**

The installation location setting cannot be made while the unit is running.

**(ii) Press the AIR FLOW U/D (UP/DOWN) button and the AIR FLOW L/R (LEFT/RIGHT) button together for 5 seconds or more.**

The installation location display illuminates.

**(iii) Setting the air-conditioning installation location.**

Press the AIR FLOW L/R (LEFT/RIGHT) button and adjust to the desired location.

Each time the AIR FLOW L/R (LEFT/RIGHT) button is pressed, the indicator is switched in the order of:

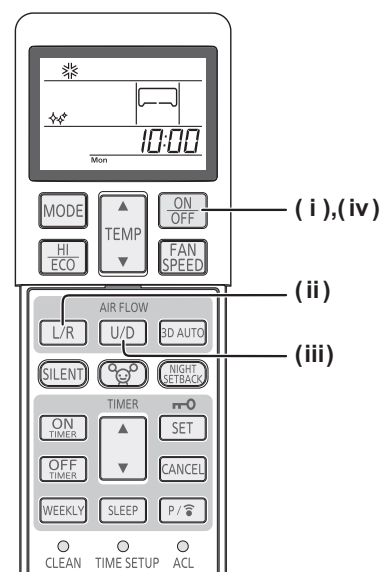

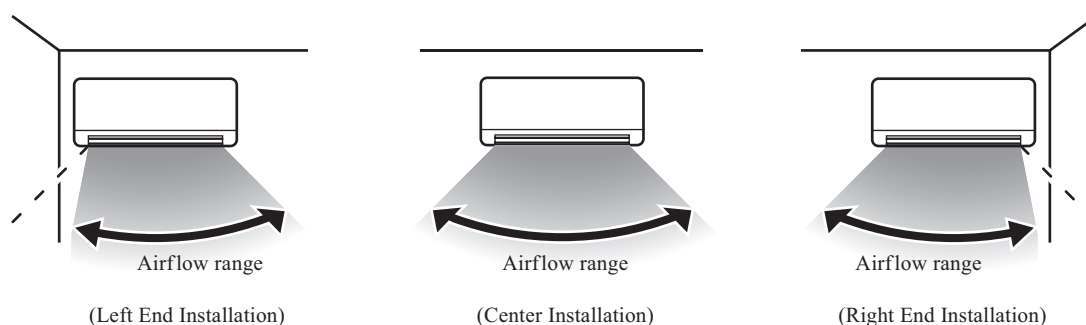

**(iv) Press the ON/OFF button.**

The air-conditioner's installation location is set.

Press within 60 seconds of setting the installation location (while the installation location setting display illuminates).

**(14) Outline of heating operation**

**(a) Operation of major functional components in heating mode**

	Heating		
	Thermostat ON	Thermostat OFF	Failure
Compressor	ON	OFF	OFF
Indoor fan motor	ON	ON(HOT KEEP)	OFF
Outdoor fan motor	ON	OFF (few minutes ON)	OFF
4-way valve	ON	ON	OFF (3 minutes ON)

**(b) Details of control at each operation mode (pattern)**

**(i) Fuzzy operation**

Deviation between the indoor temperature setting correction temperature and the return air temperature is calculated in accordance with the fuzzy rule, and used for control of the air capacity and the compressor speed.

Model	SRK20ZM-S	SRK25ZM-S	SRK35ZM-S	SRK50ZM-S
<b>Fan speed</b>				
Auto	30~115rps	30~115rps	30~115rps	23~106rps
HI	30~115rps	30~115rps	30~115rps	23~106rps
MED	30~66rps	30~72rps	30~76rps	23~78rps
LO	30~40rps	30~42rps	30~46rps	23~50rps
ULO	30~40rps	30~40rps	30~40rps	23~37rps

When the defrosting, protection device, etc. is actuated, operation is performed in the corresponding mode.

**(ii) Hot keep operation**

If the hot keep operation is selected during the heating operation, the indoor blower is controlled based on the temperature of the indoor heat exchanger (Th2) to prevent blowing of cool wind.

However, if the fan speed setting is HI and room temperature is 19°C or higher, this control is not executed.

**(c) Defrosting operation**

**(i)** Starting conditions (Defrosting operation can be started only when all of the following conditions are met.)

- 1) After start of heating operation  
When it elapsed 45 (model SRK50 : 35) minutes. (Accumulated compressor operation time)
- 2) After end of defrosting operation  
When it elapsed 45 (model SRK50 : 35) minutes. (Accumulated compressor operation time)
- 3) Outdoor heat exchanger sensor (TH1) temperature  
When the temperature has been below -5°C for 3 minutes continuously.

- 4) The difference between the outdoor air sensor temperature and the outdoor heat exchanger sensor temperature
- The outdoor air temperature  $\geq 0^{\circ}\text{C}$  (model 50 :  $\geq -2^{\circ}\text{C}$ ) :  $7^{\circ}\text{C}$  or higher
  - $-15^{\circ}\text{C} \leq$  The outdoor air temperature  $< 0^{\circ}\text{C}$  (model SRK50 :  $\geq -2^{\circ}\text{C}$ ) :  $4/15 \times$  The outdoor air temperature +  $7^{\circ}\text{C}$  or higher
  - The outdoor air temperature  $< -15^{\circ}\text{C}$  :  $-5^{\circ}\text{C}$  or higher

Models SRK20~35

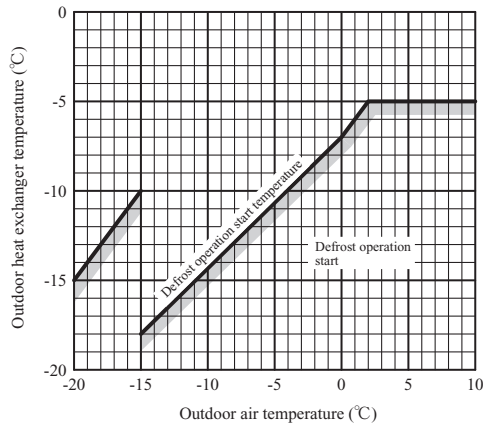

Model SRK50

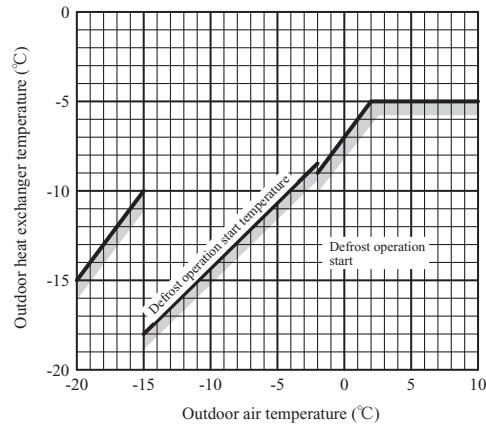

- 5) During continuous compressor operation
- In addition, when the speed command from the indoor controller of the indoor unit during heating operation has counted 0 rps 10 times or more and all conditions of 1), 2), 3) and 5) above and the outdoor air temperature is  $3^{\circ}\text{C}$  or less are satisfied (note that when the temperature for outdoor heat exchanger sensor (TH1) is  $-5^{\circ}\text{C}$  or less: 62 rps or more,  $-4^{\circ}\text{C}$  or less: less than 62 rps), defrost operation is started.
- (ii) Ending conditions (Operation returns to the heating cycle when either one of the following is met.)
- 1) Outdoor heat exchanger sensor (TH1) temperature:  $13^{\circ}\text{C}$  (model SRK50 :  $10^{\circ}\text{C}$ ) or higher
  - 2) Continued operation time of defrosting  $\rightarrow$  For more than 16 minutes and 50 seconds (model SRK50 : 18 minutes).

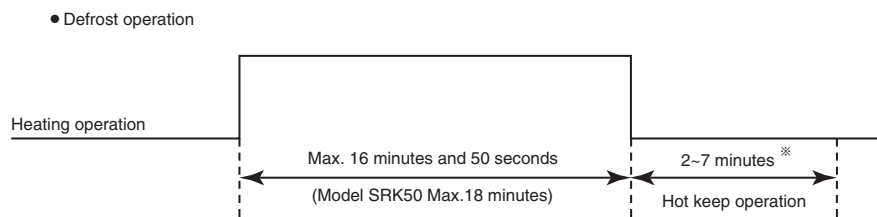

\*Depends on an operation condition, the time can be longer than 7 minutes.

(15) Outline of cooling operation

(a) Operation of major functional components in cooling mode

	Cooling		
	Thermostat ON	Thermostat OFF	Failure
Compressor	ON	OFF	OFF
Indoor fan motor	ON	ON	OFF
Outdoor fan motor	ON	OFF (few minutes ON)	OFF (few minutes ON)
4-way valve	OFF	OFF	OFF

**(b) Detail of control in each mode (Pattern)**

**(i) Fuzzy operation**

During the fuzzy operation, the air flow and the compressor speed are controlled by calculating the difference between the indoor temperature setting correction temperature and the return air temperature.

Fan speed \ Model	SRK20ZM-S	SRK25ZM-S	SRK35ZM-S	SRK50ZM-S
Auto	20~66rps	20~74rps	20~98rps	23~96rps
HI	20~66rps	20~74rps	20~98rps	23~96rps
MED	20~44rps	20~55rps	20~58rps	23~62rps
LO	20~34rps	20~38rps	20~42rps	23~46rps
ULO	20~30rps	20~34rps	20~38rps	23~37rps

**(16) Outline of dry(dehumidifying) operation**

**(a) Purpose of DRY mode**

The purpose is "Dehumidification", and not to control the humidity to the target condition. Indoor/outdoor unit control the operation condition to reduce the humidity, and also prevent over cooling.

**(b) Outline of control**

(i) Indoor unit fan speed and compressor are controlled by the area which is selected by the temperature difference.

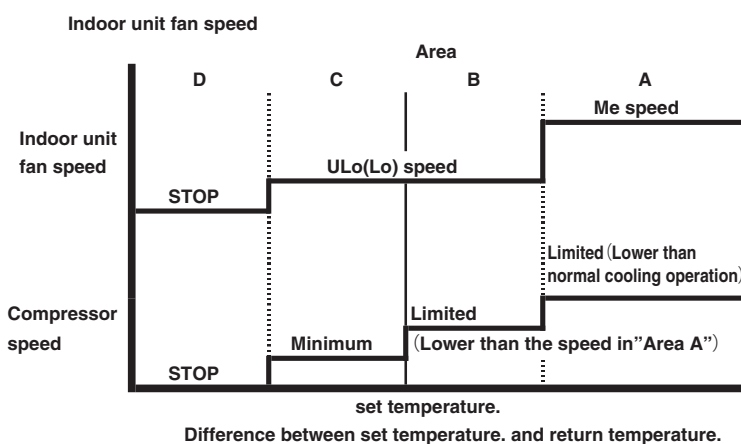

(ii) The indoor unit check the current area by every 5 minutes, and operate by the next checking.

**(c) Other**

When the outside temperature. and room temperature. is low for cooling operation, indoor unit can not operate in cooling, and dehumidify. In this case, the units operate in heating to rise the room temperature and after that start DRY operation.

**(17) Outline of automatic operation**

**(a) Determination of operation mode**

The unit checks the indoor air temperature and setting temperature and the outdoor air temperature, determines the operation mode, and then begins in the automatic operation.

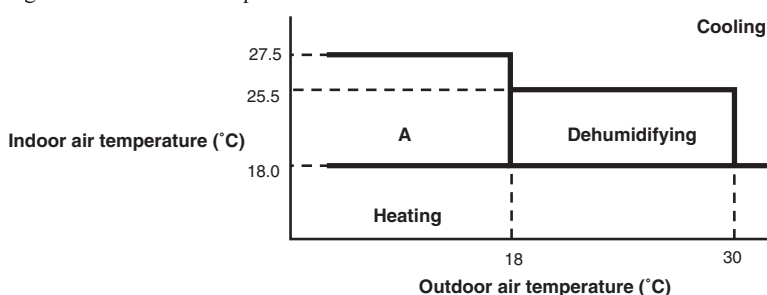

- (b) The unit checks the temperature every hour after the start of operation and, if the result of check is not same as the previous operation mode, changes the operation mode.
  - (i) If the setting temperature is changed with the remote control, the operation mode is judged immediately.
  - (ii) When both the indoor and the outdoor air temperatures are in the range “A”, cooling or heating is switched depending on the difference between the setting temperature and the indoor air temperature.
  - (iii) When the operation mode has been judged following the change of setting temperature with the remote control, the hourly judgment of operation mode is cancelled.
- (c) When the unit is started again within one hour after the stop of automatic operation or when the automatic operation is selected during heating, cooling or dehumidifying operation, the unit is operated in the previous operation mode.
- (d) Setting temperature can be adjusted within the following range. There is the relationship as shown below between the signals of the wireless remote control and the setting temperature.

Unit : °C

		Signals of wireless remote control (Display)												
		-6	-5	-4	-3	-2	-1	±0	+1	+2	+3	+4	+5	+6
Setting temperature	Cooling	18	19	20	21	22	23	24	25	26	27	28	29	30
	Dehumidifying	19	20	21	22	23	24	25	26	27	28	29	30	31
	Heating	20	21	22	23	24	25	26	27	28	29	30	31	32

- (e) When the unit is operated automatically with the wired remote control connected, the cooling operation is controlled according to the display temperatures while the setting temperature is compensated by +1°C during dehumidifying or by +2°C during heating.

**(18) Protective control function**

**(a) Dew prevention control II [Cooling]: Prevents dewing on the indoor unit. (SRK35, 50ZM-S only)**

- (i) **Operating conditions:** When the following conditions have been met for more than 30 minutes after starting operation
  - 1) Compressor's command speed is 32 (model SRK50:28) rps or higher.
  - 2) Detected value of humidity is 68% or higher.
- (ii) **Contents of operation**
  - 1) Air capacity control

		Model	SRK35ZM-S	SRK50ZM-S
LO	Upper limit of compressor's command speed		RangeA: 45rps, RangeB: 45rps	RangeA: 50rps, RangeB: 40rps
	Indoor fan		4th speed	
AUTO,HI,MED	Upper limit of compressor's command speed		RangeA: 45rps, RangeB: 45rps	RangeA: 50rps, RangeB: 40rps
	Indoor fan		Adaptable to compressor's command speed (Lower limit 4th speed)	

Note (1) Ranges A and B are as shown below.

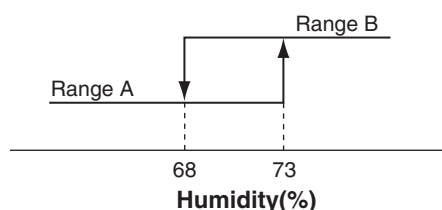

- 2) When this control has continued for more than 30 minutes continuously, the following wind direction control is performed.
  - a) When the vertical wind direction is set at other than the vertical swing, the flaps change to the horizontal position.
  - b) When the horizontal wind direction is set at other than the horizontal swing, the louver changes to the vertical position.
- (iii) **Resetting condition:** When any of followings is met.
  - 1) Compressor's command speed is less than 32 (model SRK50:28) rps.
  - 2) Detected value of humidity is less than 63%.

**(b) Frost prevention control** (During cooling or dehumidifying)

**(i) Operating conditions**

- 1) Indoor heat exchanger temperature (Th2) is lower than 5°C.
- 2) 5 minutes after reaching the compressor command speed except 0 rps.

**(ii) Detail of anti-frost operation**

Indoor heat exchanger temperature	5°C or lower	2.5°C or lower
Item		
Lower limit of compressor command speed	22 rps(model SRK50 : 23 rps)	0 rps
Indoor fan	Depends on operation mode	Protects the fan tap just before frost prevention control
Outdoor fan	Depends on command speed	Depends on stop mode
4-way valve	OFF	

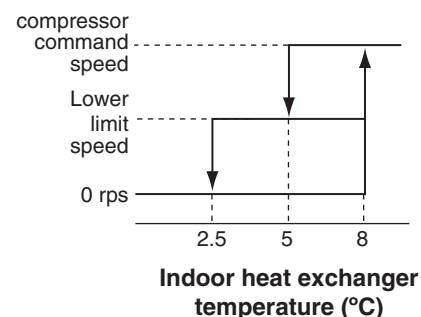

- Notes
- (1) When the indoor heat exchanger temperature is in the range of 2.5~5°C, the speed is reduced by 4 rps at each 20 seconds.
  - (2) When the temperature is lower than 2.5°C, the compressor is stopped.
  - (3) When the indoor heat exchanger temperature is in the range of 5~8°C, the compressor command speed is been maintained.

**(iii) Reset conditions:** When either of the following condition is satisfied.

- 1) The indoor heat exchanger temperature (Th2) is 8°C or higher.
- 2) The compressor command speed is 0 rps.

**(c) Cooling overload protective control**

**(i) Operating conditions:** When the outdoor air temperature (TH2) has become continuously for 30 seconds at 41°C or more, or 47°C or more (model SRK50 : 41°C or more) with the compressor running, the lower limit speed of compressor is brought up.

Item	Model		
	SRK20~35ZM-S	SRK50ZM-S	
Outdoor air temperature	41°C or more	47°C or more	41°C or more
Lower limit speed	30 rps	40 rps	29 rps

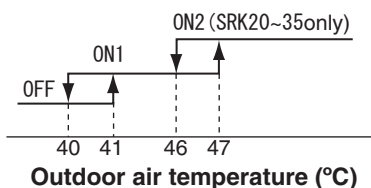

**(ii) Detail of operation**

- 1) The outdoor fan is stepped up by 3 speed step. (Upper limit 7th speed.)
- 2) The lower limit of compressor command speed is set to 30 or 40 (model SRK50 : 29) rps and even if the calculated result becomes lower than that after fuzzy calculation, the speed is kept to 30 or 40 (model SRK50 : 29) rps. However, when the thermo OFF, the speed is reduced to 0 rps.

**(iii) Reset conditions:** When either of the following condition is satisfied.

- 1) The outdoor air temperature is lower than 40°C.
- 2) The compressor command speed is 0 rps.

**(d) Cooling high pressure control**

**(i) Purpose:** Prevents anomalous high pressure operation during cooling.

**(ii) Detector:** Outdoor heat exchanger sensor (TH1)

**(iii) Detail of operation:**

**(Example) Fuzzy**

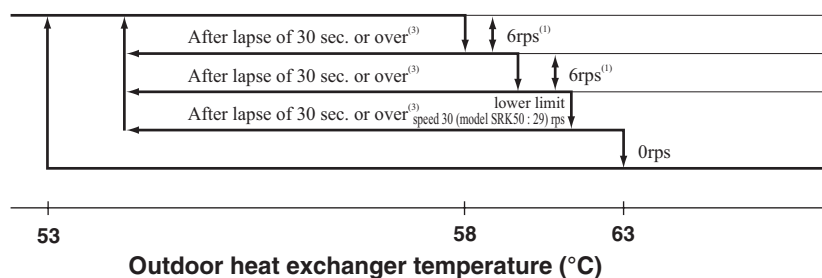

- Notes
- (1) When the outdoor heat exchanger temperature is in the range of 58~63°C, the speed is reduced by 6 rps at each 30 seconds.
  - (2) When the temperature is 63°C or higher, the compressor is stopped.
  - (3) When the outdoor heat exchanger temperature is in the range of 53~58°C, if the compressor command speed is been maintained and the operation has continued for more than 30 seconds at the same speed, it returns to the normal cooling operation.

**(e) Cooling low outdoor air temperature protective control**

**(i) Operating conditions:** When the outdoor air temperature (TH2) is 22°C or lower continues for 20 seconds while the compressor command speed is other than 0 rps.

**(ii) Detail of operation:**

- The lower limit of the compressor command speed is set to 50 <44> (30) rps and even if the speed becomes lower than 50 <44> (30) rps, the speed is kept to 50 <44> (30) rps. However, when the thermo OFF, the speed is reduced to 0 rps.
- The upper limit of the compressor command speed is set to 50 <50> (60) rps and even if the calculated result becomes higher than that after fuzzy calculation, the speed is kept to 50 <50> (60) rps.

Notes (1) Values in < > are for outdoor air temperature is A or B °C  
 (2) Values in ( ) are for outdoor air temperature is C or D °C

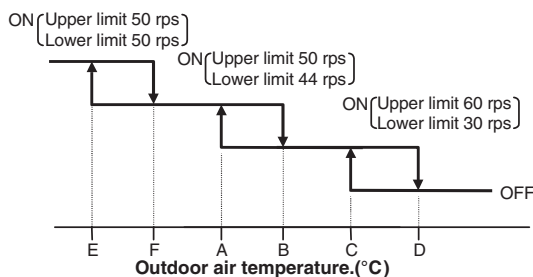

● Values of A, B, C, D, E, F (Models SRK20 ~ 35)

	Outdoor air temperature (°C)					
	E	F	A	B	C	D
First time	-8	-5	0	3	22	25
After the second times	-2	1	5	8	25	28

● Values of A, B, C, D (Model SRK50)

	Outdoor air temperature (°C)			
	A	B	C	D
First time	9	11	22	25
After the second times	16	19	25	28

**(iii) Reset conditions:** When either of the following condition is satisfied

- The outdoor air temperature (TH2) is D °C or higher.
- The compressor command speed is 0 rps.

**(f) Heating high pressure control**

**(i) Purpose:** Prevents anomalous high pressure operation during heating.

**(ii) Detector:** Indoor heat exchanger sensor (Th2)

**(iii) Detail of operation:**

**(Example) Fuzzy**

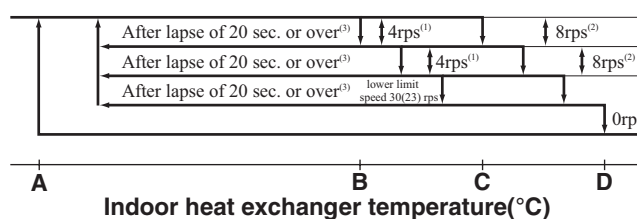

Note (1) Value in ( ) are for the model SRK50.

- Notes (1) When the indoor heat exchanger temperature is in the range of B~C °C, the speed is reduced by 4 rps at each 20 seconds.  
 (2) When the indoor heat exchanger temperature is in the range of C~D °C, the speed is reduced by 8 rps at each 20 seconds. When the temperature is D °C or higher continues for 1 minute, the compressor is stopped.  
 (3) When the indoor heat exchanger temperature is in the range of A~B °C, if the compressor command speed is been maintained and the operation has continued for more than 20 seconds at the same speed, it returns to the normal heating operation.  
 (4) Indoor blower retains the fan tap when it enters in the high pressure control. Outdoor blower is operated in accordance with the speed.

● **Temperature list Models SRK20 ~ 35**

	Unit : °C			
	A	B	C	D
RPSmin < 50	48	53	55	58
50 ≤ RPSmin < 91	48.5	56	58	61
91 ≤ RPSmin < 97	48.5	56 ~ 52.5	58	61
97 ≤ RPSmin < 100	48.5	52.5 ~ 50.8	58 ~ 56.2	61
100 ≤ RPSmin < 115	48.5 ~ 40.1	50.8 ~ 42	56.2 ~ 47.3	61
115 ≤ RPSmin	40.1	42	47.3	61

Note (1) RPSmin: The lower one between the outdoor speed and the compressor command speed

**Model SRK50**

Unit : °C

	<b>A</b>	<b>B</b>	<b>C</b>	<b>D</b>
<b>RPSmin &lt; 40</b>	49	53	55	58
<b>40 ≤ RPSmin &lt; 80</b>	53	57	59	62
<b>80 ≤ RPSmin &lt; 90</b>	53 ~ 47	57 ~ 51	59 ~ 53	58
<b>90 ≤ RPSmin &lt; 102</b>	47 ~ 41	51 ~ 45	53 ~ 47	51
<b>102 ≤ RPSmin</b>	41	45	47	51

Note (1) RPSmin: The lower one between the outdoor speed and the compressor command speed

**(g) Heating overload protective control**

**(i) Indoor unit side**

- 1) **Operating conditions :** When the outdoor air temperature (TH2) is 17°C or higher continues for 30 seconds while the compressor command speed other than 0 rps.
- 2) **Detail of operation :** The indoor fan is stepped up by 1 speed step. (Upper limit 8th speed)
- 3) **Reset conditions :** The outdoor air temperature (TH2) is lower than 16°C.

**(ii) Outdoor unit side**

**• Models SRK20 ~ 35**

- 1) **Operating conditions :** When the outdoor air temperature (TH2) is 22°C or higher continues for 30 seconds while the compressor command speed other than 0 rps.
- 2) **Detail of operation**
  - a) Taking the upper limit of compressor command speed range at 60 rps, if the output speed obtained with the fuzzy calculation exceeds the upper limit, the upper limit value is maintained.
  - b) The lower limit of compressor command speed is set to 40 rps and even if the calculated result becomes lower than that after fuzzy calculation, the speed is kept to 40 rps. However, when the thermo OFF, the speed is reduced to 0 rps.
  - c) Inching prevention control is activated and inching prevention control is carried out with the minimum speed set at 40 rps.
  - d) The outdoor fan is set on 2nd speed.

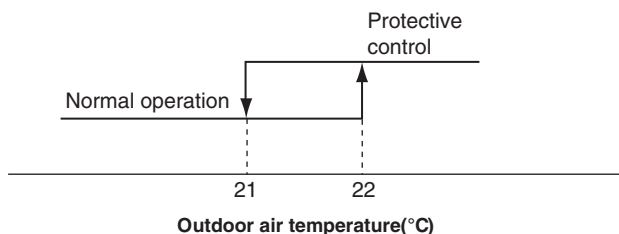

- 3) **Reset conditions:** The outdoor air temperature (TH2) is lower than 21°C.

**• Model SRK50**

- 1) **Operating conditions :** When the outdoor air temperature (TH2) is 11°C or higher continues for 30 seconds while the compressor command speed other than 0 rps.
- 2) **Detail of operation**
  - a) Taking the upper limit of compressor command speed range at 78 rps, if the output speed obtained with the fuzzy calculation exceeds the upper limit, the upper limit value is maintained.
  - b) The lower limit of compressor command speed is set to 30 rps and even if the calculated result becomes lower than that after fuzzy calculation, the speed is kept to 30 rps. However, when the thermo OFF, the speed is reduced to 0 rps.
  - c) Inching prevention control is activated and inching prevention control is carried out with the minimum speed set at 30 rps.



d) The outdoor fan speed.

Protective control	Item	Compressor command speed		Outdoor fan speed
		Low limit	Upper limit	
ON1		30 rps	78 rps	It depends on compressor command speed
ON2		30 rps	51 rps	2nd

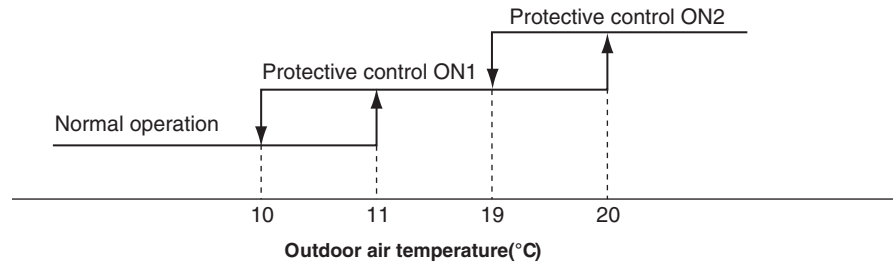

3) **Reset conditions:** The outdoor air temperature (TH2) is lower than 10°C.

(h) Heating low outdoor temperature protective control

• Models SRK20 ~ 35

(i) **Operating conditions:** When the outdoor air temperature (TH2) is lower than -2°C or higher continues for 30 seconds while the compressor command speed is other than 0 rps.

(ii) **Detail of operation:** The lower limit compressor command speed is change as shown in the figure below.

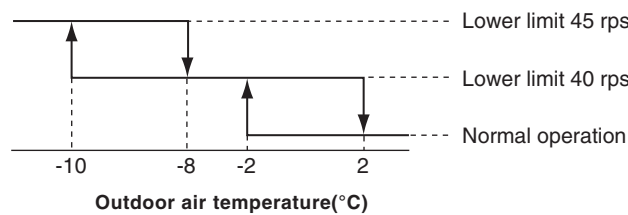

(iii) **Reset conditions:** When either of the following condition is satisfied.

- 1) The outdoor air temperature (TH2) becomes 2°C.
- 2) The compressor command speed is 0 rps.

• Model SRK50

(i) **Operating conditions:** When the outdoor air temperature (TH2) is lower than 4°C or 13°C or higher continues for 30 seconds while the compressor command speed is other than 0 rps.

(ii) **Detail of operation:** The lower limit compressor command speed is change as shown in the figure below.

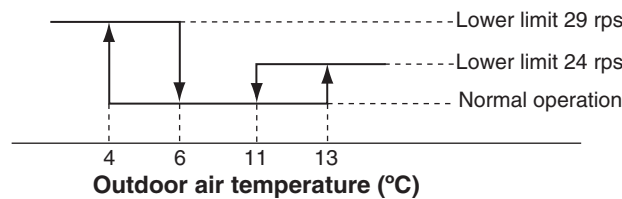

(iii) **Reset conditions:** When either of the following condition is satisfied.

- 1) The outdoor air temperature (TH2) becomes 6°C ~ 11°C.
- 2) The compressor command speed is 0 rps.

**(i) Compressor overheat protection**

**(i) Purpose:** It is designed to prevent deterioration of oil, burnout of motor coil and other trouble resulting from the compressor overheat.

**(ii) Detail of operation**

1) Speeds are controlled with temperature detected by the sensor (TH3) mounted on the discharge pipe.

**(Example) Fuzzy**

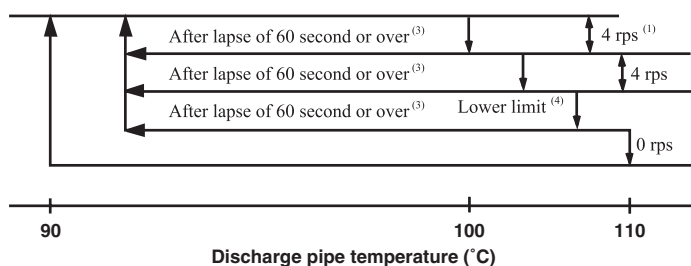

- Notes (1) When the discharge pipe temperature is in the range of 100~110°C, the speed is reduced by 4 rps.  
 (2) When the discharge pipe temperature is raised and continues operation for 20 seconds without changing, then the speed is reduced again by 4 rps.  
 (3) If the discharge pipe temperature is in the range of 90~100°C even when the compressor command speed is maintained for 60 second when the temperature is in the range of 90~100°C, the speed is raised by 1 rps and kept at that speed for 60 second. This process is repeated until the command speed is reached.  
 (4) Lower limit speed

Model	Item	Cooling	Heating
		SRK20 ~ 35	20 rps
Lower limit speed	SRK50	24 rps	29 rps

2) If the temperature of 110°C is detected by the sensor on the discharge pipe, then the compressor will stop immediately. When the discharge pipe temperature drops and the time delay of 3 minutes is over, the unit starts again within 1 hour but there is no start at the third time.

**(j) Current safe**

**(i) Purpose:** Current is controlled not to exceed the upper limit of the setting operation current.

**(ii) Detail of operation:** Input current to the converter is monitored with the current sensor fixed on the printed circuit board of the outdoor unit and, if the operation current value reaches the limiting current value, the compressor command speed is reduced.

If the mechanism is actuated when the compressor command speed is less than 30 rps, the compressor is stopped immediately. Operation starts again after a delay time of 3 minutes.

**(k) Current cut**

**(i) Purpose:** Inverter is protected from overcurrent.

**(ii) Detail of operation:** Output current from the inverter is monitored with a shunt resistor and, if the current exceeds the setting value, the compressor is stopped immediately. Operation starts again after a delay time of 3 minutes.

**(l) Outdoor unit failure**

This is a function for determining when there is trouble with the outdoor unit during air conditioning.

The compressor is stopped if any one of the following in item (i), (ii) is satisfied. Once the unit is stopped by this function, it is not restarted.

- (i) When the input current is measured at 1 A or less for 3 continuous minutes or more.
- (ii) If the outdoor unit sends a 0 rps signal to the indoor unit 3 times or more within 20 minutes of the power being turned on.

**(m) Indoor fan motor protection**

When the air conditioner is operating and the indoor fan motor is turned ON, if the indoor fan motor has operated at 300 min<sup>-1</sup> or under for more than 30 seconds, the unit enters first in the stop mode and then stops the entire system.

**(n) Serial signal transmission error protection**

**(i) Purpose:** Prevents malfunction resulting from error on the indoor ↔ outdoor signals.

**(ii) Detail of operation:** If the compressor is operating and a serial signal cannot be received from the indoor control with outdoor control having serial signals continues for 7 minute and 35 seconds, the compressor is stopped.

After the compressor has been stopped, it will be restarted after the compressor start delay if a serial signal can be received again from the indoor control.

**(o) Rotor lock**

If the motor for the compressor does not turn after it has been started, it is determined that a compressor lock has occurred and the compressor is stopped.

**(p) Outdoor fan motor protection**

If the outdoor fan motor has operated at 75 min<sup>-1</sup> or under for more than 30 seconds, the compressor and fan motor are stopped.

**(q) Outdoor fan control at low outdoor temperature**

**(i) Cooling**

**1) Operating conditions:** When the outdoor air temperature (TH2) is 22°C or lower continues for 30 seconds while the compressor command speed is other than 0 rps.

**2) Detail of operation:** After the outdoor fan operates at A speed for 60 seconds; the corresponding outdoor heat exchanger temperature shall implement the following controls.

● Value of A

	Outdoor fan
Outdoor temperature > 10°C	2nd speed
Outdoor temperature ≤ 10°C	1st speed

- a) Outdoor heat exchanger temperature (TH1) ≤ 21°C  
After the outdoor fan speed drops (down) to 1 speed for 60 seconds; if the outdoor heat exchanger temperature is lower than 21°C, gradually reduce the outdoor fan speed by 1 speed. (Lower limit 1st speed)
- b) 21°C < Outdoor heat exchanger temperature (TH1) ≤ 38°C  
After the outdoor fan speed maintains at A speed for 20 seconds; if the outdoor heat exchanger temperature is 21°C~38°C, maintain outdoor fan speed.
- c) Outdoor heat exchanger temperature (TH1) > 38°C  
After the outdoor fan speed rises (up) to 1 speed for 60 seconds; if the outdoor heat exchanger temperature is higher than 38°C, gradually increase outdoor fan speed by 1 speed. (Upper limit 3rd speed)

**3) Reset conditions:** When either of the following conditions is satisfied

- a) The outdoor air temperature (TH2) is 25°C or higher.
- b) The compressor command speed is 0 rps.

**(ii) Heating**

**1) Operating conditions:** When the outdoor air temperature (TH2) is 4°C or lower continues for 30 seconds while the compressor command speed is other than 0 rps.

**2) Detail of operation:** The outdoor fan is stepped up by 2 speed step at each 20 seconds. (Upper limit 8th speed)

**3) Reset conditions:** When either of the following conditions is satisfied

- a) The outdoor air temperature (TH2) is 6°C or higher.
- b) The compressor command speed is 0 rps.

**(r) Refrigeration cycle system protection****(i) Starting conditions**

- 1) When 5 minutes have elapsed after the compressor ON or the completion of the defrost control
- 2) Other than the defrost control
- 3) When, after meeting the conditions of 1) and 2) above, the compressor speed, indoor temperature (Th1) and indoor heat exchanger temperature (Th2) have met the conditions in the following table for 5 minutes:

Operation mode	Compressor speed (N)	Indoor temperature (Th1)	Indoor temperature (Th1)/ Indoor heat exchanger temperature (Th2)
Cooling	$50 \leq N$	$10 \leq Th1 \leq 40$	$Th1 - 4 < Th2$
Heating <sup>(1)</sup>	$50 \leq N$	$0 \leq Th1 \leq 40$	$Th2 < Th1 + 6$

Note (1) Except that the fan speed is HI in heating operation.

**(ii) Contents of control**

- 1) When the conditions of (i) above are met, the compressor stops.
- 2) Error stop occurs when the compressor has stopped 3 times within 60 minutes.

**(iii) Resetting condition**

When the compressor has been turned OFF

# 10. MAINTENANCE DATA

## (1) Cautions

- (a) If you are disassembling and checking an air conditioner, be sure to turn off the power before beginning. When working on indoor units, let the unit sit for about 1 minute after turning off the power before you begin work. When working on an outdoor unit, there may be an electrical charge applied to the main circuit (electrolytic condenser), so begin work only after discharging this electrical charge (to DC 10 V or lower).
- (b) When taking out printed circuit boards, be sure to do so without exerting force on the circuit boards or package components.
- (c) When disconnecting and connecting connectors, take hold of the connector housing and do not pull on the lead wires.

## (2) Items to check before troubleshooting

- (a) Have you thoroughly investigated the details of the trouble which the customer is complaining about?
- (b) Is the air conditioner running? Is it displaying any self-diagnosis information?
- (c) Is a power supply with the correct voltage connected?
- (d) Are the control lines connecting the indoor and outdoor units wired correctly and connected securely?
- (e) Is the outdoor unit's service valve open?

## (3) Troubleshooting procedure (If the air conditioner does not run at all)

If the air conditioner does not run at all, diagnose the trouble using the following troubleshooting procedure. If the air conditioner is running but breaks down, proceed to troubleshooting step (4).

**Important** When all the following conditions are met, we say that the air conditioner will not run at all.

- (a) The RUN light does not light up.
- (b) The flaps do not open.
- (c) The indoor unit fan motors do not run.
- (d) The self-diagnosis display does not function.

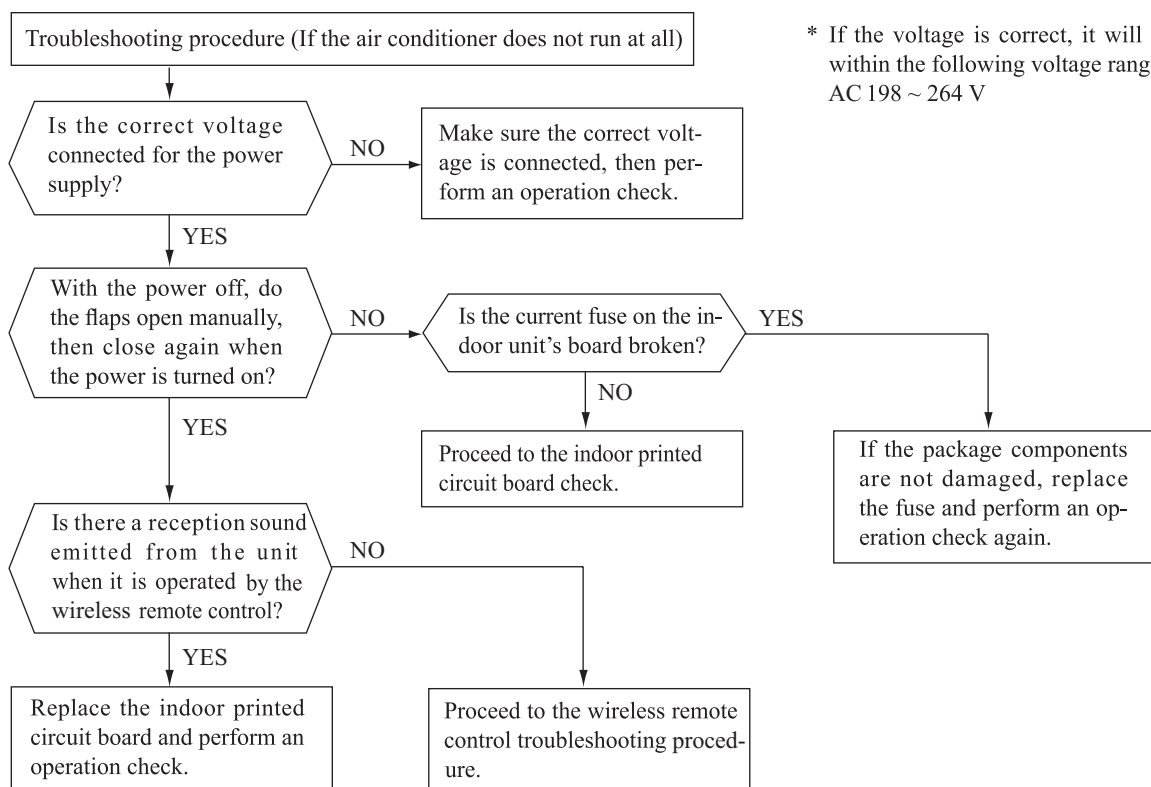

(4) Troubleshooting procedure (If the air conditioner runs)

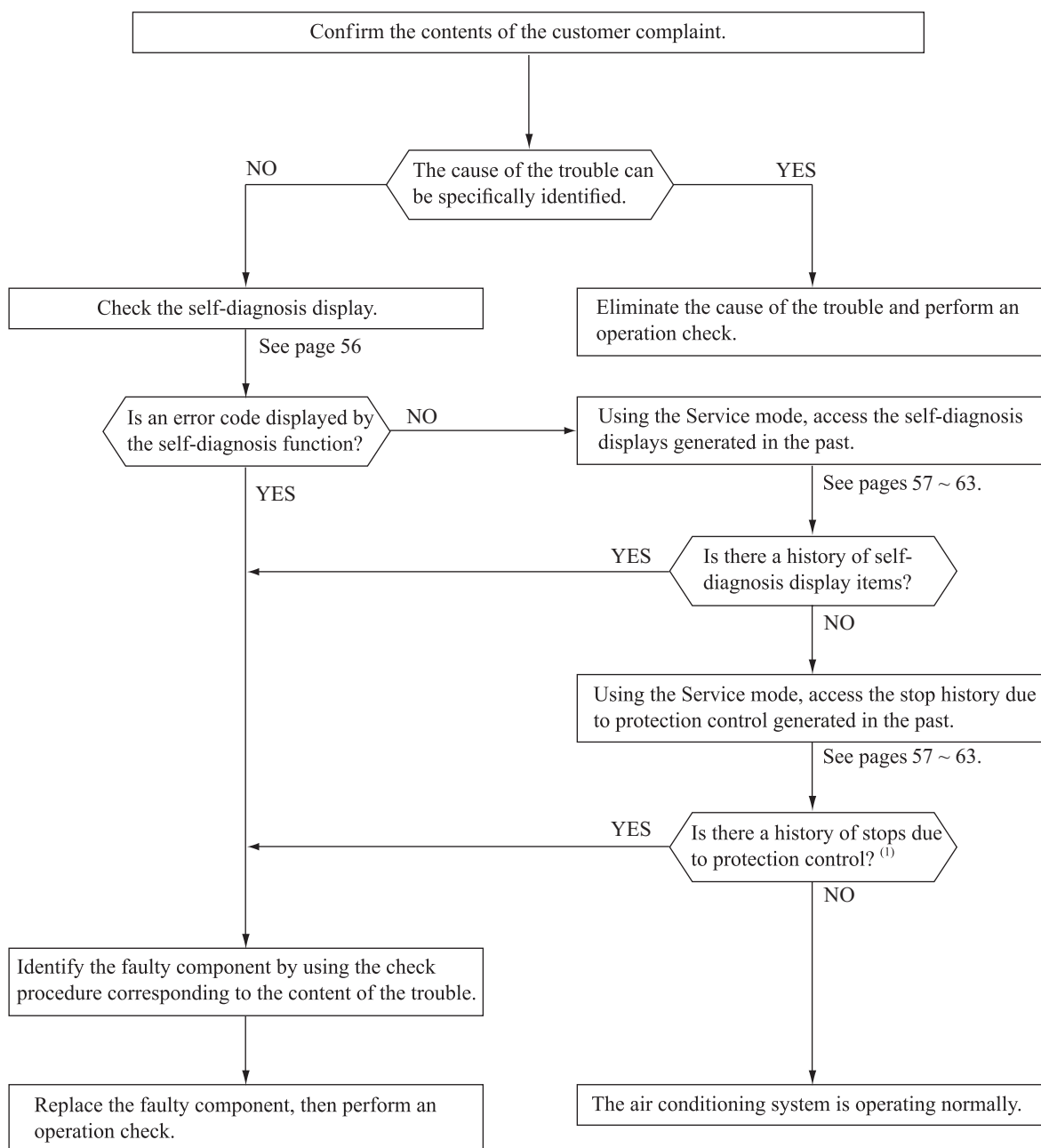

Note (1) Even in cases where only intermittent stop data are generated, the air conditioning system is normal. However, if the same protective operation recurs repeatedly (3 or more times), it will lead to customer complaints. Judge the conditions in comparison with the contents of the complaints.

**(5) Self-diagnosis table**

When this air conditioner performs an emergency stop, the reason why the emergency stop occurred is displayed by the flashing of display lights. If the air conditioner is operated using the remote control 3 minutes or more after the emergency stop, the trouble display stops and the air conditioner resumes operation. <sup>(1)</sup>

Indoor unit display panel		Outdoor <sup>(3)</sup> control PCB	Wired <sup>(2)</sup> remote control display	Description of trouble	Cause	Display (flashing) condition
RUN light	TIMER light	Red LED				
1-time flash	ON	—	—	Heat exchanger sensor 1 error	<ul style="list-style-type: none"> <li>Broken heat exchanger sensor 1 wire, poor connector connection</li> <li>Indoor PCB is faulty</li> </ul>	When a heat exchanger sensor 1 wire disconnection is detected while operation is stopped. (If a temperature of $-28^{\circ}\text{C}$ or lower is detected for 15 seconds, it is judged that the wire is disconnected.) (Not displayed during operation.)
2-time flash	ON	—	—	Room temperature sensor error	<ul style="list-style-type: none"> <li>Broken room temperature sensor wire, poor connector connection</li> <li>Indoor PCB is faulty</li> </ul>	When a room temperature sensor wire disconnection is detected while operation is stopped. (If a temperature of $-45^{\circ}\text{C}$ or lower is detected for 15 seconds, it is judged that the wire is disconnected.) (Not displayed during operation.)
3-time flash	ON	—	—	Heat exchanger sensor 2 error	<ul style="list-style-type: none"> <li>Broken heat exchanger sensor 2 wire, poor connector connection</li> <li>Indoor PCB is faulty</li> </ul>	When a heat exchanger sensor 2 wire disconnection is detected while operation is stopped. (If a temperature of $-28^{\circ}\text{C}$ or lower is detected for 15 seconds, it is judged that the wire is disconnected.) (Not displayed during operation.)
6-time flash	ON	—	E 16	Indoor fan motor error	<ul style="list-style-type: none"> <li>Defective fan motor, poor connector connection</li> </ul>	When conditions for turning the indoor unit's fan motor on exist during air conditioner operation, an indoor unit fan motor speed of $300\text{ min}^{-1}$ or lower is measured for 30 seconds or longer. (The air conditioner stops.)
Keeps flashing	1-time flash	8-time flash	E 38	Outdoor air temperature sensor error	<ul style="list-style-type: none"> <li>Broken outdoor air temp. sensor wire, poor connector connection</li> <li>Outdoor PCB is faulty</li> </ul>	$-55^{\circ}\text{C}$ or lower is detected for 5 seconds continuously 3 times within 40 minutes after initial detection of this anomalous temperature. Or $-55^{\circ}\text{C}$ or lower is detected for within 20 seconds after power ON. (The compressor is stopped.)
Keeps flashing	2-time flash	8-time flash	E 37	Outdoor heat exchanger sensor error	<ul style="list-style-type: none"> <li>Broken heat exchanger sensor wire, poor connector connection</li> <li>Outdoor PCB is faulty</li> </ul>	$-55^{\circ}\text{C}$ or lower is detected for 5 seconds continuously 3 times within 40 minutes after initial detection of this anomalous temperature. Or $-55^{\circ}\text{C}$ or lower is detected for within 20 seconds after power ON. (The compressor is stopped.)
Keeps flashing	4-time flash	8-time flash	E 39	Discharge pipe sensor error	<ul style="list-style-type: none"> <li>Broken discharge pipe sensor wire, poor connector connection</li> <li>Outdoor PCB is faulty</li> </ul>	$-25^{\circ}\text{C}$ or lower is detected for 5 seconds continuously 3 times within 40 minutes after initial detection of this anomalous temperature. (The compressor is stopped.)
ON	1-time flash	1-time flash	E 42	Current cut	<ul style="list-style-type: none"> <li>Compressor locking, open phase on compressor output, short circuit on power transistor, service valve is closed</li> </ul>	The compressor output current exceeds the set value during compressor start. (The air conditioner stops.)
ON	2-time flash	2-time flash	E 59	Trouble of outdoor unit	<ul style="list-style-type: none"> <li>Broken compressor wire</li> <li>Compressor blockage</li> </ul>	When there is an emergency stop caused by trouble in the outdoor unit, or the input current value is found to be lower than the set value. (The air conditioner stops.)
ON	3-time flash	3-time flash	E 58	Current safe stop	<ul style="list-style-type: none"> <li>Overload operation</li> <li>Overcharge</li> <li>Compressor locking</li> </ul>	When the compressor command speed is lower than the set value and the current safe has operated. (the compressor stops)
ON	4-time flash	1-time flash	E 51	Power transistor error	<ul style="list-style-type: none"> <li>Broken power transistor</li> </ul>	When the power transistor is judged breakdown while compressor starts. (The compressor is stopped.)
ON	5-time flash	5-time flash	E 36	Over heat of compressor	<ul style="list-style-type: none"> <li>Gas shortage, defective discharge pipe sensor, service valve is closed</li> </ul>	When the value of the discharge pipe sensor exceeds the set value. (The air conditioner stops.)
ON	6-time flash	6-time flash	E 5	Error of signal transmission	<ul style="list-style-type: none"> <li>Defective power supply, Broken signal wire, defective indoor/outdoor PCB</li> </ul>	When there is no signal between the indoor PCB and outdoor PCB for 10 seconds or longer (when the power is turned on), or when there is no signal for 7 minute 35 seconds or longer (during operation) (the compressor is stopped).
ON	7-time flash	ON	E 48	Outdoor fan motor error	<ul style="list-style-type: none"> <li>Defective fan motor, poor connector connection</li> </ul>	When the outdoor unit's fan motor speed continues for 30 seconds or longer at $75\text{ min}^{-1}$ or lower. (3 times) (The air conditioner stops.)
ON	Keeps flashing	2-time flash	E 35	Cooling high pressure protecton	<ul style="list-style-type: none"> <li>Overload operation, overcharge</li> <li>Broken outdoor heat exchange sensor wire</li> <li>Service valve is closed</li> </ul>	When the value of the outdoor heat exchanger sensor exceeds the set value.
2-time flash	2-time flash	7-time flash	E 60	Rotor lock	<ul style="list-style-type: none"> <li>Defective compressor</li> <li>Open phase on compressor</li> <li>Defective outdoor PCB</li> </ul>	If the compressor motor's magnetic pole positions cannot be correctly detected when the compressor starts. (The air conditioner stops.)
5-time flash	ON	2-time flash	E 47	Active filter voltage error	<ul style="list-style-type: none"> <li>Defective active filter</li> </ul>	When the wrong voltage connected for the power supply. When the outdoor PCB is faulty.
7-time flash	ON	2-time flash	E 57	Refrigeration cycle system protective control	<ul style="list-style-type: none"> <li>Service valve is closed.</li> <li>Refrigerant is insufficient</li> </ul>	When refrigeration cycle system protective control operates.
7-time flash	1-time flash	4-time flash	E 40	Service valve (gas side) closed operation	<ul style="list-style-type: none"> <li>Service valve (gas side) closed</li> <li>Defective outdoor PCB</li> </ul>	If the output current of inverter exceeds the specifications, it makes the compressor stopping. (In heating mode). After 3-minute delay, the compressor restarts, but if this anomaly occurs 2 times within 20 minute after the initial detection.
—	—	—	E 1	Error of wired remote control wiring	<ul style="list-style-type: none"> <li>Broken wired remote control wire, defective indoor PCB</li> </ul>	The wired remote control wire Y is open. The wired remote control wires X and Y are reversely connected. Noise is penetrating the wired remote control lines. The wired remote control or indoor PCB is faulty. (The communications circuit is faulty.)

Notes (1)The air conditioner cannot be restarted using the remote control for 3 minutes after operation stops.

(2)The wired remote control is optional parts.

(3)Model SRC50ZM-S only.

**(6) Service mode (Trouble mode access function)**

This air conditioner is capable of recording error displays and protective stops (service data) which have occurred in the past. If self-diagnosis displays cannot be confirmed, it is possible to get a grasp of the conditions at the time trouble occurred by checking these service data.

**(a) Explanation of terms**

Term	Explanation
<b>Service mode</b>	The service mode is the mode where service data are displayed by flashing of the display lights when the operations in item (b) below are performed with the indoor controller.
<b>Service data</b>	These are the contents of error displays and protective stops which occurred in the past in the air conditioner system. Error display contents and protective stop data from past anomalous operations of the air conditioner system are saved in the indoor unit controller's non-volatile memory (memory which is not erased when the power goes off). There are two types of data, self-diagnosis data and stop data, described below.
<b>Self-diagnosis data</b>	These are the data which display the reason why a stop occurred when an error display(self-diagnosis display) occurred in an indoor unit. Data are recorded for up to 5 previous occurrences. Data which are older than the 5th previous occurrence are erased. In addition, data on the temperature of each sensor (room temperature, indoor heat exchanger, outdoor heat exchanger, outdoor air temperature, discharge pipe), remote control information (operation switching, fan speed switching) are recorded when trouble occurs, so more detailed information can be checked.
<b>Stop data</b>	These are the data which display the reason by a stop occurred when the air conditioning system performed protective stops, etc. in the past. Even if stop data alone are generated, the system restarts automatically. (After executing the stop mode while the display is normal, the system restarts automatically.) Data for up to 10 previous occasions are stored. Data older than the 10th previous occasion are erased. ( Important) In cases where transient stop data only are generated, the air conditioner system may still be normal. However, if the same protective stop occurs frequently (3 or more times), it could lead to customer complaints.

**(b) Service mode display procedure**

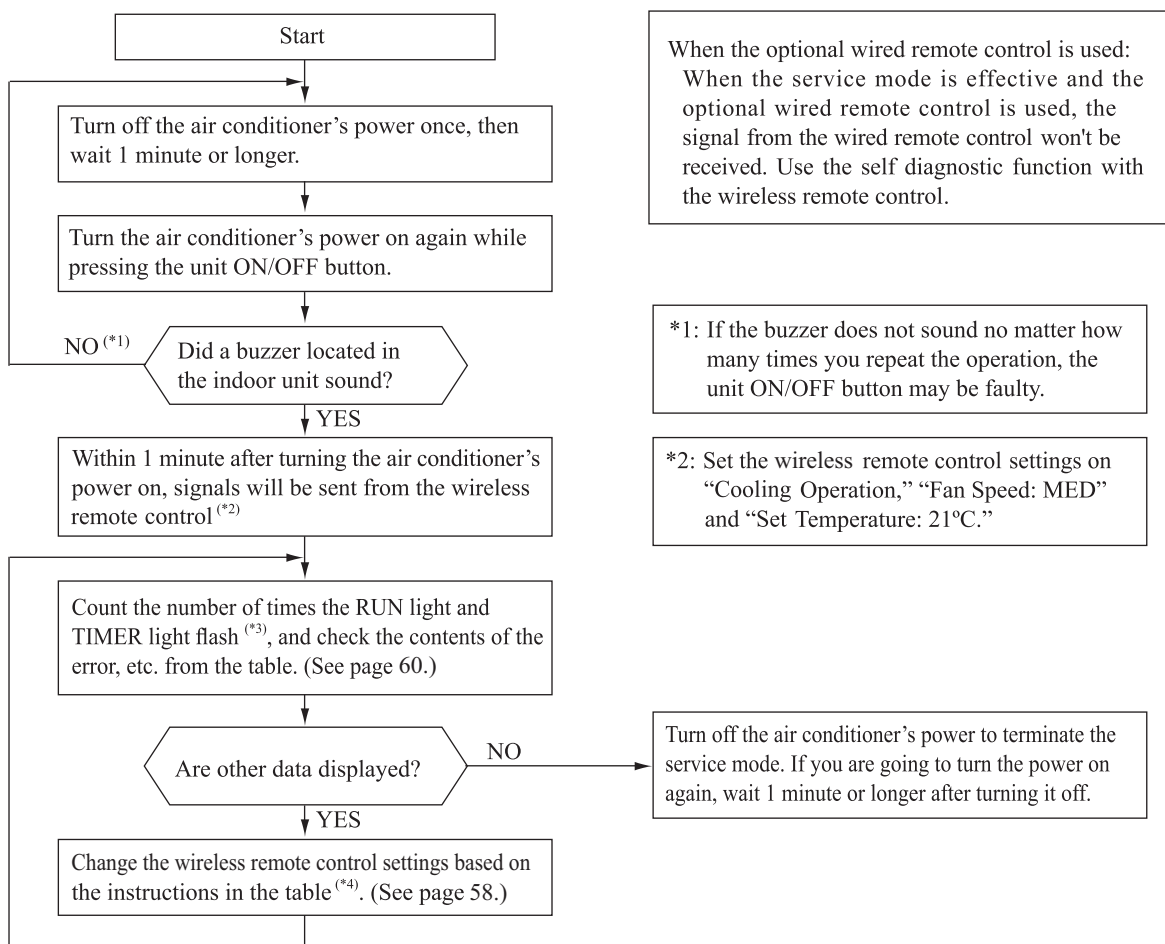



\*3: To count the number of flashes in the service mode, count the number of flashes after the light lights up for 1.5 second initially (start signal). (The time that the light lights up for 1.5 second (start signal) is not counted in the number of flashes.)

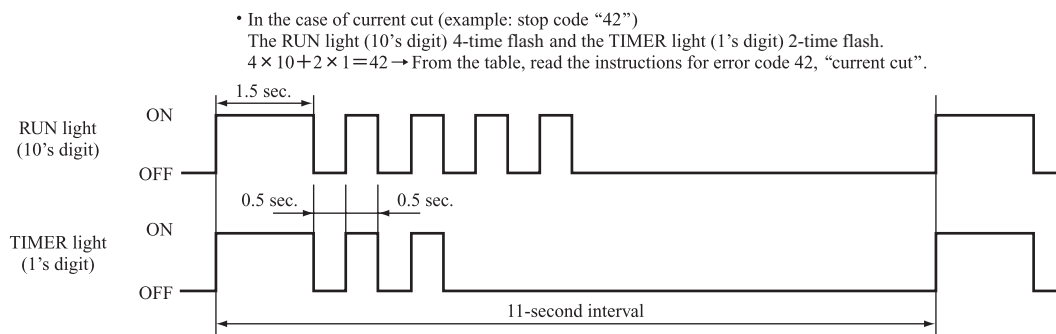

\*4: When in the service mode, when the wireless remote control settings (operation mode, fan speed mode, temperature setting) are set as shown in the following table and sent to the air conditioner unit, the unit switches to display of service data.

**(i) Self-diagnosis data**

What are Self-.....These are control data (reasons for stops, temperature at each sensor, wireless remote control information) diagnosis Data? from the time when there were error displays (abnormal stops) in the indoor unit in the past.

Data from up to 5 previous occasions are stored in memory. Data older than the 5th previous occasion are erased.

The temperature setting indicates how many occasions previous to the present setting the error display data are and the operation mode and fan speed mode data show the type of data.

Wireless remote control setting		Contents of output data
Operation mode	Fan speed mode	
Cooling	MED	Displays the reason for stopping display in the past (error code).
	HI	Displays the room temperature sensor temperature at the time the error code was displayed in the past.
	AUTO	Displays the indoor heat exchanger sensor temperature at the time the error code was displayed in the past.
Heating	LO	Displays the wireless remote control information at the time the error code was displayed in the past.
	MED	Displays the outdoor air temperature sensor temperature at the time the error code was displayed in the past.
	HI	Displays the outdoor heat exchanger sensor temperature at the time the error code was displayed in the past.
	AUTO	Displays the discharge pipe sensor temperature at the time the error code was displayed in the past.

Wireless remote control setting	Indicates the number of occasions previous to the present the error display data are from.
Temperature setting	
21°C	1 time previous (previous time)
22°C	2 times previous
23°C	3 times previous
24°C	4 times previous
25°C	5 times previous

**Only for indoor heat exchanger sensor 2**

Wireless remote control setting	Indicates the number of occasions previous to the present the error display data are from.
Temperature setting	
26°C	1 time previous (previous time)
27°C	2 times previous
28°C	3 times previous
29°C	4 times previous
30°C	5 times previous

(Example)

Wireless remote control setting			Displayed data
Operation mode	Fan speed mode	Temperature setting	
Cooling	MED	21°C	Displays the reason for the stop (error code) the previous time an error was displayed.
		22°C	Displays the reason for the stop (error code) 2 times previous when an error was displayed.
		23°C	Displays the reason for the stop (error code) 3 times previous when an error was displayed.
		24°C	Displays the reason for the stop (error code) 4 times previous when an error was displayed.
		25°C	Displays the reason for the stop (error code) 5 times previous when an error was displayed.

(ii) Stop data

Wireless remote control setting			Displayed data
Operation mode	Fan speed mode	Temperature setting	
Cooling	LO	21°C	Displays the reason for the stop (stop code) the previous time when the air conditioner was stopped by protective stop control.
		22°C	Displays the reason for the stop (stop code) 2 times previous when the air conditioner was stopped by protective stop control.
		23°C	Displays the reason for the stop (stop code) 3 times previous when the air conditioner was stopped by protective stop control.
		24°C	Displays the reason for the stop (stop code) 4 times previous when the air conditioner was stopped by protective stop control.
		25°C	Displays the reason for the stop (stop code) 5 times previous when the air conditioner was stopped by protective stop control.
		26°C	Displays the reason for the stop (stop code) 6 times previous when the air conditioner was stopped by protective stop control.
		27°C	Displays the reason for the stop (stop code) 7 times previous when the air conditioner was stopped by protective stop control.
		28°C	Displays the reason for the stop (stop code) 8 times previous when the air conditioner was stopped by protective stop control.
		29°C	Displays the reason for the stop (stop code) 9 times previous when the air conditioner was stopped by protective stop control.
		30°C	Displays the reason for the stop (stop code) 10 times previous when the air conditioner was stopped by protective stop control.

(c) **Error code, stop code table** (Assignment of error codes and stop codes is done in common for all models.)

Number of flashes when in service mode		Stop code or Error code	Error content	Cause	Occurrence conditions	Error display	Auto recovery
RUN light (10's digit)	TIMER light (1's digit)						
OFF	OFF	0	Normal	—	—	—	—
	5-time flash	05	Can not receive signals for 35 seconds (if communications have recovered)	Power supply is faulty. Power supply cables and signal lines are improperly wired. Indoor or outdoor PCB are faulty.	When 35 seconds passes without communications signals from either the outdoor unit or the indoor unit being detected correctly.	○	—
3-time flash	5-time flash	35	Cooling high pressure control	Cooling overload operation. Outdoor unit fan speed drops. Outdoor heat exchanger sensor is short circuit.	When the outdoor heat exchanger sensor's value exceeds the set value.	○ (5 times)	○
	6-time flash	36	Compressor overheat 110°C	Refrigerant is insufficient. Discharge pipe sensor is faulty. Service valve is closed.	When the discharge pipe sensor's value exceeds the set value.	○ (2 times)	○
	7-time flash	37	Outdoor heat exchanger sensor is abnormal	Outdoor heat exchanger sensor wire is disconnected. Connector connections are poor. Outdoor PCB is faulty.	-55°C or lower is detected for 5 seconds continuously 3 times within 40 minutes after initial detection of this anomalous temperature. Or -55°C lower is detected for 5 seconds continuously within 20 seconds after power ON.	○ (3 times)	○
	8-time flash	38	Outdoor air temperature sensor is abnormal	Outdoor air temperature sensor wire is disconnected. Connector connections are poor. Outdoor PCB is faulty.	-55°C or lower is detected for 5 seconds continuously 3 times within 40 minutes after initial detection of this anomalous temperature. Or -55°C lower is detected for 5 seconds continuously within 20 seconds after power ON.	○ (3 times)	○
	9-time flash	39	Discharge pipe sensor is abnormal (anomalous stop)	Discharge pipe sensor wire is disconnected. Connector connections are poor. Outdoor PCB is faulty.	-25°C or lower is detected for 5 seconds continuously 3 times within 40 minutes after initial detection of this anomalous temperature.	○ (3 times)	○
4-time flash	OFF	40	Service valve (gas side) closed operation	Service valve (gas side) closed Outdoor PCB is faulty.	If the inverter output current value exceeds the setting value within 80 seconds after the compressor ON in the heating mode, the compressor stops.	○ (2 times)	○
	2-time flash	42	Current cut	Compressor lock. Compressor wiring short circuit. Compressor output is open phase. Outdoor PCB is faulty. Service valve is closed. Electronic expansion valve is faulty. Compressor is faulty.	Compressor start fails 42 times in succession and the reason for the final failure is current cut.	○ (2 times)	○
	7-time flash	47	Active filter voltage error	Defective active filter	When the wrong voltage connected for the power supply. When the outdoor PCB is faulty.	○	—
	8-time flash	48	Outdoor unit's fan motor is abnormal	Outdoor fan motor is faulty. Connector connections are poor. Outdoor PCB is faulty.	When a fan speed of 75 min <sup>-1</sup> or lower continues for 30 seconds or longer.	○ (3 times)	○
5-time flash	1-time flash	51	Short circuit in the power transistor (high side) Current cut circuit breakdown	Outdoor PCB is faulty. Power transistor is damaged.	When it is judged that the power transistor was damaged at the time the compressor started.	○	—
	7-time flash	57	Refrigeration cycle system protective control	Service valve is closed. Refrigerant is insufficient.	When refrigeration cycle system protective control operates.	○ (3 times)	○
	8-time flash	58	Current safe	Refrigerant is overcharge. Compressor lock. Overload operation.	When there is a current safe stop during operation.	—	○
	9-time flash	59	Compressor wiring is unconnection Voltage drop Low speed protective control	Compressor wiring is disconnected. Power transistor is damaged. Power supply construction is defective. Outdoor PCB is faulty. Compressor is faulty.	When the current is 1A or less at the time the compressor started. When the power supply voltage drops during operation. When the compressor command speed is lower than 32 rps for 60 minutes.	○	○
6-time flash	OFF	60	Rotor lock	Compressor is faulty. Compressor output is open phase. Electronic expansion valve is faulty. Overload operation. Outdoor PCB is faulty.	After the compressor starts, when the compressor stops due to rotor lock.	○ (2 times)	○
	1-time flash	61	Connection lines between the indoor and outdoor units are faulty	Connection lines are faulty. Indoor or outdoor PCB are faulty.	When 10 seconds passes after the power is turned on without communications signals from the indoor or outdoor unit being detected correctly.	○	—
	2-time flash	62	Serial transmission error	Indoor or outdoor PCB are faulty. Noise is causing faulty operation.	When 7 minute 35 seconds passes without communications signals from either the outdoor unit or the indoor unit being detected correctly.	○	—
8-time flash	OFF	80	Indoor unit's fan motor is abnormal	Indoor fan motor is faulty. Connector connections are poor. Indoor PCB is faulty.	When the indoor unit's fan motor is detected to be running at 300 min <sup>-1</sup> or lower speed with the fan motor in the ON condition while the air conditioner is running.	○	—
	2-time flash	82	Indoor heat exchanger sensor is abnormal (anomalous stop)	Indoor heat exchanger sensor wire is disconnected. Connector connections are poor.	When a temperature of -28°C or lower is sensed continuously for 40 minutes during heating operation. (the compressor stops).	○	—
	4-time flash	84	Anti-condensation control	High humidity condition. Humidity sensor is faulty.	Anti-condensation prevention control is operating.	—	○
	5-time flash	85	Anti-frost control	Indoor unit fan speed drops. Indoor heat exchanger sensor is broken wire.	When the anti-frost control operates and the compressor stops during cooling operation.	—	○
	6-time flash	86	Heating high pressure control	Heating overload operation. Indoor unit fan speed drops. Indoor heat exchanger sensor is short circuit.	When high pressure control operates during heating operation and the compressor stops.	—	○

Notes (1) The number of flashes when in the Service Mode do not include the 1.5 second period when the lights light up at first (start signal). (See the example shown below.)

- In the case of current cut (example: stop code “42”)
  - The RUN light (10’s digit) 4-time flash and the TIMER light (1’s digit) 2-time flash.
  - $4 \times 10 + 2 \times 1 = 42 \rightarrow$  From the table, read the instructions for error code 42, “current cut”.

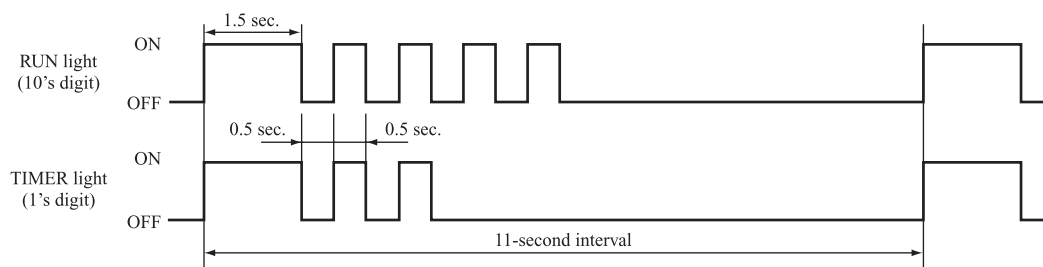

- (2) Error display:   
 – Is not displayed. (automatic recovery only)   
 Displayed.   
 If there is a ( ) displayed, the error display shows the number of times that an auto recovery occurred for the same reason has reached the number of times in ( ).   
 If no ( ) is displayed, the error display shows that the trouble has occurred once.
- (3) Auto Recovery:   
 – Does not occur   
 Auto recovery occurs.

**(d) Operation mode, Fan speed mode information tables**

(i) Operation mode

Display pattern when in service mode	Operation mode when there is an abnormal stop
<b>RUN light (10's digit)</b>	
—	AUTO
1-time flash	DRY
2-time flash	COOL
3-time flash	FAN
4-time flash	HEAT

(ii) Fan speed mode

Display pattern when in service mode	Fan speed mode when there is an abnormal stop
<b>TIMER light (1's digit)</b>	
—	AUTO
2-time flash	HI
3-time flash	MED
4-time flash	LO
5-time flash	ULO
6-time flash	HI POWER
7-time flash	ECONO

\* If no data are recorded (error code is normal), the information display in the operation mode and fan speed mode becomes as follows.

Mode	Display when error code is normal.
<b>Operation mode</b>	AUTO
<b>Fan speed mode</b>	AUTO

(Example): Operation mode: COOL, Fan speed mode: HI

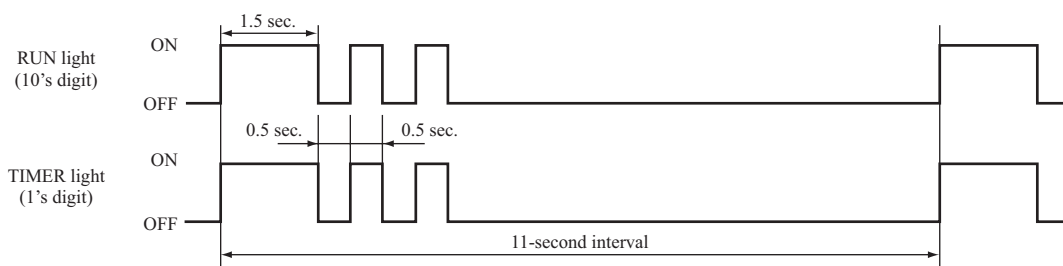

(e) Temperature information

(i) Room temperature sensor, indoor heat exchanger sensor, outdoor air temperature sensor, outdoor heat exchanger sensor temperature

Units: °C

Buzzer sound	RUN light (10's digit)	TIMER light (1's digit)										
		0	1	2	3	4	5	6	7	8	9	
Yes (sounds for 0.1 second)	6	-60	-61	-62	-63	-64						
	5	-50	-51	-52	-53	-54	-55	-56	-57	-58	-59	
	4	-40	-41	-42	-43	-44	-45	-46	-47	-48	-49	
	3	-30	-31	-32	-33	-34	-35	-36	-37	-38	-39	
	2	-20	-21	-22	-23	-24	-25	-26	-27	-28	-29	
	1	-10	-11	-12	-13	-14	-15	-16	-17	-18	-19	
	0		-1	-2	-3	-4	-5	-6	-7	-8	-9	
No (does not sound)	0	0	1	2	3	4	5	6	7	8	9	
	1	10	11	12	13	14	15	16	17	18	19	
	2	20	21	22	23	24	25	26	27	28	29	
	3	30	31	32	33	34	35	36	37	38	39	
	4	40	41	42	43	44	45	46	47	48	49	
	5	50	51	52	53	54	55	56	57	58	59	
	6	60	61	62	63	64	65	66	67	68	69	
	7	70	71	72	73	74	75	76	77	78	79	
	8	80	81	82	83	84	85	86	87	88	89	
	9	90	91	92	93	94	95	96	97	98	99	

\* If no data are recorded (error code is normal), the display for each temperature information becomes as shown below.

Sensor name	Sensor value displayed when the error code is normal
Room temperature sensor	-64°C
Indoor heat exchanger sensor	-64°C
Outdoor air temperature sensor	-64°C
Outdoor heat exchanger sensor	-64°C

(Example) Outdoor heat exchanger temperature data: “-9°C”

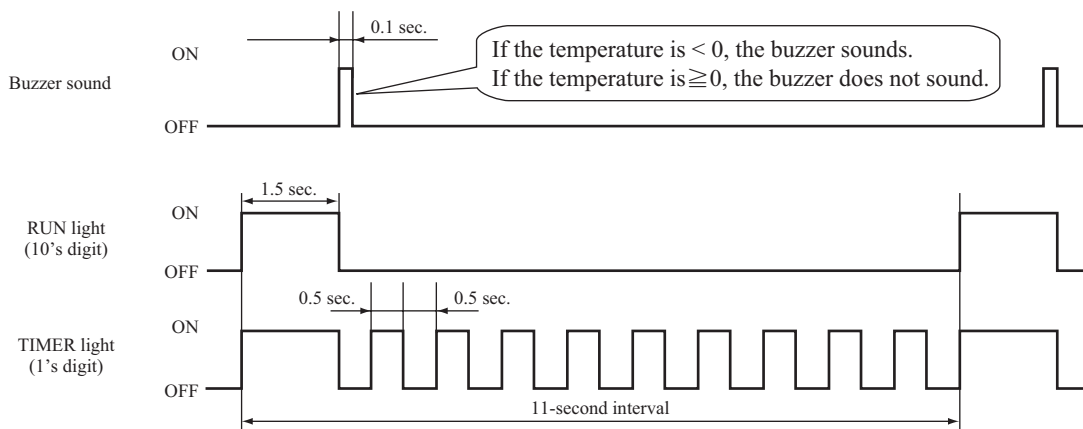

(ii) Discharge pipe sensor temperature

Units: °C

Buzzer sound	RUN light (10's digit)	TIMER light (1's digit)										
		0	1	2	3	4	5	6	7	8	9	
Yes (sounds for 0.1 second)	3	-60	-62	-64								
	2	-40	-42	-44	-46	-48	-50	-52	-54	-56	-58	
	1	-20	-22	-24	-26	-28	-30	-32	-34	-36	-38	
	0	/	-2	-4	-6	-8	-10	-12	-14	-16	-18	
No (does not sound)	0	0	2	4	6	8	10	12	14	16	18	
	1	20	22	24	26	28	30	32	34	36	38	
	2	40	42	44	46	48	50	52	54	56	58	
	3	60	62	64	66	68	70	72	74	76	78	
	4	80	82	84	86	88	90	92	94	96	98	
	5	100	102	104	106	108	110	112	114	116	118	
	6	120	122	124	126	128	130	132	134	136	138	
	7	140	142	144	146	148	150					

\* If no data are recorded (error code is normal), the display for each temperature information becomes as shown below.

Sensor name	Sensor value displayed when the error code is normal
Discharge pipe sensor	-64°C

(Example) Discharge pipe temperature data: "122°C"

\* In the case of discharge pipe data, multiply the reading value by 2. (Below, 61 x 2 = "122°C")

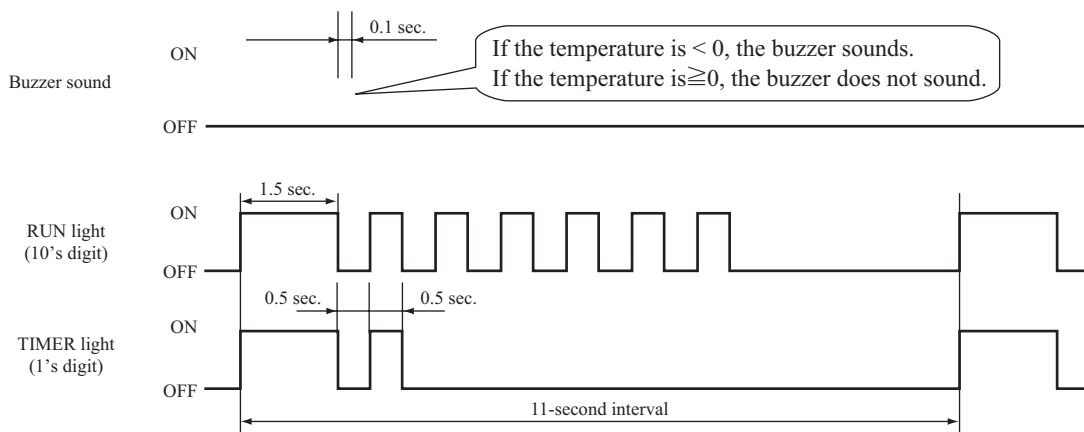

## Service data record form

Customer		Model					
Date of investigation							
Machine name							
Content of complaint							
Wireless remote control settings			Content of displayed data	Display results			Display content
Temperature setting	Operation mode	Fan speed mode		Buzzer (Yes/No.)	RUN light (Times)	TIMER light (Times)	
21	Cooling	MED	Error code on previous occasion.	/			
		HI	Room temperature sensor on previous occasion.				
		AUTO	Indoor heat exchanger sensor 1 on previous occasion.				
	Heating	LO	Wireless remote control information on previous occasion.	/			
		MED	Outdoor air temperature sensor on previous occasion.				
		HI	Outdoor heat exchanger sensor on previous occasion.				
	AUTO	Discharge pipe sensor on previous occasion.					
26	Cooling	AUTO	Indoor heat exchanger sensor 2 on previous occasion.				
22	Cooling	MED	Error code on second previous occasion.	/			
		HI	Room temperature sensor on second previous occasion.				
		AUTO	Indoor heat exchanger sensor 1 on second previous occasion.				
	Heating	LO	Wireless remote control information on second previous occasion.	/			
		MED	Outdoor air temperature sensor on second previous occasion.				
		HI	Outdoor heat exchanger sensor on second previous occasion.				
	AUTO	Discharge pipe sensor on second previous occasion.					
27	Cooling	AUTO	Indoor heat exchanger sensor 2 on second occasion.				
23	Cooling	MED	Error code on third previous occasion.	/			
		HI	Room temperature sensor on third previous occasion.				
		AUTO	Indoor heat exchanger sensor 1 on third previous occasion.				
	Heating	LO	Wireless remote control information on third previous occasion.	/			
		MED	Outdoor air temperature sensor on third previous occasion.				
		HI	Outdoor heat exchanger sensor on third previous occasion.				
	AUTO	Discharge pipe sensor on third previous occasion.					
28	Cooling	AUTO	Indoor heat exchanger sensor 2 on third occasion.				
24	Cooling	MED	Error code on fourth previous occasion.	/			
		HI	Room temperature sensor on fourth previous occasion.				
		AUTO	Indoor heat exchanger sensor 1 on fourth previous occasion.				
	Heating	LO	Wireless remote control information on fourth previous occasion.	/			
		MED	Outdoor air temperature sensor on fourth previous occasion.				
		HI	Outdoor heat exchanger sensor on fourth previous occasion.				
	AUTO	Discharge pipe sensor on fourth previous occasion.					
29	Cooling	AUTO	Indoor heat exchanger sensor 2 on fourth occasion.				
25	Cooling	MED	Error code on fifth previous occasion.	/			
		HI	Room temperature sensor on fifth previous occasion.				
		AUTO	Indoor heat exchanger sensor 1 on fifth previous occasion.				
	Heating	LO	Wireless remote control information on fifth previous occasion.	/			
		MED	Outdoor air temperature sensor on fifth previous occasion.				
		HI	Outdoor heat exchanger sensor on fifth previous occasion.				
	AUTO	Discharge pipe sensor on fifth previous occasion.					
30	Cooling	AUTO	Indoor heat exchanger sensor 2 on fifth occasion.				
21	Cooling	LO	Stop code on previous occasion.				
22			Stop code on second previous occasion.				
23			Stop code on third previous occasion.				
24			Stop code on fourth previous occasion.				
25			Stop code on fifth previous occasion.				
26			Stop code on sixth previous occasion.				
27			Stop code on seventh previous occasion.				
28			Stop code on eighth previous occasion.				
29			Stop code on ninth previous occasion.				
30			Stop code on tenth previous occasion.				
Judgment							Examiner
Remarks							

Note (1) In the case of indoor heat exchanger sensor 2, match from 26 to 30 the temperature setting of wireless remote control. (Refer to page 58)

(7) Inspection procedures corresponding to detail of trouble

**Sensor error**

[ Broken sensor wire, connector poor connection ]

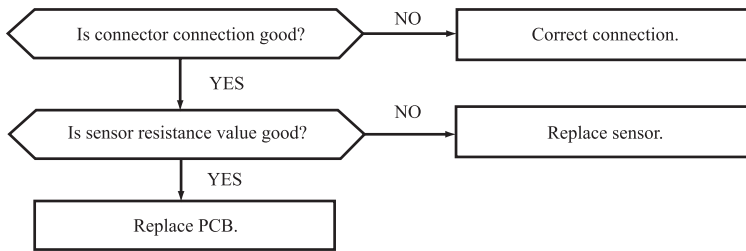

◆ Discharge pipe sensor temperature characteristics

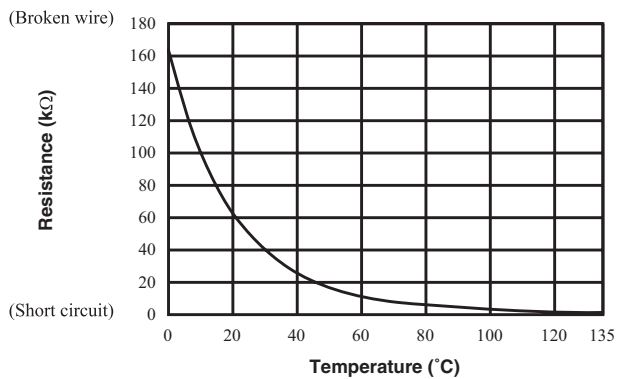

◆ Sensor temperature characteristics (Room temp., indoor heat exchanger temp., outdoor heat exchanger temp., outdoor air temp.)

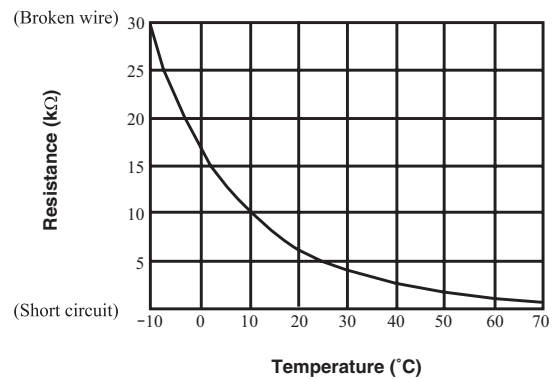

**Indoor fan motor error**

[ Defective fan motor, connector poor connection, defective indoor PCB ]

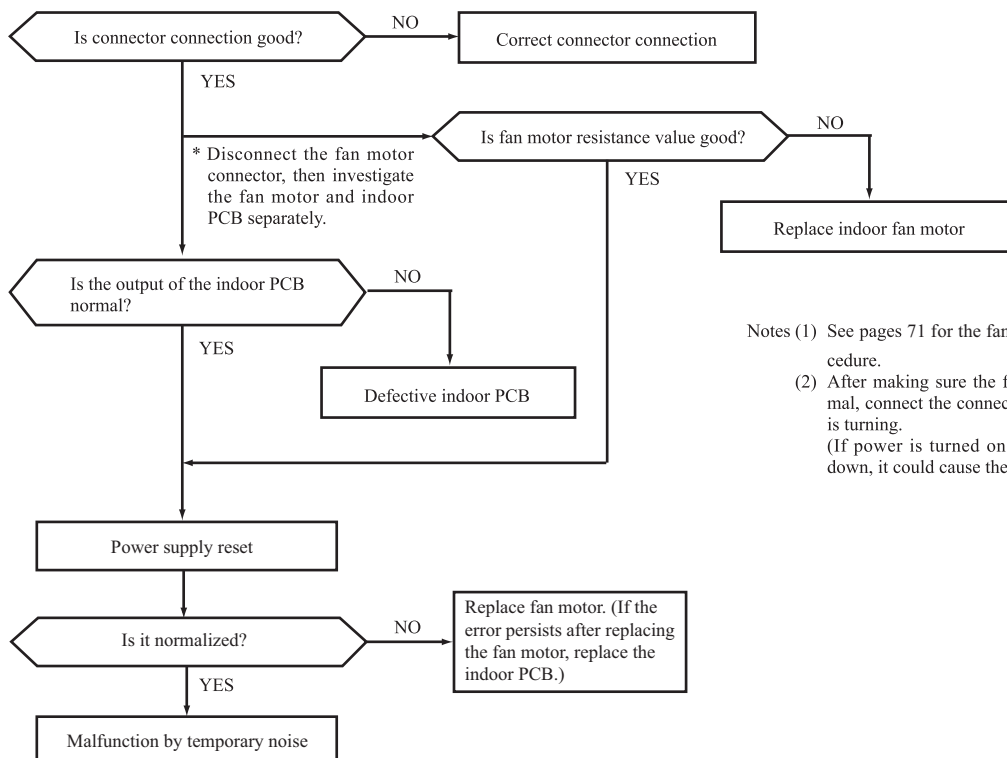

Notes (1) See pages 71 for the fan motor and indoor PCB check procedure.

(2) After making sure the fan motor and indoor PCB are normal, connect the connectors and confirm that the fan motor is turning. (If power is turned on while one or the other is broken down, it could cause the other to break down also.)



## Current cut

[Compressor lock, Compressor wiring short circuit, Compressor output is open phase, Outdoor PCB is faulty, Service valve is closed, EEV is faulty, Compressor faulty.]

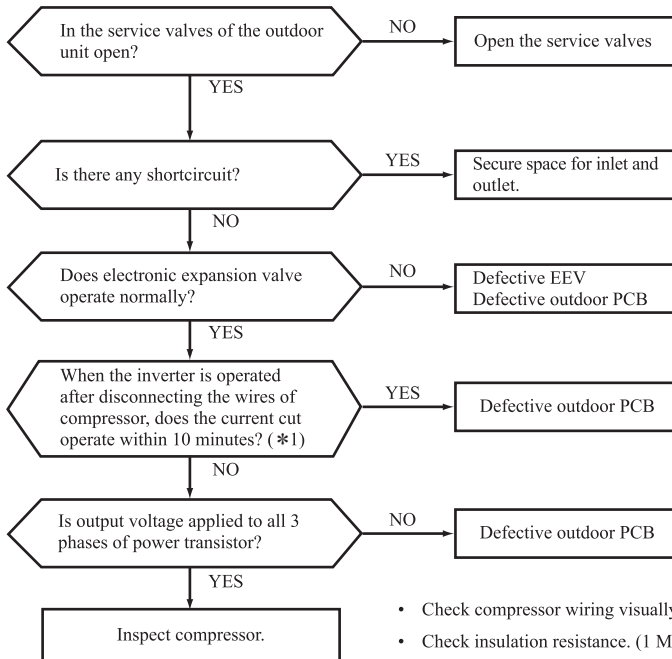

For inspection of electronic expansion valve, see page 75

\*1 If it is normal, it is the rotor lock problem.

- Check compressor wiring visually.
  - Check insulation resistance. (1 MΩ or over)
  - Check coil wire resistance.
- If check results are normal, compressor is locked.

SRC20-35:1.703Ω (U-V, V-W, U-W) or more at 20°C

SRC50:1.417Ω (U-V), 1.392Ω (V-W), 1.435Ω (W-U) or more at 20°C

## Current safe stop

[Overload operation, compressor lock, overcharge]

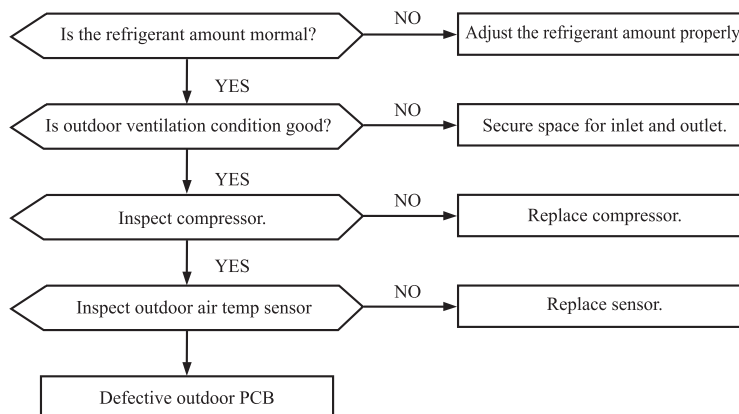

## Over heat of compressor

[ Gas shortage, defective discharge pipe sensor ]

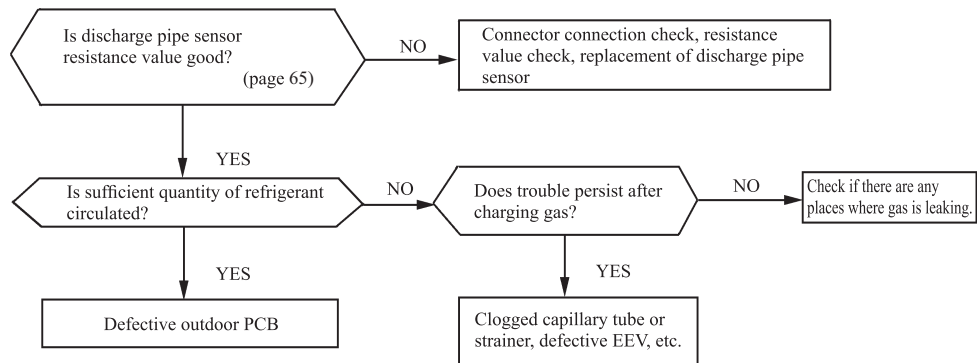

## Error of signal transmission

[ Wiring error including power cable, defective indoor/ outdoor PCB ]

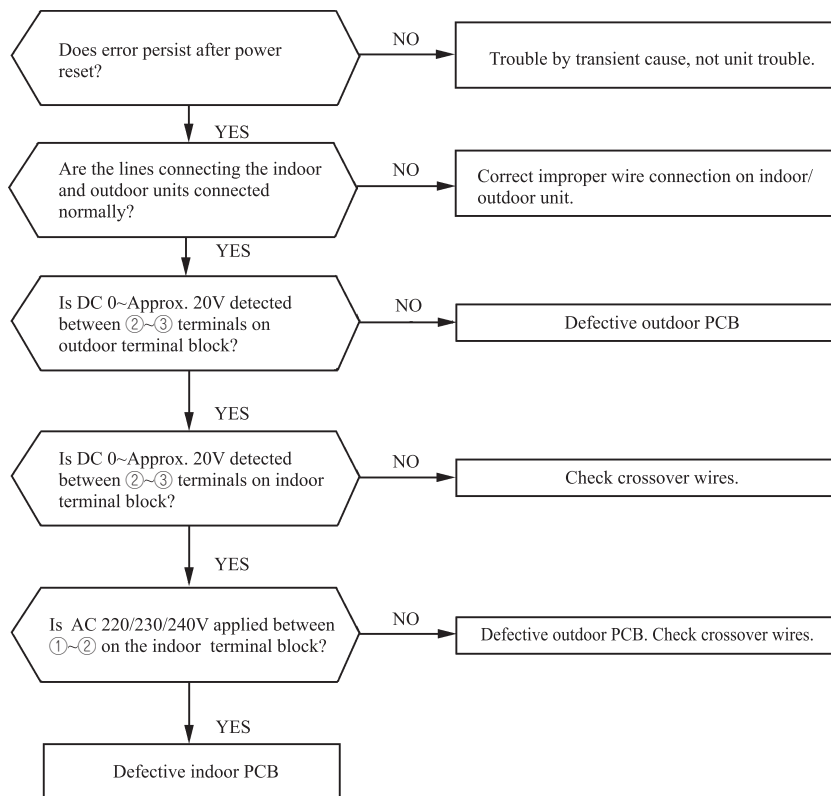

### Trouble of outdoor unit

[ Insufficient refrigerant amount, Faulty power transistor, Broken compressor wire ]  
 [ Service valve close, Defective EEV, Defective outdoor PCB ]

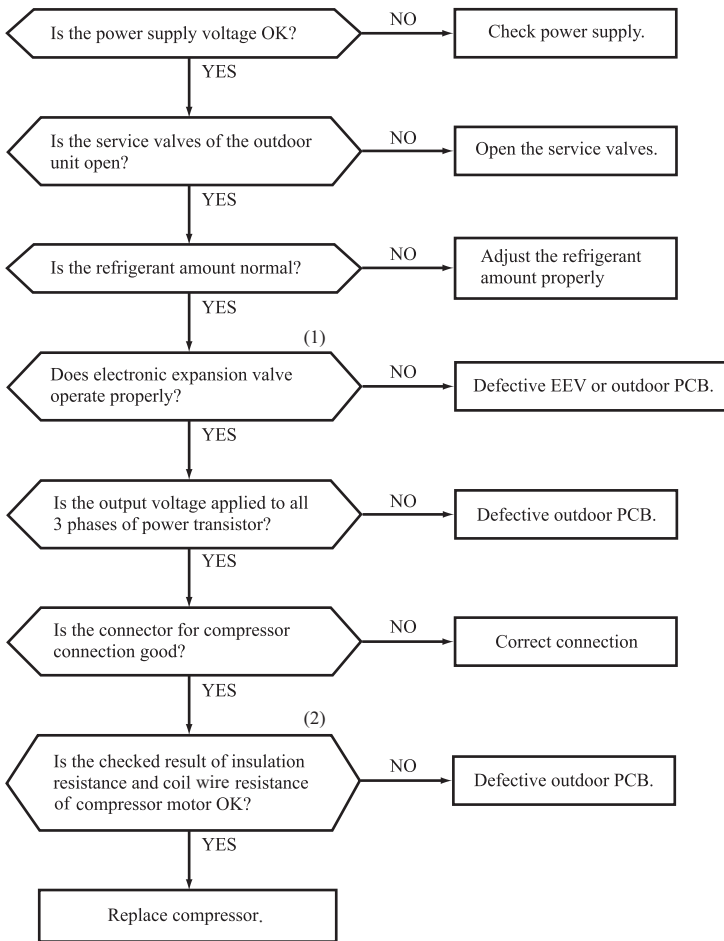

Proper power supply voltages are as follows.  
 (At the power supply outlet)  
 AC 220V : AC 198~242V  
 AC 230V : AC 207~253V  
 AC 240V : AC 216~264V

- ◆ Judgment of refrigerant quantity
- (1) Phenomenon of insufficient refrigerant
    - (a) Loss of capacity
    - (b) Poor defrosting  
(Frost is not removed completely.)
    - (c) Longer time of hot keep  
(5 minute or more)  
(Normal time: Approx. 1 – 1 minute and 30 seconds)

Notes (1) For inspection of electronic expansion valve, see page 75

(2) Check coil wire resistance, see page 66.

### Outdoor fan motor error

[ Defective fan motor, connector poor connection, defective outdoor PCB ]

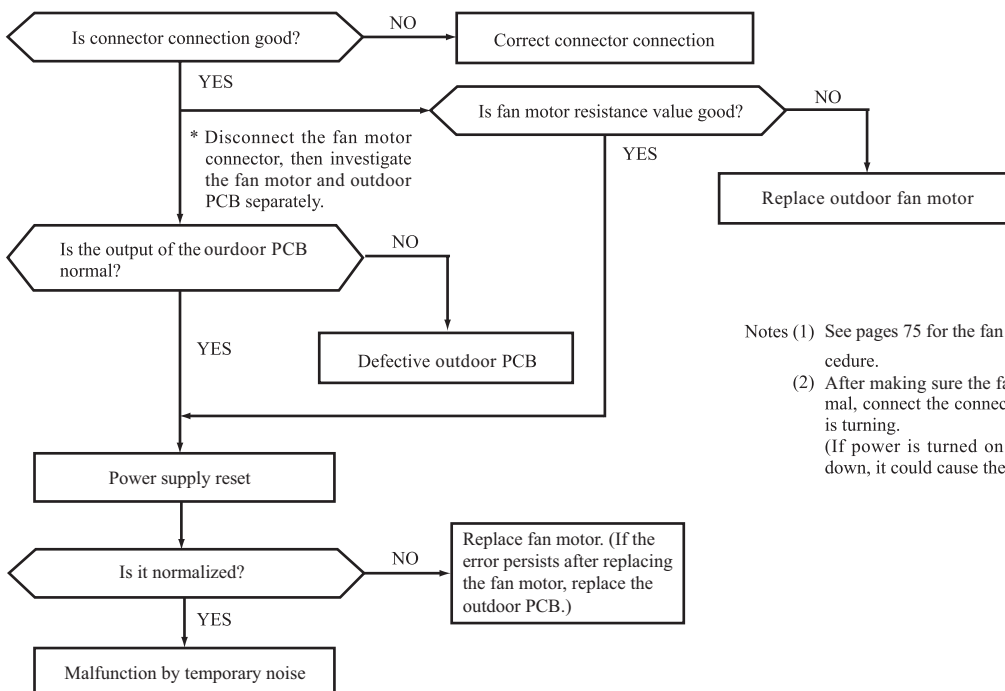

Notes (1) See pages 75 for the fan motor and outdoor PCB check procedure.

(2) After making sure the fan motor and outdoor PCB are normal, connect the connectors and confirm that the fan motor is turning.  
 (If power is turned on while one or the other is broken down, it could cause the other to break down also.)

## Rotor lock

[ Defective compressor, defective outdoor PCB ]

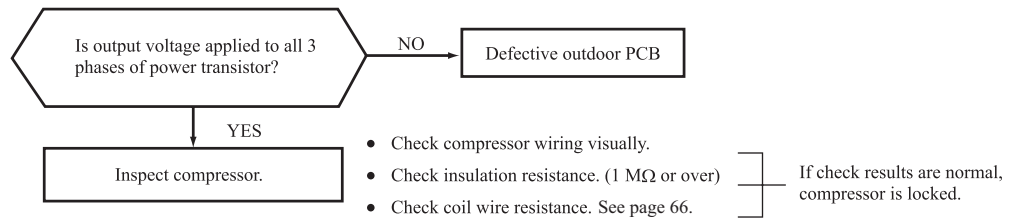

## Service valve (gas side) closed operation

[ Service valve (gas side) closed, Defective outdoor PCB ]

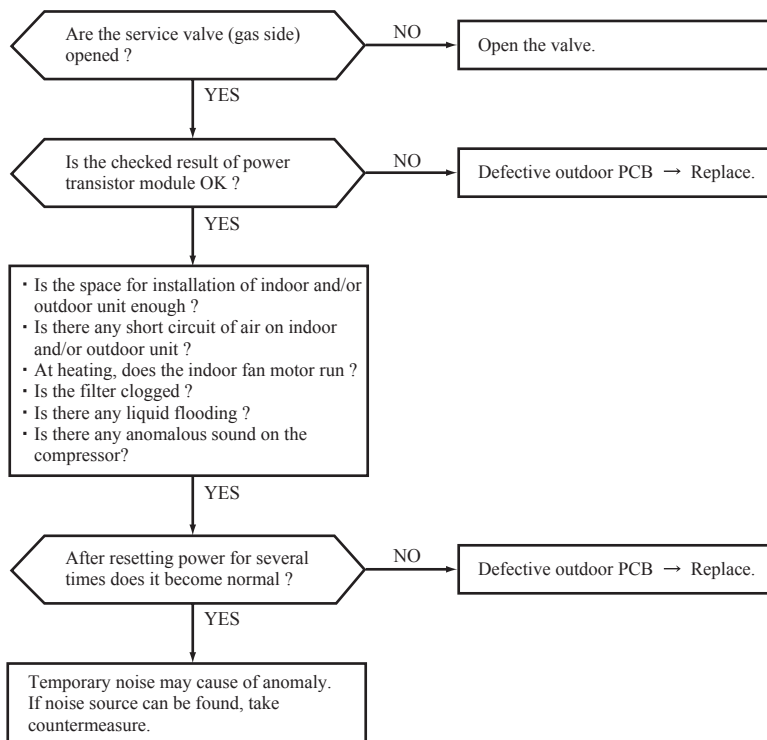

**(8) Phenomenon observed after shortcircuit, wire breakage on sensor**

**(a) Indoor unit**

Sensor	Operation mode	Phenomenon	
		Shortcircuit	Disconnected wire
Room temperature sensor	Cooling	Release of continuous compressor operation command.	Continuous compressor operation command is not released.
	Heating	Continuous compressor operation command is not released.	Release of continuous compressor operation command.
Heat exchanger sensor	Cooling	Freezing cycle system protection trips and stops the compressor.	Continuous compressor operation command is not released. (Anti-frosting)
	Heating	High pressure control mode (Compressor stop command)	Hot keep (Indoor fan stop)
Humidity sensor <sup>(1)</sup>	Cooling	Refer to the table below.	Refer to the table below.
	Heating	Normal system operation is possible.	

Note (1) SRK35, 50 only.

**■ Humidity sensor operation**

Failure mode	Control input circuit reading	Air conditioning system operation
Disconnected wire	① Disconnected wire	Humidity reading is 0%
	② Disconnected wire	
	①② Disconnected wire	
Short circuit	① and ② are short circuited	Humidity reading is 100%

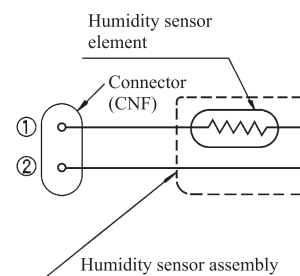

Remark: Do not perform a continuity check of the humidity sensor with a tester. If DC current is applied, it could damage the sensor.

**(b) Outdoor unit**

Sensor	Operation mode	Phenomenon	
		Shortcircuit	Disconnected wire
Heat exchanger sensor	Cooling	Compressor stop.	Compressor stop.
	Heating	Defrosting is not performed.	Defrosting is performed for 10 minutes at approx. 35 minutes.
Outdoor air temperature sensor	Cooling	The compressor cannot pick up its speed owing to the current safe so that the designed capacity is not achieved.	Compressor stop.
	Heating	The compressor cannot pick up its speed owing to the heating overload protection so that the designed capacity is not achieved.	Defrosting is performed for 10 minutes at approx. 35 minutes.
Discharge pipe sensor	All modes	Compressor overload protection is disabled. (Can be operated.)	Compressor stop.

**(9) Checking the indoor electrical equipment**

**(a) Indoor PCB check procedure**

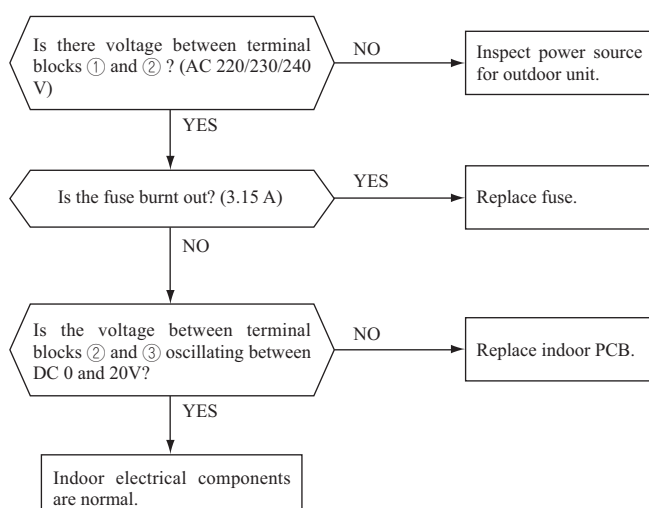

**(b) Indoor unit fan motor check procedure**

This is a diagnostic procedure for determining if the indoor unit's fan motor or the indoor PCB is broken down.

**1) Indoor PCB output check**

- a) Turn off the power.
- b) Remove the front panel, then disconnect the fan motor lead wire connector.
- c) Turn on the power. If the unit operates when the ON/OFF button is pressed, if trouble is detected after the voltages in the following figure are output for approximately 30 seconds, it means that the indoor PCB is normal and the fan motor is broken down.

If the voltages in the following figure are not output at connector pins No. ①, ④ and ⑤, the indoor PCB has failed and the fan motor is normal.

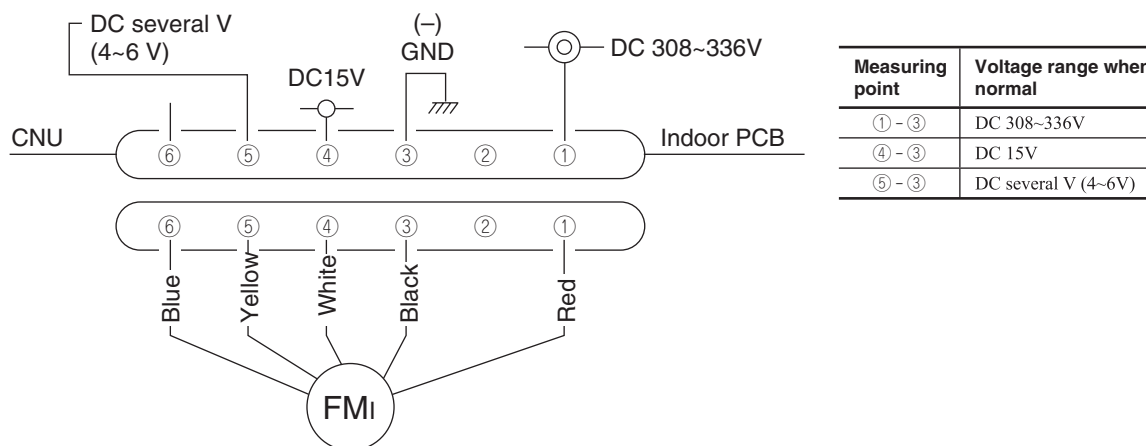

**2) Fan motor resistance check**

Measuring point	Resistance when normal
① - ③ (Red - Black)	20 MΩ or higher
④ - ③ (White - Black)	20 kΩ or higher

- Notes (1) Remove the fan motor and measure it without power connected to it.  
 (2) If the measured value is below the value when the motor is normal, it means that the fan motor is faulty.

**(10) How to make sure of wireless remote control**

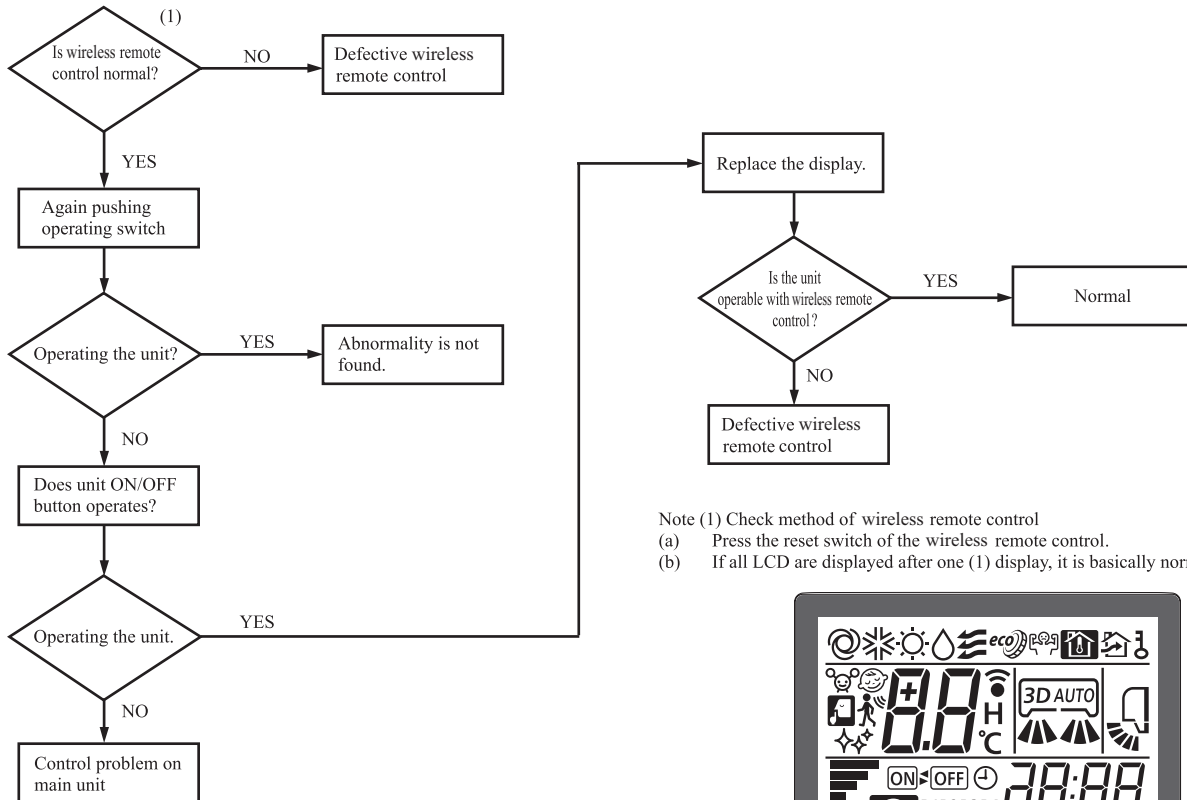

Note (1) Check method of wireless remote control  
 (a) Press the reset switch of the wireless remote control.  
 (b) If all LCD are displayed after one (1) display, it is basically normal.

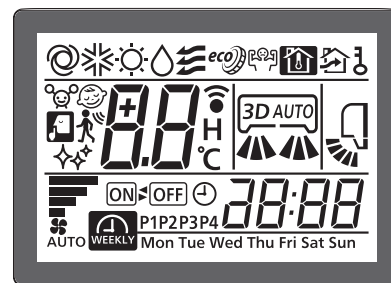

◆ Simplified check method of wireless remote control  
 It is normal if the signal transmission section of the wireless remote control emits a whitish light at each transmission on the monitor of digital camera.

**(11) Inspection procedure for blown fuse on the indoor and outdoor PCB**

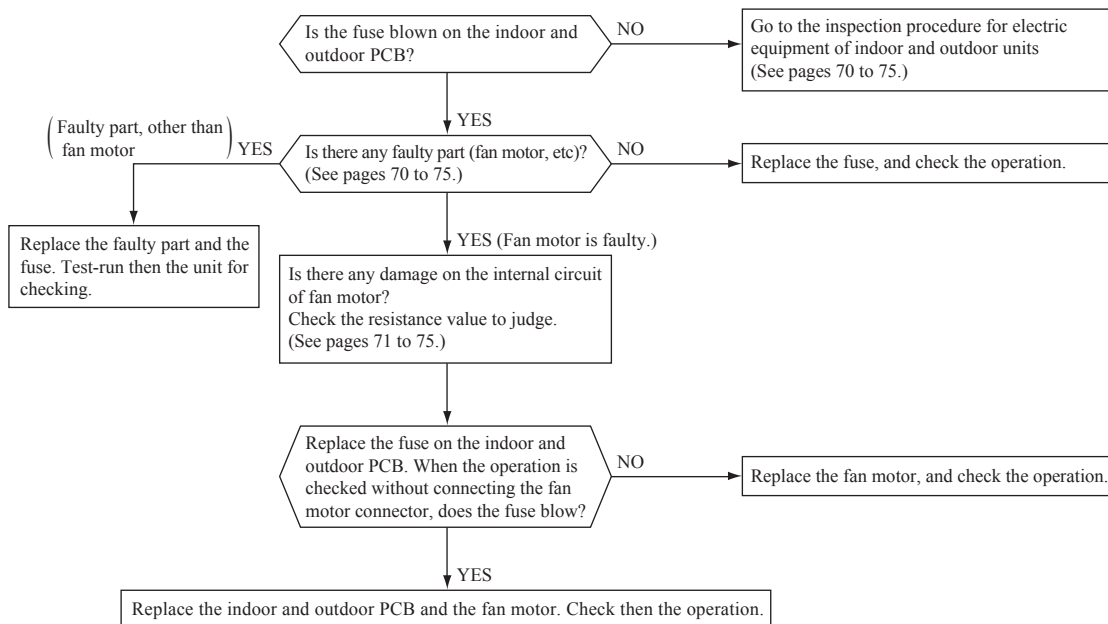

(12) Outdoor unit inspection points

Models SRC20ZM-S, 25ZM-S, 35ZM-S

◆ Check point of outdoor unit

**⚠ CAUTION – HIGH VOLTAGE**  
 High voltage is produced in the control box. Don't touch electrical parts in the control box for 5 minutes after the unit is stopped.

**◆ Power source and serial signal inspection**  
 ① to ③ : AC 220/230/240V  
 ① to ②/N : AC 220/230/240V  
 ②/N to ③ : Normal if the voltage oscillates between DC 0 and approx. 20V

**Color symbol**

Mark	Color
BK	Black
BL	Blue
BR	Brown
OR	Orange
RD	Red
WH	White
Y/G	Yellow/Green

**◆ Voltage check in PCB**  
 The normal range is as follows.

Display	Voltage range
① DC280V	DC230V - DC310V
② DC 20V	DC 18V - DC 22V
③ DC 13V	DC 12V - DC 14V
④ DC 15V	DC 14V - DC 16V
⑤ DC 5V	DC 4V - DC 6V
⑥ DC 2.5V	DC 2.3V - DC 2.5V

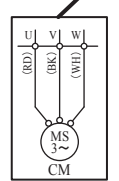
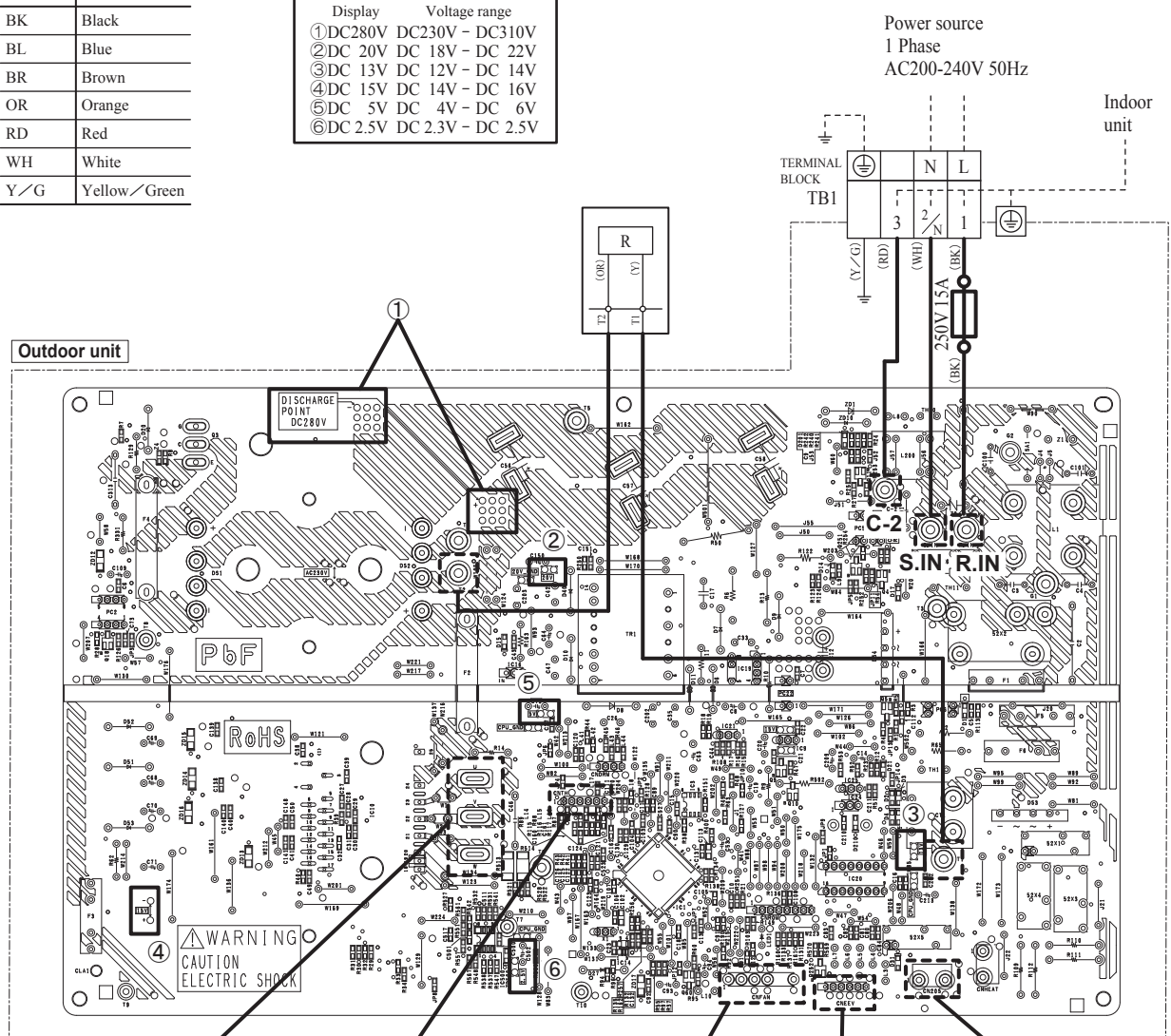

**◆ Inspection power transistor**  
 Remove the fasten terminal and test output voltage

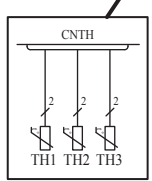

**◆ Inspection of resistance valve of sensor**  
 Remove the connector and check the resistance valve. See the section of sensor characteristics on page 65 .

**◆ Inspection of outdoor fan motor**  
 See page 75 .

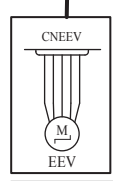
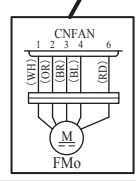

**◆ Inspection of electronic expansion valve**  
 See page 75 .

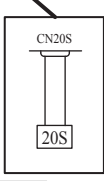



Model SRC50ZM-S

◆ Check point of outdoor unit

**⚠ CAUTION – HIGH VOLTAGE**  
 High voltage is produced in the control box. Don't touch electrical parts in the control box for 5 minutes after the unit is stopped.

**◆ Power source and serial signal inspection**  
 ① to ⑥ : AC 220/230/240V  
 ① to ②/N : AC 220/230/240V  
 ②/N to ③ : Normal if the voltage oscillates between DC 0 and approx. 20V

**Color symbol**

Mark	Color
BK	Black
BL	Blue
BR	Brown
OR	Orange
RD	Red
WH	White
Y/G	Yellow/Green

**◆ Voltage check in PCB**  
 The normal range is as follows.  
 Display Voltage range  
 ① DC280V DC230V - DC310V  
 ② DC 20V DC 18V - DC 22V  
 ③ DC 13V DC 12V - DC 14V  
 ④ DC 15V DC 14V - DC 16V  
 ⑤ DC 5V DC 4V - DC 6V  
 ⑥ DC 2.5V DC 2.3V - DC 2.5V

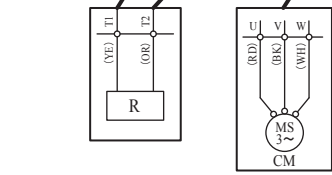
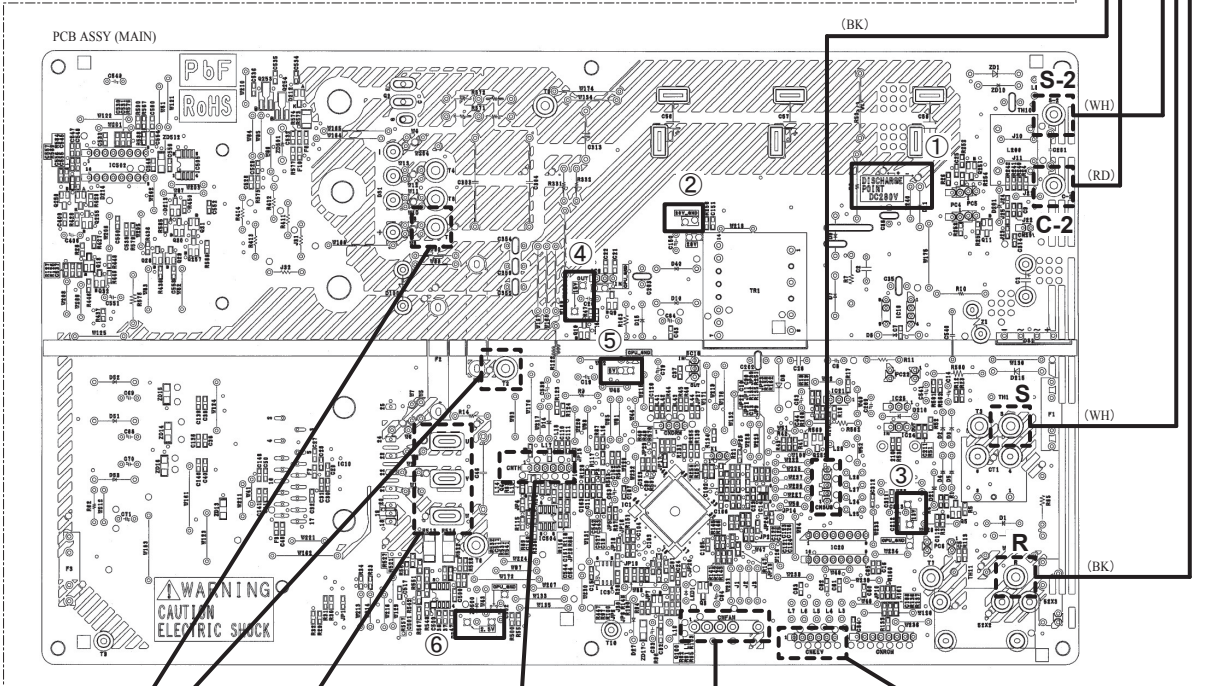
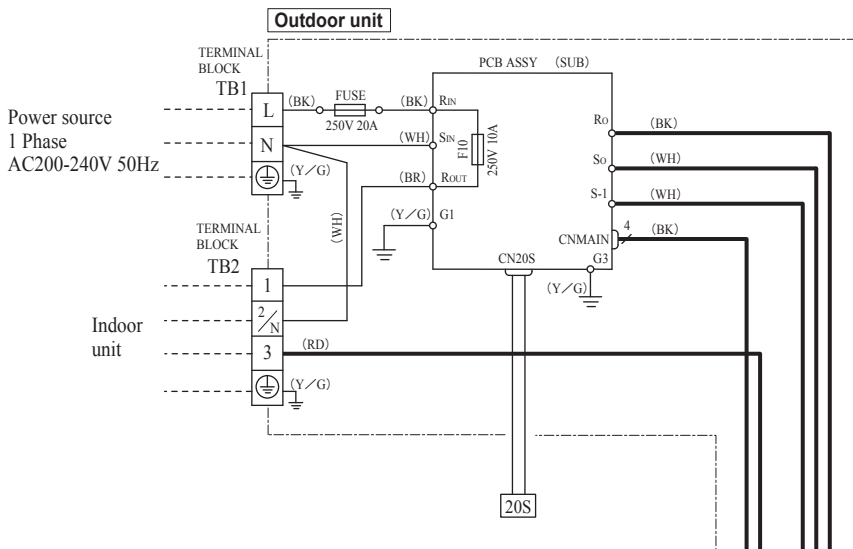

**◆ Inspection power transistor**  
 Remove the fasten terminal and test output voltage

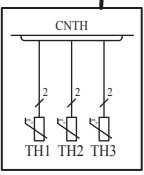
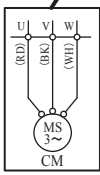

**◆ Inspection of resistance valve of sensor**  
 Remove the connector and check the resistance valve. See the section of sensor characteristics on page 65 .

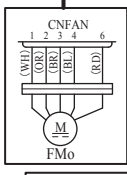

**◆ Inspection of outdoor fan motor**  
 See page 75 .

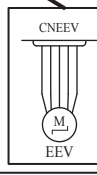

**◆ Inspection of electronic expansion valve**  
 See page 75 .

**(a) Inspection of electronic expansion valve**

Electronic expansion valve operates for approx. 10 seconds after the power on, in order to determine its aperture. Check the operating sound and voltage during the period of time. (Voltage cannot be checked during operation in which only the aperture change occurs.)

- (i) If it is heard the sound of operating electronic expansion valve, it is almost normal.
- (ii) If the operating sound is not heard, check the output voltage.

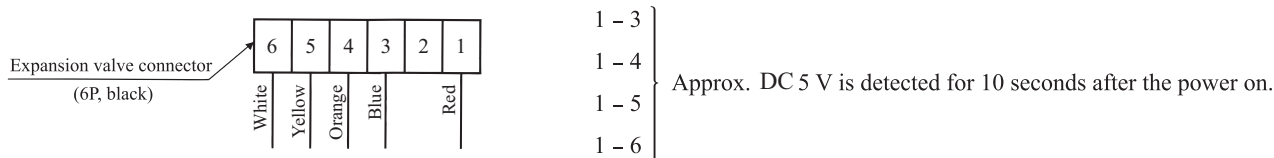

- (iii) If voltage is detected, the outdoor PCB is normal.
- (iv) If the expansion valve does not operate (no operating sound) while voltage is detected, the expansion valve is defective.

**• Inspection of electronic expansion valve as a separate unit**

Measure the resistance between terminals with an analog tester.

Measuring point	Resistance when normal
1-6	46 ± 4Ω (at 20°C)
1-5	
1-4	
1-3	

**(b) Outdoor unit fan motor check procedure**

- When the outdoor unit fan motor error is detected, diagnose which of the outdoor unit fan motor or outdoor PCB is defective.
- Diagnose this only after confirming that the indoor unit is normal.

**(i) Outdoor PCB output check**

- 1) Turn off the power.
- 2) Disconnect the outdoor unit fan motor connector CNFAN.
- 3) When the indoor unit is operated by inserting the power supply plug and pressing (ON) the backup switch for more than 5 seconds, if the voltage of pin No. ② in the following figure is output for 30 seconds at 20 seconds after turning “ON” the backup switch, the outdoor PCB is normal but the fan motor is defective.

If the voltage is not detected, the outdoor PCB is defective but the fan motor is normal.

Note (1) The voltage is output 3 times repeatedly. If it is not detected, the indoor unit displays the error message.

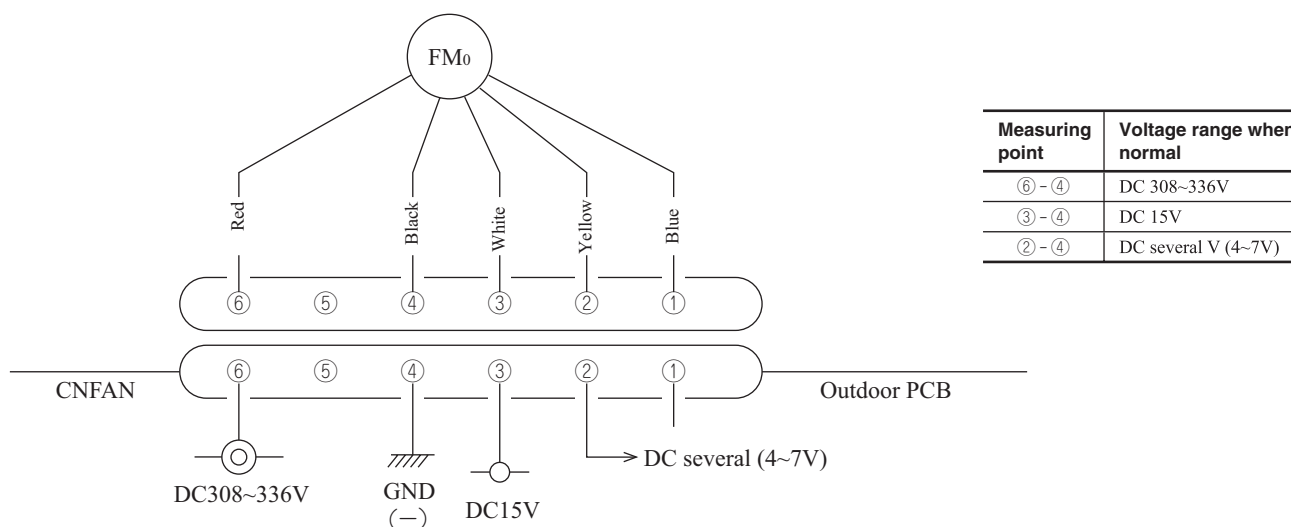

**(ii) Fan motor resistance check**

Measuring point	Resistance when normal
⑥ - ④ (Red - Blue)	20 MΩ or higher
③ - ④ (White - Blue)	20 kΩ or higher

- Notes (1) Remove the fan motor and measure it without power connected to it.
- (2) If the measured value is below the value when the motor is normal, it means that the fan motor is faulty.



# 11. OPTION PARTS

PJA012D730

## (1) Wired remote control (RC-E5)

Read together with indoor unit's installation manual.



### ⚠ WARNING

- Fasten the wiring to the terminal securely and hold the cable securely so as not to apply unexpected stress on the terminal.  
Loose connection or hold will cause abnormal heat generation or fire. 
- Make sure the power supply is turned off when electric wiring work.  
Otherwise, electric shock, malfunction and improper running may occur. 

### ⚠ CAUTION

- DO NOT install the remote control at the following places in order to avoid malfunction.
 

(1) Places exposed to direct sunlight	(4) Hot surface or cold surface enough to generate condensation
(2) Places near heat devices	(5) Places exposed to oil mist or steam directly
(3) High humidity places	(6) Uneven surface

- DO NOT leave the remote control without the upper case.  
In case the upper case needs to be detached, protect the remote control with a packaging box or bag in order to keep it away from water and dust. 

Accessories	Remote control, wood screw (ø3.5×16) 2 pieces
Prepare on site	Remote control cord (2 cores) the insulation thickness in 1mm or more. [In case of embedding cord] Electrical box, M4 screw (2 pieces) [In case of exposing cord] Cord clamp (if needed)

### Installation procedure

- ① Open the cover of remote control, and remove the screw under the buttons without fail.
- ② Remove the upper case of remote control.  
Insert a flat-blade screwdriver into the dented part of the upper part of the remote control, and wrench slightly.

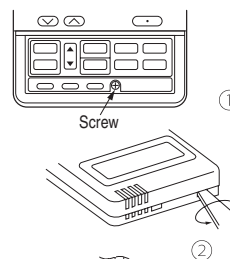

### [In case of embedding cord]

- ③ Embed the electrical box and remote control cord beforehand.

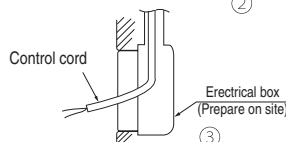

- ④ Prepare two M4 screws (recommended length is 12-16mm) on site, and install the lower case to electrical box. Choose either of the following two positions in fixing it with screws.

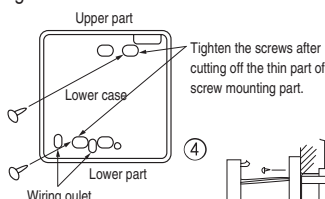
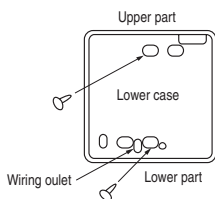

- ⑤ Connect the remote control cord to the terminal block.  
Connect the terminal of remote control (X,Y) with the terminal of indoor unit (X,Y). (X and Y are no polarity)
- ⑥ Install the upper case as before so as not to catch up the remote control cord, and tighten with the screws.

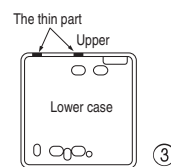
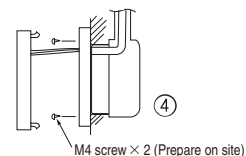

### [In case of exposing cord]

- ③ You can pull out the remote control cord from left upper part or center upper part.  
Cut off the upper thin part of remote control lower case with a nipper or knife, and grind burrs with a file etc.
- ④ Install the lower case to the flat wall with attached two wooden screws.

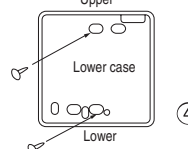

- ⑤ Connect the remote control cord to the terminal block.  
Connect the terminal of remote control (X,Y) with the terminal of indoor unit (X,Y).  
(X and Y are no polarity)  
Wiring route is as shown in the right diagram depending on the pulling out direction.

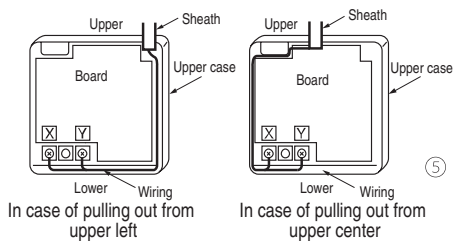

The wiring inside the remote control case should be within 0.3mm<sup>2</sup> (recommended) to 0.5mm<sup>2</sup>.  
The sheath should be peeled off inside the remote control case.  
The peeling-off length of each wire is as below.

Pulling out from upper left	Pulling out from upper center
X wiring : 215mm	X wiring : 170mm
Y wiring : 195mm	Y wiring : 190mm

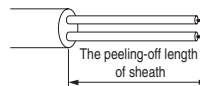

- ⑥ Install the upper case as before so as not to catch up the remote control cord, and tighten with the screws.
- ⑦ In case of exposing cord, fix the cord on the wall with cord clamp so as not to slack.

**Installation and wiring of remote control**

- ① Wiring of remote control should use 0.3mm<sup>2</sup> × 2 core wires or cables. (on-site configuration)
- ② Maximum prolongation of remote control wiring is 600 m.  
If the prolongation is over 100m, change to the size below.  
But, wiring in the remote control case should be under 0.5mm<sup>2</sup>. Change the wire size outside of the case according to wire connecting. Waterproof treatment is necessary at the wire connecting section. Be careful about contact failure.  
100 - 200m.....0.5mm<sup>2</sup> × 2 cores  
Under 300m.....0.75mm<sup>2</sup> × 2 cores  
Under 400m.....1.25mm<sup>2</sup> × 2 cores  
Under 600m.....2.0mm<sup>2</sup> × 2 cores

**Master/ slave setting when more than one remote controls are used**

A maximum of two remote controls can be connected to one indoor unit (or one group of indoor units.)

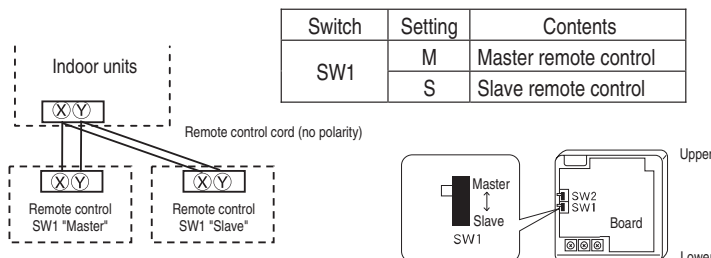

Set SW1 to "Slave" for the slave remote control. It was factory set to "Master" for shipment.  
Note: The setting "Remote control thermistor enabled" is only selectable with the master remote control in the position where you want to check room temperature.  
The air conditioner operation follows the last operation of the remote control regardless of the master/ slave setting of it.

**The indication when power source is supplied**

When power source is turned on, the following is displayed on the remote control until the communication between the remote control and indoor unit settled.

Master remote control : " WAIT " M  
Slave remote control : " WAIT " S

At the same time, a mark or a number will be displayed for two seconds first.  
This is the software's administration number of the remote control, not an error cord.

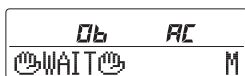

※ The left mark is only an example. Other marks may appear.

When remote control cannot communicate with the indoor unit for half an hour, the below indication will appear.  
Check wiring of the indoor unit and the outdoor unit etc.

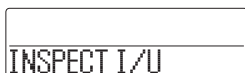

**The range of temperature setting**

When shipped, the range of set temperature differs depending on the operation mode as below.

Heating : 16-30°C (55-86°F)

Except heating (cooling, fan, dry, automatic) : 18-30°C (62-86°F)

● **Upper limit and lower limit of set temperature can be changed with remote control.**

Upper limit setting: valid during heating operation. Possible to set in the range of 20 to 30°C (68 to 86°F).

Lower limit setting: valid except heating (automatic, cooling, fan, dry) Possible to set in the range of 18 to 26°C (62 to 79°F).

When you set upper and lower limit by this function, control as below.

1. When ② TEMP RANGE SET, remote control function of function setting mode is "INDN CHANGE" (factory setting),  
 【 If upper limit value is set 】  
 During heating, you cannot set the value exceeding the upper limit.

【 If lower limit value is set 】

During operation mode except heating, you cannot set the value below the lower limit.

2. When ② TEMP RANGE SET, remote control function of function setting mode is "NO INDN CHANGE"

【 If upper limit value is set 】

During heating, even if the value exceeding the upper limit is set, upper limit value will be sent to the indoor unit.  
 But, the indication is the same as the temperature set.

【 If lower limit value is set 】

During except heating, even if the value lower than the lower limit is set, lower limit value will be sent to the indoor unit.  
 But, the indication is the same as the temperature set.

● **How to set upper and lower limit value**

1. Stop the air-conditioner, and press (SET) and (MODE) button at the same time for over three seconds .  
 The indication changes to "FUNCTION SET ▼".
2. Press button once, and change to the "TEMP RANGE ▲" indication.
3. Press (SET) button, and enter the temperature range setting mode.
4. Select "UPPER LIMIT ▼" or "LOWER LIMIT ▲" by using button.
5. Press (SET) button to fix.
6. When "UPPER LIMIT ▼" is selected (valid during heating)
  - ① Indication: " ▼ ^ SET UP" → "UPPER 30°C ▼"
  - ② Select the upper limit value with temperature setting button . Indication example: "UPPER 26°C ▼ ^" (blinking)
  - ③ Press (SET) button to fix. Indication example: "UPPER 26°C" (Displayed for two seconds)  
 After the fixed upper limit value displayed for two seconds, the indication will return to "UPPER LIMIT ▼".
7. When "LOWER LIMIT ▲" is selected (valid during cooling, dry, fan, automatic)
  - ① Indication: " ▼ ^ SET UP" → "LOWER 18°C ^"
  - ② Select the lower limit value with temperature setting button . Indication example: "LOWER 24°C ▼ ^" (blinking)
  - ③ Press (SET) button to fix. Indication for example: "LOWER 24°C" (Displayed for two seconds)  
 After the fixed lower limit value displayed for two seconds, the indication will return to "LOWER LIMIT ▼".
8. Press button to finish.

• It is possible to finish by pressing button on the way, but unfinished change of setting is unavailable.

• During setting, if you press (RESET) button, you return to the previous screen.

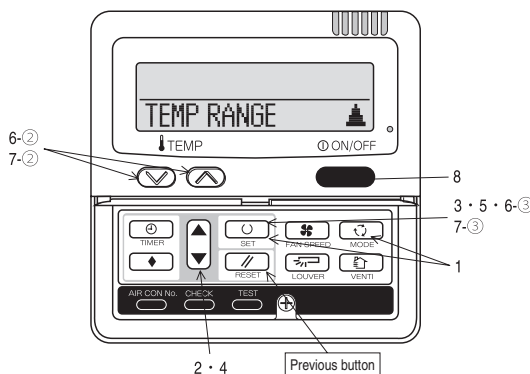

**The functional setting**

● The initial function setting for typical using is performed automatically by the indoor unit connected, when remote control and indoor unit are connected.  
 As long as they are used in a typical manner, there will be no need to change the initial settings.  
 If you would like to change the initial setting marked "○", set your desired setting as for the selected item.  
 The procedure of functional setting is shown as the following diagram.

**[Flow of function setting]**

Start : Stop air-conditioner and press "○" (SET) and "◀▶" (MODE) buttons at the same time for over three seconds.  
 Finalize : Press "○" (SET) button.  
 Reset : Press "↺" (RESET) button.  
 Select : Press "▲▼" button.  
 End : Press "ON/OFF" button.

It is possible to finish above setting on the way, and unfinished change of setting is unavailable.  
 \*○\*: Initial settings  
 \*※\*: Automatic criterion

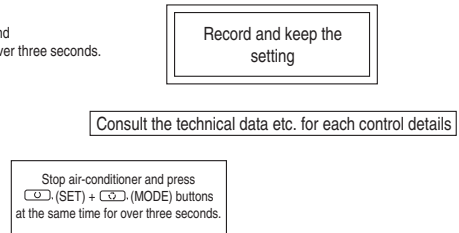

To next page

**FUNCTION (Remote control function)**

Function	setting	
01   ESP SET	ESP VALID ○ ESP INVALID ○	Validate setting of ESP: External Static Pressure Invalidate setting of ESP
02   AUTO RUN SET	AUTO RUN ON ※ AUTO RUN OFF ※	Automatic operation is impossible
03   TEMP SW	TEMP VALID ○ TEMP INVALID ○	Temperature setting button is not working
04   MODE SW	MODE VALID ○ MODE INVALID ○	Mode button is not working
05   ON/OFF SW	ON/OFF VALID ○ ON/OFF INVALID ○	On/Off button is not working
06   FAN SPEED SW	FAN SPEED VALID ○ FAN SPEED INVALID ○	Fan speed button is not working
07   LOUVER SW	LOUVER VALID ○ LOUVER INVALID ○	Louver button is not working
08   TIMER SW	TIMER VALID ○ TIMER INVALID ○	Timer button is not working
09   SENSOR SET	SENSOR OFF ○ SENSOR ON ○ SENSOR +3.0℃ ※ SENSOR +2.0℃ ※ SENSOR +1.0℃ ※ SENSOR -1.0℃ ※ SENSOR -2.0℃ ※ SENSOR -3.0℃ ※	Remote thermistor is not working. Remote thermistor is working. Remote thermistor is working, and to be set for producing +3.0°C increase in temperature. Remote thermistor is working, and to be set for producing +2.0°C increase in temperature. Remote thermistor is working, and to be set for producing +1.0°C increase in temperature. Remote thermistor is working, and to be set for producing -1.0°C increase in temperature. Remote thermistor is working, and to be set for producing -2.0°C increase in temperature. Remote thermistor is working, and to be set for producing -3.0°C increase in temperature.
10   AUTO RESTART	INVALID ○ VALID ○	
* 11   VENT LINK SET	NO VENT ○ VENT LINK ○ NO VENT LINK ○	In case of Single split series, by connecting ventilation device to CNT of the indoor printed circuit board (in case of VRF series, by connecting it to CND of the indoor printed circuit board), the operation of ventilation device is linked with the operation of indoor unit. In case of Single split series, by connecting ventilation device to CNT of the indoor printed circuit board (in case of VRF series, by connecting it to CND of the indoor printed circuit board), you can operate /stop the ventilation device independently by (VENT) button.
12   TEMP RANGE SET	INDIC CHANGE ○ NO INDIC CHANGE ○	If you change the range of set temperature, the indication of set temperature will vary following the control. If you change the range of set temperature, the indication of set temperature will not vary following the control, and keep the set temperature.
13   FAN POSITION	HI-MID-LO ※ HI-LO ※ HI-MID ※ 1 FAN SPEED ※	Airflow of fan becomes of  or the four speed of . Airflow of fan becomes of . Airflow of fan becomes of . Airflow of fan is fixed at one speed.
14   POSITION	POSITION STOP ○ FREE STOP ○	If you change the remote control function "14 POSITION" you must change the indoor function "04 POSITION" accordingly. You can select the louver stop position in the four. The louver can stop at any position.
15   MODEL TYPE	HEAT PUMP ※ COOLING ONLY ※	
16   EXTERNAL CONTROL SET	INDIVIDUAL ○ FOR ALL UNITS ○	If you input signal into CNT of the indoor printed circuit board from external, the indoor unit will be operated independently according to the input from external. If you input into CNT of the indoor printed circuit board from external, all units which connect to the same remote control are operated according to the input from external.
17   ROOM TEMP INDICATION SET	INDICATION OFF ○ INDICATION ON ○	In normal working indication, indoor unit temperature is indicated instead of airflow. (Only the master remote control can be indicated.)
18   INDICATION	INDICATION ON ○ INDICATION OFF ○	Heating preparation indication should not be indicated.
19   °C/°F SET	℃ ○ °F ○	Temperature indication is by degree C Temperature indication is by degree F

To next page

Note (1)\*The mark cannot use SRK series.

ON/OFF button (finished)



Note 1: The initial setting marked "※" is decided by connected indoor and outdoor unit, and is automatically defined as following table.

Function No.	Item	Default	Model
Remote control function02	AUTO RUN SET	AUTO RUN ON	"Auto-RUN" mode selectable indoor unit.
		AUTO RUN OFF	Indoor unit without "Auto-RUN" mode
Remote control function06	FAN SPEED SW	VALID	Indoor unit with two or three step of air flow setting
		INVALID	Indoor unit with only one of air flow setting
Remote control function07	LOUWER SW	VALID	Indoor unit with automatically swing louwer
		INVALID	Indoor unit without automatically swing louwer
Remote control function13	I/U FAN	HI-MID-LO	Indoor unit with three step of air flow setting
		HI-LO	Indoor unit with two step of air flow setting
		HI-MID	
		1 FAN SPEED	Indoor unit with only one of air flow setting
Remote control function15	MODEL TYPE	HEAT PUMP	Heat pump unit
		COOLING ONLY	Exclusive cooling unit

Note 3: As for plural indoor unit, set indoor functions to each master and slave indoor unit.  
But only master indoor unit is received the setting change of indoor unit function "05 EXTERNAL INPUT" and "06 PERMISSION / PROHIBITION".

From previous page

(Indoor unit function) I/U FUNCTION ▲

Indoor unit No. are indicated only when plural indoor units are connected.

To set other indoor unit, press AIRCON NO. button, which allows you to go back to the indoor unit selection screen (for example: I/U 000 ▲).

Function	Setting	Initial Setting
*02 FAN SPEED SET	STANDARD HIGH SPEED 1 HIGH SPEED 2	※ ※
*03 FILTER SIGN SET	INDICATION OFF TYPE 1 TYPE 2 TYPE 3 TYPE 4	
04 POSITION	4 POSITION STOP FREE STOP	
05 EXTERNAL INPUT	LEVEL INPUT PULSE INPUT	
06 PERMISSION/PROHIBITION	INVALID VALID	
*07 EMERGENCY STOP	INVALID VALID	
*08 ※ SP OFFSET	OFFSET +3.0℃ OFFSET +2.0℃ OFFSET +1.0℃ NO OFFSET	
*09 RETURN AIR TEMP	OFFSET +2.0℃ OFFSET +1.5℃ OFFSET +1.0℃ NO OFFSET OFFSET -1.0℃ OFFSET -1.5℃ OFFSET -2.0℃	
*10 ※ FAN CONTROL	LOW FAN SPEED SET FAN SPEED INTERMITTENCE FAN OFF	
*11 FROST PREVENTION TEMP	TEMP HIGH TEMP LOW	
*12 FROST PREVENTION CONTROL	FAN CONTROL ON FAN CONTROL OFF	
*13 DRAIN PUMP LINK	※○ ※○AND※ ※○AND※AND※ ※○AND※	
*14 ※ FAN REMAINING	NO REMAINING 0.5 HOUR 1 HOUR 6 HOUR	
*15 ※ FAN REMAINING	NO REMAINING 0.5 HOUR 2 HOUR 6 HOUR	
*16 ※ FAN INTERMITTENCE	NO REMAINING 2min OFF 5min ON 5min OFF 5min ON	
*17 PRESSURE CONTROL	STANDARD TYPE1	※ ※

Note2: Fan setting of "HIGH SPEED"

Fan tap	Indoor unit air flow setting				
	STANDARD	UH - Hi - Me - Lo	Hi - Me - Lo	Hi - Lo	Hi - Me
FAN SPEED SET	HIGH SPEED1, 2	UH - UH - Hi - Me	UH - Hi - Me	UH - Me	UH - Hi

Initial function setting of some indoor unit is "HIGH SPEED".  
4 speed is not able to be set with wireless remote control.

The filter sign is indicated after running for 180 hours.  
The filter sign is indicated after running for 600 hours.  
The filter sign is indicated after running for 1000 hours.  
The filter sign is indicated after running for 1000 hours, then the indoor unit will be stopped by compulsion after 24 hours.

If you change the indoor function "04 POSITION", you must change the remote control function "14 POSITION" accordingly.  
You can select the louwer stop position in the four.  
The louwer can stop at any position.

Permission/prohibition control of operation will be valid.

With the VRF series, it is used to stop all indoor units connected with the same outdoor unit immediately. When stop signal is inputted from remote on-off terminal "CNT-6", all indoor units are stopped immediately.

To be reset for producing +3.0℃ increase in temperature during heating.  
To be reset for producing +2.0℃ increase in temperature during heating.  
To be reset for producing +1.0℃ increase in temperature during heating.

To be reset producing +2.0℃ increase in return air temperature of indoor unit.  
To be reset producing +1.5℃ increase in return air temperature of indoor unit.  
To be reset producing +1.0℃ increase in return air temperature of indoor unit.

To be reset producing -1.0℃ increase in return air temperature of indoor unit.  
To be reset producing -1.5℃ increase in return air temperature of indoor unit.  
To be reset producing -2.0℃ increase in return air temperature of indoor unit.

When heating thermostat is OFF, fan speed is low speed.  
When heating thermostat is OFF, fan speed is set speed.

When heating thermostat is OFF, fan speed is operated intermittently.  
When heating thermostat is OFF, the fan is stopped.  
When the remote thermostat is working, "FAN OFF" is set automatically.  
Do not set "FAN OFF" when the indoor unit's thermostat is working.

Change of indoor heat exchanger temperature to start frost prevention control.

Working only with the Single split series.  
To control frost prevention, the indoor fan tap is raised.

Drain pump is run during cooling and dry.  
Drain pump is run during cooling, dry and heating.  
Drain pump is run during cooling, dry, heating and fan.  
Drain pump is run during cooling, dry and fan.

After cooling is stopped, the fan does not perform extra operation.  
After cooling is stopped, the fan perform extra operation for half an hour.  
After cooling is stopped, the fan perform extra operation for an hour.  
After cooling is stopped, the fan perform extra operation for six hours.

After heating is stopped or heating thermostat is OFF, the fan does not perform extra operation.  
After heating is stopped or heating thermostat is OFF, the fan perform extra operation for half an hour.  
After heating is stopped or heating thermostat is OFF, the fan perform extra operation for two hours.  
After heating is stopped or heating thermostat is OFF, the fan perform extra operation for six hours.

During heating is stopped or heating thermostat is OFF, the fan perform intermittent operation for five minutes with low fan speed after twenty minutes' OFF.  
During heating is stopped or heating thermostat is OFF, the fan perform intermittent operation for five minutes with low fan speed after five minutes' OFF.

Connected "OA Processing" type indoor unit, and is automatically defined.

From previous page

**How to set function**

1. Stop air-conditioner and press (SET) (MODE) buttons at the same time for over three seconds, and the "FUNCTION SET ▼" will be displayed.



2. Press (SET) button.
3. Make sure which do you want to set, "FUNCTION ▼" (remote control function) or "I/U FUNCTION ▲" (indoor unit function).
4. Press ▲ or ▼ button.  
Select "FUNCTION ▼" (remote control function) or "I/U FUNCTION ▲" (indoor unit function).

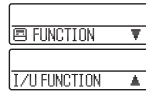

5. Press (SET) button.

**【On the occasion of remote control function selection】**

- ① "DATA LOADING" (Indication with blinking)  
↓  
Display is changed to "01 ESP SET".
- ② Press ▲ or ▼ button.  
"No. and function" are indicated by turns on the remote control function table, then you can select from them.  
(For example)

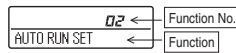

- ③ Press (SET) button.  
The current setting of selected function is indicated.  
(for example) "AUTO RUN ON" ← If "02 AUTO RUN SET" is selected

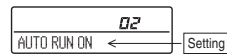

- ④ Press ▲ or ▼ button.  
Select the setting.

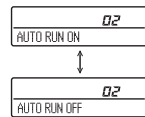

- ⑤ Press (SET) button.  
"SET COMPLETE" will be indicated, and the setting will be completed.  
Then after "No. and function" indication returns, Set as the same procedure if you want to set continuously, and if to finish, go to 7.



7. Press (ON/OFF) button.  
Setting is finished.

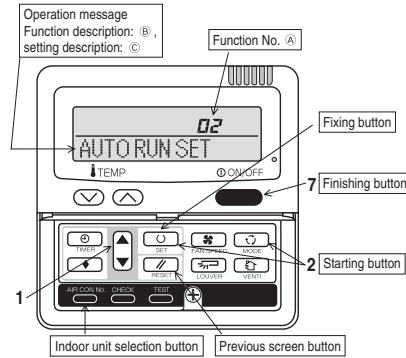

**【On the occasion of indoor unit function selection】**

- ① "DATA LOADING" (Blinking for 2 to 23 seconds to read the data)  
↓  
Indication is changed to "02 FAN SPEED SET".  
Go to ②.

**[Note]**

- (1) If plural indoor units are connected to a remote control, the indication is "I/U 000" (blinking) ← The lowest number of the indoor unit connected is indicated.

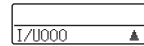

- (2) Press ▲ or ▼ button.  
Select the number of the indoor unit you are to set  
If you select "ALL UNIT ▼", you can set the same setting with all unites.

- (3) Press (SET) button.

- ② Press ▲ or ▼ button.  
"No. and function" are indicated by turns on the indoor unit function table, then you can select from them.  
(For example)

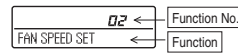

- ③ Press (SET) button.  
The current setting of selected function is indicated.  
(For example) "STANDARD" ← If "02 FAN SPEED SET" is selected.

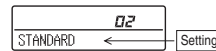

- ④ Press ▲ or ▼ button.  
Select the setting.

- ⑤ Press (SET) button.  
"SET COMPLETE" will be indicated, and the setting will be completed.  
Then after "No. and function" indication returns, set as the same procedure if you want to set continuously, and if to finish, go to 7.



※ When plural indoor units are connected to a remote control, press the [AIRCON NO.] button, which allows you to go back to the indoor unit selection screen. (example "I/U 000 ▲")

- It is possible to finish by pressing (ON/OFF) button on the way, but unfinished change of setting is unavailable.
- During setting, if you press (RESET) button, you return to the previous screen.
- Setting is memorized in the control and it is saved independently of power failure.

**【How to check the current setting】**

When you select from "No. and function" and press set button by the previous operation, the "Setting" displayed first is the current setting.  
(But, if you select "ALL UNIT ▼", the setting of the lowest number indoor unit is displayed.)



## (2) Interface kit (SC-BIKN-E)

RKZ012A088B

### Accessories included in package

Be sure to check all the accessories included in package.

No.	Part name	Quantity
①	Indoor unit's connection cable (cable length: 1.8m)	1
②	Wood screws (for mounting the interface: φ4X 25)	2
③	Tapping screws (for the cable clamp and the interface mounting bracket)	3
④	Interface mounting bracket	1
⑤	Cable clamp (for the indoor unit's connection cable)	1
⑥*	CNT terminal connection cable (total cable length: 0.5m)	1

\* SC-BIKN-EA only

### Safety precautions

Before use, please read these Safety Precautions thoroughly before installation.

- All the cautionary items mentioned below are important safety related items to be taken into consideration, so be sure to observe them at all times.

**Warning** Incorrect installation could lead to serious consequences such as death, major injury or environmental destruction.

- Symbols used in these precautions

**!** Always go along these instruction.

- After completed installation, carry out trial operation to confirm no anomaly, and ask the user to keep this installation manual in a good place for future reference.

## WARNING



- **Installation must be carried out by a qualified installer.**  
If you install it by yourself, it may cause an electric shock, fire and personal injury, as a result of a system malfunction.
- **Install it in full accordance with the instruction manual.**  
Incorrect installation may cause an electric shock, fire and personal injury.
- **Electrical work must be carried out by a qualified electrician in accordance with the technical standard for electrical equipment, the indoor wiring standard and this instruction manual.**  
Incorrect installation may cause an electric shock, fire and personal injury.
- **Use the specific cables for wiring. And connect all the cables to terminals or connectors securely and clamp them with cable clamps in order for external forces not to be transmitted to the terminals directly.**  
Incomplete connection may cause malfunction, and lead to heat generation and fire.
- **Use the original accessories and specified components for installation.**  
If the parts other than those prescribed by us are used, it may cause an electric shock, fire and personal injury.

### Connecting the indoor unit's connection cable to the interface

- ① Remove the upper case of the interface.
  - Remove 2 screws from the interface casing before removal of upper casing.
- ② Connect the indoor unit's connection cable to the interface.
  - Connect the connector of the indoor unit connection cable to the connector on the interface's circuit board.
- ③ Fix the indoor unit's connection cable with the cable clamp.
  - Cable can be brought in from the top or from the back.
  - Cut out the punch-outs for the connection cables running into the casing with cutter.
- ④ Connect the indoor unit's connection cable to the indoor control PCB.
  - Connect the indoor unit's connection cable to the indoor control PCB securely.
  - Clamp the connection cable to the indoor control box securely with the cable clamp provided as an accessory.
  - Regarding the cable connection to the indoor unit, refer to the instruction manual for indoor unit.

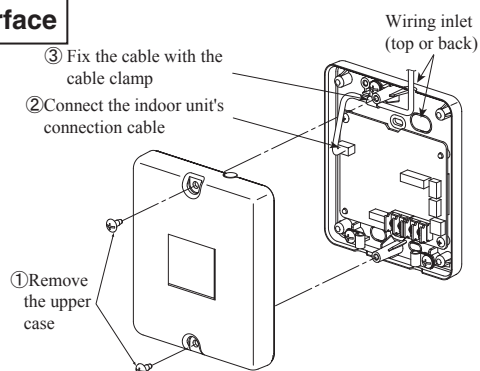

### Name of each part of the interface

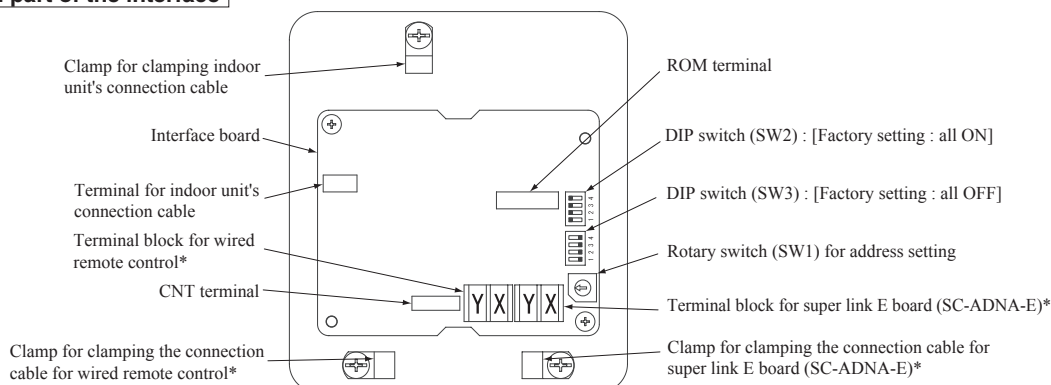

\*Either the connection cables of super link E board (SC-ADNA-E) or of wired remote control is connectable.

Switch	Setting	Function	Switch	Setting	Function
SW2-1	ON**	CNT level input	SW2-3	ON**	External input (CNT input)
	OFF	CNT Pulse input		OFF	Operation permission/prohibition (CNT input)
SW2-2	ON**	Wired remote control : Enable	SW2-4	ON**	Annual cooling : Enable***
	OFF	Wired remote control : Disable		OFF	Annual cooling : Disable***

\*\* Factory setting

\*\*\* Indoor fan control at low outdoor air temperature in cooling

### Installation of the interface

- Install the interface within the range of the connection cable length from the indoor unit. (approximately 1.8m)
- Be sure not to extend the connection cable on site. If the connection cable is extended, malfunction may occur.
- Fix the interface on the wall, pillar or the like.

- DO NOT install the interface and wired remote control at the following places.
  - Places exposed to direct sunlight
  - Places near heating devices
  - High humidity places
  - Surfaces where are enough hot or cold to generate condensation
  - Places exposed to oil mist or steam directly
  - Uneven surface

#### Mounting the interface directly on a wall

- ① Mount the lower casing of the interface on a flat surface with wood screws provided as standard accessory.
- ② Mount the upper casing.

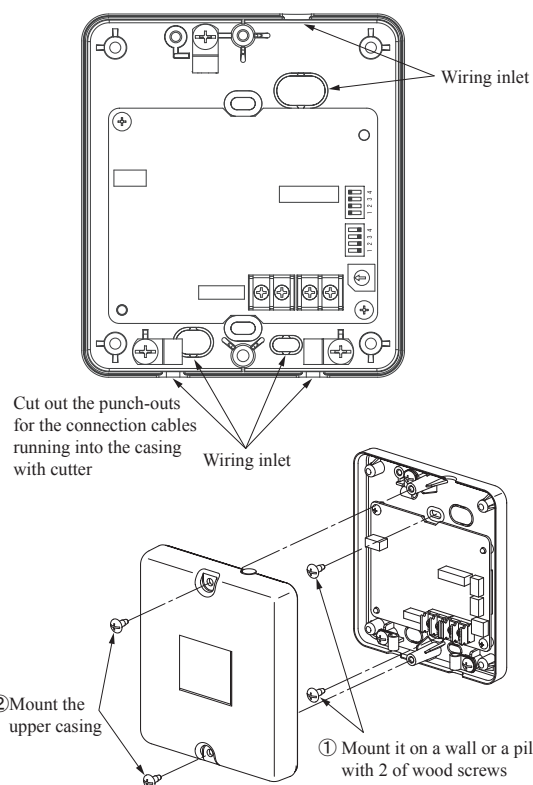

#### Recessing the interface in the wall

- ① Recess the electrical box (procured locally) and connection cables in the wall.
- ② Mount the lower casing of the interface to the electrical box with M4 screws (procured locally).
- ③ Mount the upper casing.

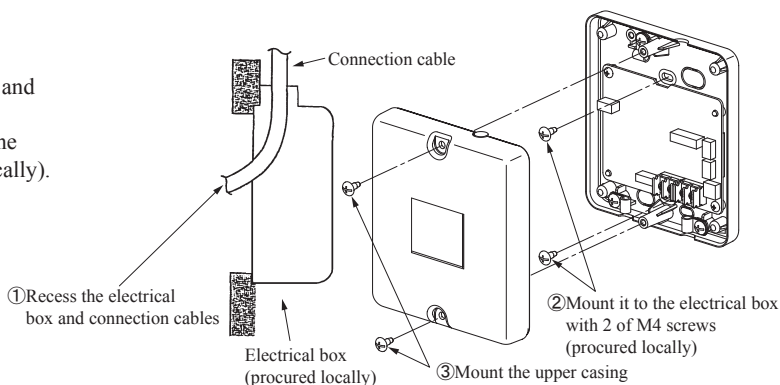

#### Mounting the interface with the mounting bracket

- ① Mount the mounting bracket to the interface with tapping screws provided as standard accessory.
- ② Mount the mounting bracket on wall or the like with wood screws provided as standard accessory.
- ③ Mount the mounting bracket to a wall surface, etc. using the wood screws provided.

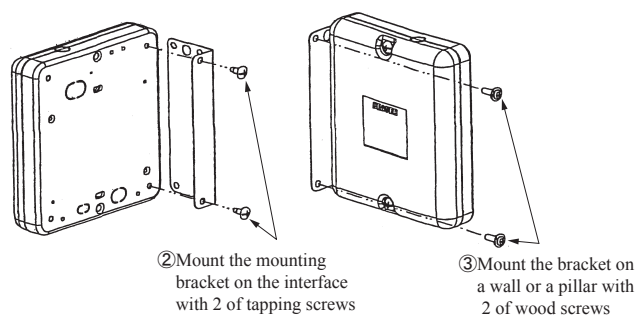

### Installation check items

- Are the connection cables connected securely to the terminal blocks and connectors?
- Are the thickness and length of the connection cables conformed with the standard?

### Functions of CNT connector

It is available to operate the air conditioning unit and to monitor the operation status with the external control unit (remote display) by sending the input/output signal through CNT connector on the indoor control PCB.

- ① Connect an external remote control unit (procured locally) to CNT terminal.
- ② In case of the pulse input, switch OFF the DIP switch SW2-1 on the interface PCB.
- ③ When setting operation permission/prohibition mode, switch OFF the DIP switch SW2-3 on the interface PCB.

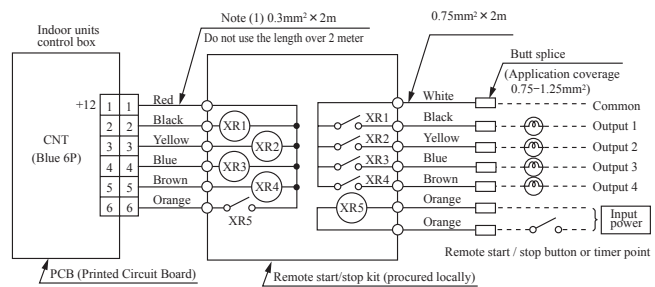

Input/Output	Function	Output signal		Content
		Relay	ON/OFF	
Output 1	Operation output	XR1	ON	During air-conditioner operation
Output 2	Heating output	XR2	ON	During heating operation
Output 3	Compressor operation output	XR3	ON	During compressor running
Output 4	Malfunction output	XR4	ON	During anomalous stop

- XR1-4 are for the DC 12V relay
- XR5 is a DC 12/24V or AC 220-240V relay
- CNT connector (local) maker, model

Connector	Molex	5264-06
Terminals	Molex	5263T

Input/Output	Function	SW2-1		SW2-3			Air-Conditioner	Operation by Remote Control			
		Setting		Setting	Input signal Level/Pulse	XR5			Content		
Input	External control input	ON*	Level input	ON*	Level	OFF→ON	External input	ON	Allowed		
						ON→OFF		OFF			
						OFF→ON		OFF			
		OFF	Pulse input	ON*	Pulse	ON*	Pulse	OFF→ON	External input	OFF→ON	Allowed
								ON→OFF		OFF	
								OFF→ON		ON	
OFF	Level	OFF	Level	OFF	Level	OFF→ON	Operation permission	ON	Not allowed		
						ON→OFF		OFF			

\* Factory setting

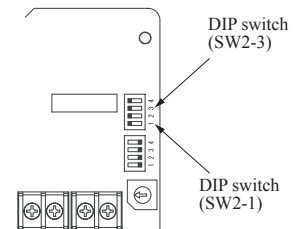

### Connection of super link E board

Regarding the connection of super link E board, refer to the instruction manual of super link E board.

For electrical work, power supply for all of units in the super link system must be turned OFF.

- ① Switch ON the DIP switch SW2-2 (Factory setting: ON) on the interface PCB.  
Caution: Wireless remote control attached to the indoor unit can be used in parallel, after connecting the wired remote control. However, some of functions other than the basic functions such as RUN/STOP, Temperature Setting, etc. may not work properly and may have a mismatch between the display and the actual behavior.

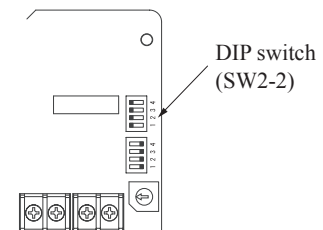

- ② Wiring connection between the interface and the super link E board.

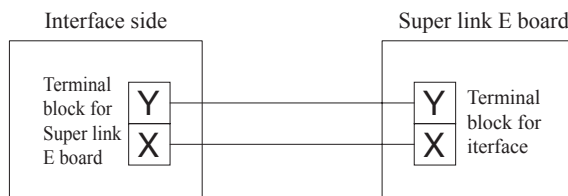

No.	Names of recommended signal wires
1	Shielded wire
2	Vinyl cabtyre round cord
3	Vinyl cabtyre round cable
4	Vinyl insulated wire/vinyl sheathed cable for control

Within 200 m 0.5 mm<sup>2</sup> × 2 cores  
 Within 300 m 0.75 mm<sup>2</sup> × 2 cores  
 Within 400 m 1.25 mm<sup>2</sup> × 2 cores  
 Within 600 m 2.0 mm<sup>2</sup> × 2 cores

- ③ Clamp the connection cables with cable clamps.

### Connection of wired remote control

Regarding the connection of wired remote control, refer to the instruction manual of wired remote control.

- Switch ON the DIP switch SW2-2 (Factory setting : ON) on the interface PCB.

Caution: Wireless remote control attached to the indoor unit can be used in parallel, after connecting the wired remote control. However, some of functions other than the basic functions such as RUN/STOP, Temperature Setting, etc. may not work properly and may have a mismatch between the display and the actual behavior.

- Wiring connection between the interface and the wired remote control.

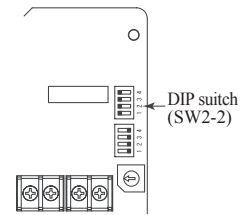

#### Installation and wiring of wired remote control

- Install the wired remote control with reference to the attached instruction manual of wired remote control.
  - 0.3mm<sup>2</sup> × 2-core cable should be used for the wiring of wired remote control.
  - Maximum length of wiring is 600m.  
If the length of wiring exceeds 100m, change the size of cable as mentioned below.  
100m-200m: 0.5mm<sup>2</sup> × 2-core, 300m or less: 0.75mm<sup>2</sup> × 2-core, 400m or less: 1.25mm<sup>2</sup> × 2-core, 600m or less: 2.0mm<sup>2</sup> × 2-core  
However, cable size connecting to the terminal of wired remote control should not exceed 0.5mm<sup>2</sup>. Accordingly if the size of connection cable exceeds 0.5mm<sup>2</sup>, be sure to downsize it to 0.5mm<sup>2</sup> at the nearest section of the wired remote control and waterproof treatment should be done at the connecting section in order to avoid contact failure.
  - Don't use the multi-core cable to avoid malfunction.
  - Keep the wiring of wired remote control away from grounding (Don't touch it to any metal frame of building, etc.).
  - Connect the connection cables to the terminal blocks of the wired remote control and the interface securely (no polarity).
- Clamp the connection cables with cable clamps.

#### Control of multiple units by a single wired remote control

Multiple units (up to 16) can be controlled by a single wired remote control. In this case, all units connected with a single wired remote control will operate under the same mode and same setting temperature.

- Connect all the interface with 2-core cables of wired remote control line.
- Set the address of indoor unit for remote control communication from "0" to "F" with the rotary switch SW1 on the interface PCB.
- After turning the power ON, the address of indoor unit can be displayed by pressing [AIR CON] button on the wired remote control.  
Make sure all indoor units connected are displayed in order by pressing or button.

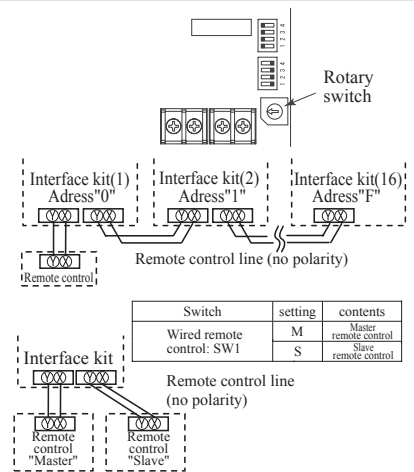

#### Master/Slave setting wired when 2 of wired remote control are used

- Maximum two wired remote control can be connected to one indoor unit (or one group of indoor units)
- Set the DIP switch SW1 on the wired remote control to "Slave" for the slave remote control. (Factory setting : Master)  
 O Caution : Remote control sensor is invalid.

- When using the wireless remote control in parallel with the wired remote control; Since temperature setting range of wired remote control is different from that of wireless remote control, please adjust the setting range of wired remote control to be the same setting range of wireless remote control by following procedure. (The set temperature may not be displayed correctly on the wireless remote control, unless change of temperature setting range is done.)  
Changing procedure of temperature setting range is as follows.

#### How to set upper and lower limit of temperature sting range

- Stop the air-conditioner, and press (SET) and (MODE) button at the same time for 3 seconds or more.  
The indication changes to "FUNCTION SET ▼"  
 2. Press button once, and change to the "TEMP RANGE ▲" indication.  
 3. Press (SET) button, and enter the temperature range setting mode.  
 4. Confirm that the "Upper limit ▼" is shown on the display.  
 5. Press (SET) button to fix.  
 6. ① Indication: "UPPER 28°C ▼ ▲"  
 ② Select the upper limit value 30°C with temperature setting button . "UPPER 30°C ▼" (blinking)  
 ③ Press (SET) button to fix. "UPPER 30°C" (Displayed for two seconds)  
 After the fixed upper limit value displayed for two seconds, the indication will return to "UPPER LIMIT ▼".  
 7. Press button once, "LOWER LIMIT ▲" is selected, press (SET) button to fix.  
 ① Indication: "LOWER 20°C ▼ ▲"  
 ② Select the lower limit value 18°C with temperature setting button . "LOWER 18°C ▲" (blinking)  
 ③ Press (SET) button to fix. "LOWER 18°C" (Displayed for two seconds)  
 After the fixed lower limit value displayed for two seconds, the indication will return to "LOWER LIMIT ▼"  
 8. Press [ON/OFF] button to finish.  
 Temperature setting range

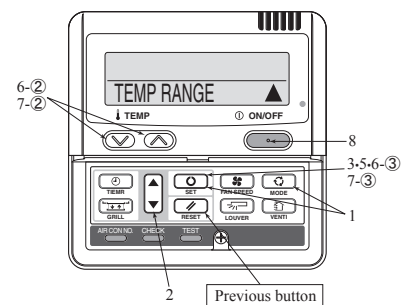

- It is possible to quit in the middle by pressing [ON/OFF] button, but the change of setting is incomplete.
- During setting, if pressing (RESET) button, it returns to the previous screen.

Mode	Temperature setting range
Cooling, Heating, Dry, Auto	18-30°C

### (3) Super link E board (SC-ADNA-E)

PJZ012D029F

- Read and understand the instructions completely before starting installation.
- Refer to the instructions for both indoor and outdoor units.

#### Safety precautions

- Carefully read "Safety precautions" first. Follow the instructions for installation.
- Precautions are grouped into "Warning⚠" and "Caution⚠". The "Warning⚠" group includes items that may lead to serious injury or death if not observed. The items included in the "Caution⚠" group also may lead to serious results under certain conditions. Both groups are crucial for safety installation. Read and understand them carefully.
- After installation, conduct the test operation of the device to check for any abnormalities. Describe how to operate the device to the customer following the installation instruction manual. Instruct the customer to keep this installation instruction for future reference.

**⚠WARNING**

- This device should be installed by the dealer where you purchase the device or a licensed professional shop. If the device is incorrectly installed by the customer, it may result in electric shock or fire.
- Install the device carefully following the installation instruction. If the device is incorrectly installed, it may result in electric shock or fire.
- Use the accessory parts and specified parts for installation. If any parts that do not match the specifications are used, it may result in electric shock or fire.
- A person with the electrical service certification should conduct the service based on the "Technical standards for electrical facilities", "Electrical Wiring Code", and the installation instruction. If the work is done incorrectly, it may result in electric shock or fire.
- Wiring should be securely connected using the specified types of wire. No external force on the wire should be applied to any terminals. If a secure connection is not achieved, it may result in electric shock or fire.

**⚠CAUTION**

- Provide ground connection.  
The ground line should never be connected to the gas supply piping, the water supply piping, the lightning conductor rod, nor the telephone ground. If the grounding is improper, it may result in electric shock.
- Do not install the device in the following locations.
  1. Where there is mist/spray of oil or steam such as kitchens.
  2. Where there is corrosive gases such as sulfuric acid gas.
  3. Where there is a device generating electromagnetic waves.  
These may interfere with the control system resulting in the device becoming uncontrollable.
  4. Where flammable volatile materials such as paint thinner and gasoline may exist or where they are handled. This may cause a fire.

#### 1 Application

Indoor-to-outdoor three core communication specification type 3 (since October 2007)

#### 2 Accessories

SL E board	Metal box	Metal cover	Screw for Ground
			M4x8L 2 pieces
Pan head screws	Locking supports	Binding band	Grommet
φ4x8L 2 pieces	To secure the print board and the metal box Made of nylon 4 pieces		

#### 5 Connection Outline

Note for setting the address

- Set the address between 00 and 47 for the previous Super Link connection and between 000 and 127 for the new Super Link connection. (\*1)
- Do not set the address overlapping with those of the other devices in the network. (The default is 000)

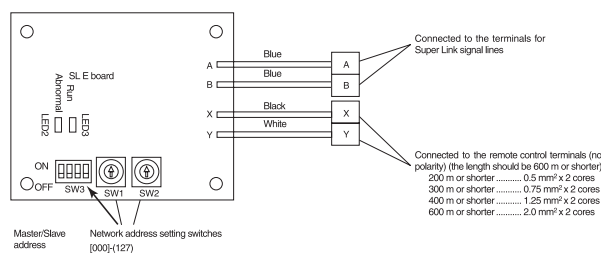

(\*1) Whether the actual link is either the new Super Link or the previous Super Link depends on the models of the connected outdoor and indoor units. Consult the agent or the dealer.

#### 3 Function

Allowing the center console SL1N-E, SL2N-E, and SL3N-AE/BE to control and monitor the commercial air conditioning unit.

#### 4 Control switching

Settings can be changed by the switch SW3 on the SL E board as in the following.

Switch	Symbol	Switch	Remarks
SW3	1	ON	Master
		OFF (default)	Slave
	2	ON	Fixed previous protocol
		OFF (default)	Automatic adjustment of Super Link protocol
	3	ON	Indicates the forced operation stop when abnormality has occurred.
		OFF (default)	Indicates the status of running/stop as it is, when abnormality has occurred.
	4	ON	The hundredth address activated "1"
		OFF (default)	The hundredth address activated "0"

Signal line specification

Communication method	Previous Super Link	New Super Link
Line type	MVVS	MVVS
Line diameter	0.75 - 1.25mm <sup>2</sup>	0.75/1.25mm <sup>2</sup>
Signal line (total length)	up to 1000m	up to 1500/1000m (*2)
Signal line (maximum length)	up to 1000m	up to 1000m

(\*2) Up to 1500 m for 0.75 mm<sup>2</sup>, and up to 1000 m for 1.25 mm<sup>2</sup>. Do not use 2.0 mm<sup>2</sup>. It may cause an error.

(\*3) Connect grounding on both ends of the shielding wire. For the grounding method, refer to the section "[6] Installation".



- Set the Super Link network address with SW1 (tens place), SW2 (ones place), and SW3 (hundreds place).
- Set the SL E board SW3-1 to be ON (Master) when using this without any remote control (no wired remote control nor wireless remote control).
- Set up the plural master/slave device using the dip switches on the indoor unit board.
- Set up the remote control master/slave device using the slide switch on the remote control board.
- Set up "0" to "F" using the address rotary switch on the indoor unit board when controlling the indoor unit with the multiple remote control.

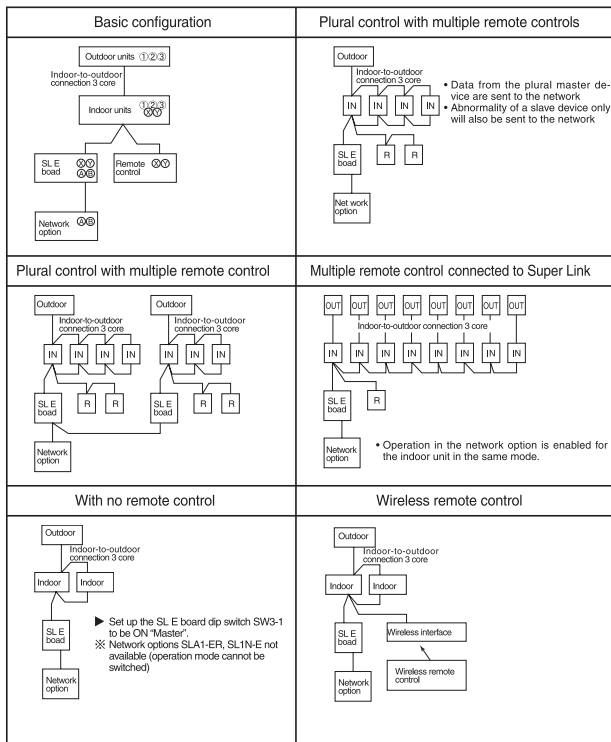

Connect grounding. Connect grounding for the power line to Ground ①, and grounding for the signal line to Ground ② or to the Ground on the indoor unit control box.

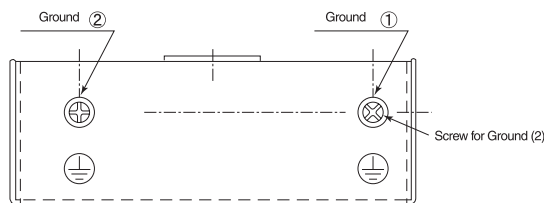

- When connecting to the indoor unit control box (ceiling-concealed type and FDT type only):

- Mount the SL E board in the control box using the locking supports.
- Remove 6 bands from the box and put the wiring through the bands to be secured.

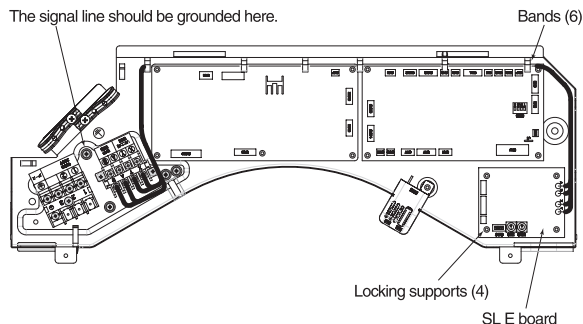

Electrical shock hazard! Make sure to turn the power off for servicing. Be cautious so that no abnormal force should be applied to the wiring. Do not damage the board with a screw driver.

The board is sensitive to static electricity. Release the static electricity of your body before servicing.  
(you can do this by touching the control board which is grounded).

**Location of installation**

Install the device at the location where there are no electromagnetic waves nor where there is water and dust. The specified temperature range of the device is 0 to 40°C. Install the device at the location where the ambient temperature stays within the range. If it exceeds the specification, make sure to provide solution such as installing a cooling fan. When used outside of the range, it may cause abnormal operation.

**6 Installation**

- When using the metal box (mounted on the indoor unit / mounted on the back of the remote control):

- Mount the SL E board in the metal box using the locking supports.
- Wiring should go through the provided grommet since then through the wiring to the hole on the Metal box.

Secure the grommet after inserting the grommet into the Metal box as shown in below figure, then tie the wiring at the outlet of the unit using a binding band.

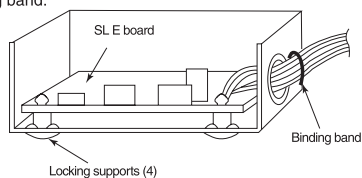

- ▲ When installed outside the indoor unit, put the metal cover on.

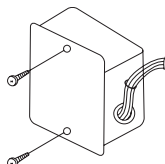

- ▲ When installed on the back of the remote control, mount it directly on the remote control bottom case.

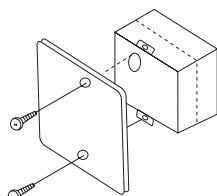

**7 Indicator display**

Check the LED 3 (green) and LED 2 (red) on the SL E board for flashing.

SL E board LEDs		Inspection mode	Display on the integrated network control device
Red	Green		
Off	Flashing	Normal communication	
Off	Off	<ul style="list-style-type: none"> <li>Disconnection in the remote control communication line (X or Y)</li> <li>Short-circuit in the remote control communication line (between X and Y)</li> <li>Faulty indoor unit remote control power</li> <li>Faulty remote control communication circuit</li> <li>Faulty CPU on SL E board</li> </ul>	No corresponding unit number
One flash	Flashing	<ul style="list-style-type: none"> <li>Disconnection in the Super Link signal line (A or B)</li> <li>Short-circuit in the Super Link signal line (between A and B)</li> <li>Faulty Super Link signal circuit</li> </ul>	
Two flashes	Flashing	<ul style="list-style-type: none"> <li>Faulty address setting for the SL E board (Set up the address for previous SL E board : more than 48 new SL E board : more than 128)</li> </ul>	
Three flashes	Flashing	<ul style="list-style-type: none"> <li>SL E board parent not set up when used without a remote control</li> <li>Faulty remote control communication circuit</li> </ul>	E1
Four flashes	Flashing	<ul style="list-style-type: none"> <li>Address overlapping for the SL E board and the Super Link network connected indoor unit</li> </ul>	E2
Off	Flashing	<ul style="list-style-type: none"> <li>Number of connected devices exceeds the specification for the multiple indoor unit control</li> </ul>	E10

PJZ012D029C

## 12. TECHNICAL INFORMATION

### Model SRK20ZM-S

Information to identify the model(s) to which the information relates to:				If function includes heating: Indicate the heating season the information relates to. Indicated values should relate to one heating season at a time. Include at least the heating season 'Average'.			
Indoor unit model name		SRK20ZM-S		Outdoor unit model name		SRC20ZM-S	
Function(indicate if present)				Average(mandatory)			
cooling		Yes		Warmer(if designated)		No	
heating		Yes		Colder(if designated)		No	
Item	symbol	value	unit	Item	symbol	value	class
Design load				Seasonal efficiency and energy efficiency class			
cooling	Pdesignc	2.00	kW	cooling	SEER	7.00	A++
heating / Average	Pdesignh	2.80	kW	heating / Average	SCOP/A	4.05	A+
heating / Warmer	Pdesignh	-	kW	heating / Warmer	SCOP/W	-	-
heating / Colder	Pdesignh	-	kW	heating / Colder	SCOP/C	-	-
				unit			
Declared capacity at outdoor temperature Tdesignh				Back up heating capacity at outdoor temperature Tdesignh			
heating / Average (-10°C)	Pdh	2.41	kW	heating / Average (-10°C)	elbu	0.39	kW
heating / Warmer (2°C)	Pdh	-	kW	heating / Warmer (2°C)	elbu	-	kW
heating / Colder (-22°C)	Pdh	-	kW	heating / Colder (-22°C)	elbu	-	kW
Declared capacity for cooling, at indoor temperature 27(19)°C and outdoor temperature Tj				Declared energy efficiency ratio, at indoor temperature 27(19)°C and outdoor temperature Tj			
Tj=35°C	Pdc	2.00	kW	Tj=35°C	EERd	4.55	-
Tj=30°C	Pdc	1.47	kW	Tj=30°C	EERd	7.20	-
Tj=25°C	Pdc	1.33	kW	Tj=25°C	EERd	10.40	-
Tj=20°C	Pdc	1.87	kW	Tj=20°C	EERd	10.80	-
Declared capacity for heating / Average season, at indoor temperature 20°C and outdoor temperature Tj				Declared coefficient of performance / Average season, at indoor temperature 20°C and outdoor temperature Tj			
Tj=-7°C	Pdh	2.48	kW	Tj=-7°C	COPd	2.40	-
Tj=2°C	Pdh	1.51	kW	Tj=2°C	COPd	4.20	-
Tj=7°C	Pdh	1.34	kW	Tj=7°C	COPd	5.50	-
Tj=12°C	Pdh	1.56	kW	Tj=12°C	COPd	6.70	-
Tj=bivalent temperature	Pdh	2.48	kW	Tj=bivalent temperature	COPd	2.40	-
Tj=operating limit	Pdh	2.30	kW	Tj=operating limit	COPd	2.10	-
Declared capacity for heating / Warmer season, at indoor temperature 20°C and outdoor temperature Tj				Declared coefficient of performance / Warmer season, at indoor temperature 20°C and outdoor temperature Tj			
Tj=2°C	Pdh	-	kW	Tj=2°C	COPd	-	-
Tj=7°C	Pdh	-	kW	Tj=7°C	COPd	-	-
Tj=12°C	Pdh	-	kW	Tj=12°C	COPd	-	-
Tj=bivalent temperature	Pdh	-	kW	Tj=bivalent temperature	COPd	-	-
Tj=operating limit	Pdh	-	kW	Tj=operating limit	COPd	-	-
Declared capacity for heating / Colder season, at indoor temperature 20°C and outdoor temperature Tj				Declared coefficient of performance / Colder season, at indoor temperature 20°C and outdoor temperature Tj			
Tj=-7°C	Pdh	-	kW	Tj=-7°C	COPd	-	-
Tj=2°C	Pdh	-	kW	Tj=2°C	COPd	-	-
Tj=7°C	Pdh	-	kW	Tj=7°C	COPd	-	-
Tj=12°C	Pdh	-	kW	Tj=12°C	COPd	-	-
Tj=bivalent temperature	Pdh	-	kW	Tj=bivalent temperature	COPd	-	-
Tj=operating limit	Pdh	-	kW	Tj=operating limit	COPd	-	-
Tj=-15°C	Pdh	-	kW	Tj=-15°C	COPd	-	-
Bivalent temperature				Operating limit temperature			
heating / Average	Tbiv	-7	°C	heating / Average	Tol	-15	°C
heating / Warmer	Tbiv	-	°C	heating / Warmer	Tol	-	°C
heating / Colder	Tbiv	-	°C	heating / Colder	Tol	-	°C
Cycling interval capacity				Cycling interval efficiency			
for cooling	Pcycc	-	kW	for cooling	EERcyc	-	-
for heating	Pcyh	-	kW	for heating	COPcyc	-	-
Degradation coefficient				Degradation coefficient			
cooling	Cdc	0.25	-	heating	Cdh	0.25	-
Electric power input in power modes other than 'active mode'				Annual electricity consumption			
off mode	Poff	5	W	cooling	Qce	101	kWh/a
standby mode	Psb	5	W	heating / Average	Qhe	968	kWh/a
thermostat-off mode	Pto	15	W	heating / Warmer	Qhe	-	kWh/a
crankcase heater mode	Pck	0	W	heating / colder	Qhe	-	kWh/a
Capacity control(indicate one of three options)				Other items			
fixed		No		Sound power level(indoor)	Lwa	49	dB(A)
staged		No		Sound power level(outdoor)	Lwa	59	dB(A)
variable		Yes		Global warming potential	GWP	1975	kgCO2eq.
				Rated air flow(indoor)	-	468	m3/h
				Rated air flow(outdoor)	-	1770	m3/h
Contact details for obtaining more information		Name and address of the manufacturer or of its authorised representative. Mitsubishi Heavy Industries Air-Conditioning Europe, Ltd. 7 Roundwood Avenue, Stockley Park, Uxbridge, Middlesex, UB11 1AX, United Kingdom					

B	RWA000Z253	
---	------------	---

**Model SRK25ZM-S**

Information to identify the model(s) to which the information relates to:				If function includes heating: Indicate the heating season the information relates to. Indicated values should relate to one heating season at a time. Include at least the heating season 'Average'.			
Indoor unit model name		SRK25ZM-S		Average(mandatory)		Yes	
Outdoor unit model name		SRC25ZM-S		Warmer(if designated)		No	
Function(indicate if present)				Colder(if designated)			
cooling		Yes					
heating		Yes					
Item	symbol	value	unit	Item	symbol	value	class
Design load				Seasonal efficiency and energy efficiency class			
cooling	Pdesignc	2.50	kW	cooling	SEER	7.10	A++
heating / Average	Pdesignh	2.90	kW	heating / Average	SCOP/A	4.16	A+
heating / Warmer	Pdesignh	-	kW	heating / Warmer	SCOP/W	-	-
heating / Colder	Pdesignh	-	kW	heating / Colder	SCOP/C	-	-
Declared capacity at outdoor temperature Tdesignh				Back up heating capacity at outdoor temperature Tdesignh			
heating / Average (-10°C)	Pdh	2.48	kW	heating / Average (-10°C)	elbu	0.42	kW
heating / Warmer (2°C)	Pdh	-	kW	heating / Warmer (2°C)	elbu	-	kW
heating / Colder (-22°C)	Pdh	-	kW	heating / Colder (-22°C)	elbu	-	kW
Declared capacity for cooling, at indoor temperature 27(19)°C and outdoor temperature Tj				Declared energy efficiency ratio, at indoor temperature 27(19)°C and outdoor temperature Tj			
Tj=35°C	Pdc	2.50	kW	Tj=35°C	EERd	4.03	-
Tj=30°C	Pdc	1.84	kW	Tj=30°C	EERd	6.55	-
Tj=25°C	Pdc	1.35	kW	Tj=25°C	EERd	10.50	-
Tj=20°C	Pdc	1.91	kW	Tj=20°C	EERd	11.00	-
Declared capacity for heating / Average season, at indoor temperature 20°C and outdoor temperature Tj				Declared coefficient of performance / Average season, at indoor temperature 20°C and outdoor temperature Tj			
Tj=-7°C	Pdh	2.57	kW	Tj=-7°C	COPd	2.50	-
Tj=2°C	Pdh	1.56	kW	Tj=2°C	COPd	4.30	-
Tj=7°C	Pdh	1.35	kW	Tj=7°C	COPd	5.60	-
Tj=12°C	Pdh	1.57	kW	Tj=12°C	COPd	6.80	-
Tj=bivalent temperature	Pdh	2.57	kW	Tj=bivalent temperature	COPd	2.50	-
Tj=operating limit	Pdh	2.33	kW	Tj=operating limit	COPd	2.20	-
Declared capacity for heating / Warmer season, at indoor temperature 20°C and outdoor temperature Tj				Declared coefficient of performance / Warmer season, at indoor temperature 20°C and outdoor temperature Tj			
Tj=2°C	Pdh	-	kW	Tj=2°C	COPd	-	-
Tj=7°C	Pdh	-	kW	Tj=7°C	COPd	-	-
Tj=12°C	Pdh	-	kW	Tj=12°C	COPd	-	-
Tj=bivalent temperature	Pdh	-	kW	Tj=bivalent temperature	COPd	-	-
Tj=operating limit	Pdh	-	kW	Tj=operating limit	COPd	-	-
Declared capacity for heating / Colder season, at indoor temperature 20°C and outdoor temperature Tj				Declared coefficient of performance / Colder season, at indoor temperature 20°C and outdoor temperature Tj			
Tj=-7°C	Pdh	-	kW	Tj=-7°C	COPd	-	-
Tj=2°C	Pdh	-	kW	Tj=2°C	COPd	-	-
Tj=7°C	Pdh	-	kW	Tj=7°C	COPd	-	-
Tj=12°C	Pdh	-	kW	Tj=12°C	COPd	-	-
Tj=bivalent temperature	Pdh	-	kW	Tj=bivalent temperature	COPd	-	-
Tj=operating limit	Pdh	-	kW	Tj=operating limit	COPd	-	-
Tj=-15°C	Pdh	-	kW	Tj=-15°C	COPd	-	-
Bivalent temperature				Operating limit temperature			
heating / Average	Tbiv	-7	°C	heating / Average	Tol	-15	°C
heating / Warmer	Tbiv	-	°C	heating / Warmer	Tol	-	°C
heating / Colder	Tbiv	-	°C	heating / Colder	Tol	-	°C
Cycling interval capacity				Cycling interval efficiency			
for cooling	Pcycc	-	kW	for cooling	EERcyc	-	-
for heating	Pcyh	-	kW	for heating	COPcyc	-	-
Degradation coefficient				Degradation coefficient			
cooling	Cdc	0.25	-	heating	Cdh	0.25	-
Electric power input in power modes other than 'active mode'				Annual electricity consumption			
off mode	Poff	5	W	cooling	Qce	124	kWh/a
standby mode	Psb	5	W	heating / Average	Qhe	977	kWh/a
thermostat-off mode	Pto	17	W	heating / Warmer	Qhe	-	kWh/a
crankcase heater mode	Pck	0	W	heating / colder	Qhe	-	kWh/a
Capacity control(indicate one of three options)				Other items			
fixed		No		Sound power level(indoor)	Lwa	50	dB(A)
staged		No		Sound power level(outdoor)	Lwa	60	dB(A)
variable		Yes		Global warming potential	GWP	1975	kgCO2eq.
				Rated air flow(indoor)	-	474	m3/h
				Rated air flow(outdoor)	-	1926	m3/h
Contact details for obtaining more information	Name and address of the manufacturer or of its authorised representative. Mitsubishi Heavy Industries Air-Conditioning Europe, Ltd. 7 Roundwood Avenue, Stockley Park, Uxbridge, Middlesex, UB11 1AX, United Kingdom						

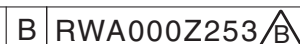



**Model SRK35ZM-S**

Information to identify the model(s) to which the information relates to:				If function includes heating: Indicate the heating season the information relates to. Indicated values should relate to one heating season at a time. Include at least the heating season 'Average'.			
Indoor unit model name		SRK35ZM-S		Average(mandatory)		Yes	
Outdoor unit model name		SRC35ZM-S		Warmer(if designated)		No	
Function(indicate if present)				Colder(if designated)			
cooling		Yes					
heating		Yes					
Item	symbol	value	unit	Item	symbol	value	class
Design load				Seasonal efficiency and energy efficiency class			
cooling	Pdesignc	3.50	kW	cooling	SEER	7.10	A++
heating / Average	Pdesignh	3.20	kW	heating / Average	SCOP/A	4.17	A+
heating / Warmer	Pdesignh	-	kW	heating / Warmer	SCOP/W	-	-
heating / Colder	Pdesignh	-	kW	heating / Colder	SCOP/C	-	-
Declared capacity at outdoor temperature Tdesignh				Back up heating capacity at outdoor temperature Tdesignh			
heating / Average (-10°C)	Pdh	2.78	kW	heating / Average (-10°C)	elbu	0.42	kW
heating / Warmer (2°C)	Pdh	-	kW	heating / Warmer (2°C)	elbu	-	kW
heating / Colder (-22°C)	Pdh	-	kW	heating / Colder (-22°C)	elbu	-	kW
Declared capacity for cooling, at indoor temperature 27(19)°C and outdoor temperature Tj				Declared energy efficiency ratio, at indoor temperature 27(19)°C and outdoor temperature Tj			
Tj=35°C	Pdc	3.50	kW	Tj=35°C	EERd	3.47	-
Tj=30°C	Pdc	2.58	kW	Tj=30°C	EERd	5.70	-
Tj=25°C	Pdc	1.66	kW	Tj=25°C	EERd	10.90	-
Tj=20°C	Pdc	2.08	kW	Tj=20°C	EERd	12.80	-
Declared capacity for heating / Average season, at indoor temperature 20°C and outdoor temperature Tj				Declared coefficient of performance / Average season, at indoor temperature 20°C and outdoor temperature Tj			
Tj=-7°C	Pdh	2.83	kW	Tj=-7°C	COPd	2.40	-
Tj=2°C	Pdh	1.72	kW	Tj=2°C	COPd	4.30	-
Tj=7°C	Pdh	1.47	kW	Tj=7°C	COPd	5.80	-
Tj=12°C	Pdh	1.73	kW	Tj=12°C	COPd	7.10	-
Tj=bivalent temperature	Pdh	2.83	kW	Tj=bivalent temperature	COPd	2.40	-
Tj=operating limit	Pdh	2.70	kW	Tj=operating limit	COPd	2.20	-
Declared capacity for heating / Warmer season, at indoor temperature 20°C and outdoor temperature Tj				Declared coefficient of performance / Warmer season, at indoor temperature 20°C and outdoor temperature Tj			
Tj=2°C	Pdh	-	kW	Tj=2°C	COPd	-	-
Tj=7°C	Pdh	-	kW	Tj=7°C	COPd	-	-
Tj=12°C	Pdh	-	kW	Tj=12°C	COPd	-	-
Tj=bivalent temperature	Pdh	-	kW	Tj=bivalent temperature	COPd	-	-
Tj=operating limit	Pdh	-	kW	Tj=operating limit	COPd	-	-
Declared capacity for heating / Colder season, at indoor temperature 20°C and outdoor temperature Tj				Declared coefficient of performance / Colder season, at indoor temperature 20°C and outdoor temperature Tj			
Tj=-7°C	Pdh	-	kW	Tj=-7°C	COPd	-	-
Tj=2°C	Pdh	-	kW	Tj=2°C	COPd	-	-
Tj=7°C	Pdh	-	kW	Tj=7°C	COPd	-	-
Tj=12°C	Pdh	-	kW	Tj=12°C	COPd	-	-
Tj=bivalent temperature	Pdh	-	kW	Tj=bivalent temperature	COPd	-	-
Tj=operating limit	Pdh	-	kW	Tj=operating limit	COPd	-	-
Tj=-15°C	Pdh	-	kW	Tj=-15°C	COPd	-	-
Bivalent temperature				Operating limit temperature			
heating / Average	Tbiv	-7	°C	heating / Average	Tol	-15	°C
heating / Warmer	Tbiv	-	°C	heating / Warmer	Tol	-	°C
heating / Colder	Tbiv	-	°C	heating / Colder	Tol	-	°C
Cycling interval capacity				Cycling interval efficiency			
for cooling	Pcycc	-	kW	for cooling	EERcyc	-	-
for heating	Pcyh	-	kW	for heating	COPcyc	-	-
Degradation coefficient				Degradation coefficient			
cooling	Cdc	0.25	-	heating	Cdh	0.25	-
Electric power input in power modes other than 'active mode'				Annual electricity consumption			
off mode	Poff	7	W	cooling	Qce	173	kWh/a
standby mode	Psb	7	W	heating / Average	Qhe	1074	kWh/a
thermostat-off mode	Pto	27	W	heating / Warmer	Qhe	-	kWh/a
crankcase heater mode	Pck	0	W	heating / colder	Qhe	-	kWh/a
Capacity control(indicate one of three options)				Other items			
fixed		No		Sound power level(indoor)	Lwa	58	dB(A)
staged		No		Sound power level(outdoor)	Lwa	62	dB(A)
variable		Yes		Global warming potential	GWP	1975	kgCO2eq.
				Rated air flow(indoor)	-	606	m3/h
				Rated air flow(outdoor)	-	1890	m3/h
Contact details for obtaining more information	Name and address of the manufacturer or of its authorised representative. Mitsubishi Heavy Industries Air-Conditioning Europe, Ltd. 7 Roundwood Avenue, Stockley Park, Uxbridge, Middlesex, UB11 1AX, United Kingdom						

B RWA000Z253 

**Model SRK50ZM-S**

Information to identify the model(s) to which the information relates to:				If function includes heating: Indicate the heating season the information relates to. Indicated values should relate to one heating season at a time. Include at least the heating season 'Average'.			
Indoor unit model name		SRK50ZM-S		Average(mandatory)		Yes	
Outdoor unit model name		SRC50ZM-S		Warmer(if designated)		No	
Function(indicate if present)				Colder(if designated)			
cooling		Yes					
heating		Yes					
Item	symbol	value	unit	Item	symbol	value	class
Design load				Seasonal efficiency and energy efficiency class			
cooling	Pdesignc	5.00	kW	cooling	SEER	6.30	A++
heating / Average	Pdesignh	4.70	kW	heating / Average	SCOP/A	4.20	A+
heating / Warmer	Pdesignh	-	kW	heating / Warmer	SCOP/W	-	-
heating / Colder	Pdesignh	-	kW	heating / Colder	SCOP/C	-	-
Declared capacity at outdoor temperature Tdesignh				Back up heating capacity at outdoor temperature Tdesignh			
heating / Average (-10°C)	Pdh	4.13	kW	heating / Average (-10°C)	elbu	0.57	kW
heating / Warmer (2°C)	Pdh	-	kW	heating / Warmer (2°C)	elbu	-	kW
heating / Colder (-22°C)	Pdh	-	kW	heating / Colder (-22°C)	elbu	-	kW
Declared capacity for cooling, at indoor temperature 27(19)°C and outdoor temperature Tj				Declared energy efficiency ratio, at indoor temperature 27(19)°C and outdoor temperature Tj			
Tj=35°C	Pdc	5.00	kW	Tj=35°C	EERd	3.23	-
Tj=30°C	Pdc	3.68	kW	Tj=30°C	EERd	5.30	-
Tj=25°C	Pdc	2.37	kW	Tj=25°C	EERd	8.85	-
Tj=20°C	Pdc	3.08	kW	Tj=20°C	EERd	9.30	-
Declared capacity for heating / Average season, at indoor temperature 20°C and outdoor temperature Tj				Declared coefficient of performance / Average season, at indoor temperature 20°C and outdoor temperature Tj			
Tj=-7°C	Pdh	4.16	kW	Tj=-7°C	COPd	2.40	-
Tj=2°C	Pdh	2.53	kW	Tj=2°C	COPd	4.40	-
Tj=7°C	Pdh	1.92	kW	Tj=7°C	COPd	5.75	-
Tj=12°C	Pdh	2.84	kW	Tj=12°C	COPd	6.30	-
Tj=bivalent temperature	Pdh	4.16	kW	Tj=bivalent temperature	COPd	2.40	-
Tj=operating limit	Pdh	4.09	kW	Tj=operating limit	COPd	2.20	-
Declared capacity for heating / Warmer season, at indoor temperature 20°C and outdoor temperature Tj				Declared coefficient of performance / Warmer season, at indoor temperature 20°C and outdoor temperature Tj			
Tj=2°C	Pdh	-	kW	Tj=2°C	COPd	-	-
Tj=7°C	Pdh	-	kW	Tj=7°C	COPd	-	-
Tj=12°C	Pdh	-	kW	Tj=12°C	COPd	-	-
Tj=bivalent temperature	Pdh	-	kW	Tj=bivalent temperature	COPd	-	-
Tj=operating limit	Pdh	-	kW	Tj=operating limit	COPd	-	-
Declared capacity for heating / Colder season, at indoor temperature 20°C and outdoor temperature Tj				Declared coefficient of performance / Colder season, at indoor temperature 20°C and outdoor temperature Tj			
Tj=-7°C	Pdh	-	kW	Tj=-7°C	COPd	-	-
Tj=2°C	Pdh	-	kW	Tj=2°C	COPd	-	-
Tj=7°C	Pdh	-	kW	Tj=7°C	COPd	-	-
Tj=12°C	Pdh	-	kW	Tj=12°C	COPd	-	-
Tj=bivalent temperature	Pdh	-	kW	Tj=bivalent temperature	COPd	-	-
Tj=operating limit	Pdh	-	kW	Tj=operating limit	COPd	-	-
Tj=-15°C	Pdh	-	kW	Tj=-15°C	COPd	-	-
Bivalent temperature				Operating limit temperature			
heating / Average	Tbiv	-7	°C	heating / Average	Tol	-15	°C
heating / Warmer	Tbiv	-	°C	heating / Warmer	Tol	-	°C
heating / Colder	Tbiv	-	°C	heating / Colder	Tol	-	°C
Cycling interval capacity				Cycling interval efficiency			
for cooling	Pcycc	-	kW	for cooling	EERcyc	-	-
for heating	Pcyh	-	kW	for heating	COPcyc	-	-
Degradation coefficient				Degradation coefficient			
cooling	Cdc	0.25	-	heating	Cdh	0.25	-
Electric power input in power modes other than 'active mode'				Annual electricity consumption			
off mode	Poff	5	W	cooling	Qce	278	kWh/a
standby mode	Psb	5	W	heating / Average	Qhe	1568	kWh/a
thermostat-off mode	Pto	40	W	heating / Warmer	Qhe	-	kWh/a
crankcase heater mode	Pck	0	W	heating / colder	Qhe	-	kWh/a
Capacity control(indicate one of three options)				Other items			
fixed		No		Sound power level(indoor)	Lwa	60	dB(A)
staged		No		Sound power level(outdoor)	Lwa	61	dB(A)
variable		Yes		Global warming potential	GWP	1975	kgCO2eq.
				Rated air flow(indoor)	-	678	m3/h
				Rated air flow(outdoor)	-	2160	m3/h
Contact details for obtaining more information	Name and address of the manufacturer or of its authorised representative. Mitsubishi Heavy Industries Air-Conditioning Europe, Ltd. 7 Roundwood Avenue, Stockley Park, Uxbridge, Middlesex, UB11 1AX, United Kingdom						

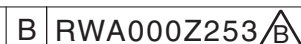

---

# **INVERTER WALL MOUNTED TYPE RESIDENTIAL AIR-CONDITIONERS**

---



---

Air-Conditioning & Refrigeration Systems

16-5, Konan 2-chome, Minato-ku, Tokyo, 108-8215 Japan

<http://www.mhi.co.jp>

Because of our policy of continuous improvement, we reserve the right to make changes in all specifications without notice.

© Copyright MITSUBISHI HEAVY INDUSTRIES, LTD.